

AIR CONDITIONER INDOOR UNIT Compact Wall Mounted Type

INSTALLATION MANUAL

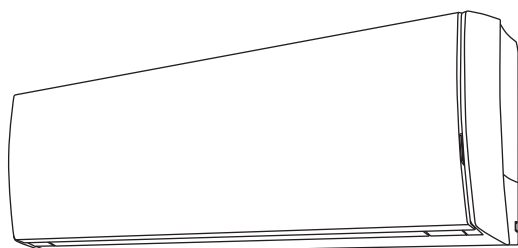

INSTALLATION MANUAL

For authorized service personnel only.

English

INSTALLATIONSANLEITUNG

Nur für autorisiertes Personal.

Deutsch

MANUEL D'INSTALLATION

Pour le personnel agréé uniquement.

Français

MANUAL DE INSTALACIÓN

Solo para personal autorizado.

Español

MANUALE D'INSTALLAZIONE

Ad uso esclusivo del personale autorizzato.

Italiano

ΕΓΧΕΙΡΙΔΙΟ ΕΓΚΑΤΑΣΤΑΣΗΣ

Για εξουσιοδοτημένο προσωπικό σέρβις.

Ελληνικά

MANUAL DE INSTALAÇÃO

Apenas para técnicos autorizados.

Português

РУКОВОДСТВО ПО УСТАНОВКЕ

Для уполномоченного персонала.

Русский

KURULUM KILAVUZU

Yetkili servis personeli içindir.

Türkçe

Contents

1. SAFETY PRECAUTIONS.....	1
2. ABOUT THE UNIT.....	1
3. GENERAL SPECIFICATION.....	2
4. ELECTRICAL REQUIREMENT.....	2
5. SELECTING THE MOUNTING POSITION.....	3
6. INSTALLATION WORK.....	3
7. ELECTRICAL WIRING.....	6
8. FINISHING.....	7
9. FRONT PANEL REMOVAL AND INSTALLATION.....	7
10. TEST RUN.....	8
11. REMOTE CONTROLLER INSTALLATION.....	8
12. OPTIONAL KIT INSTALLATION (UTY-TWBXF).....	9
13. SELECTING THE REMOTE CONTROLLER SIGNAL CODE.....	10
14. FUNCTION SETTING.....	10
15. CUSTOMER GUIDANCE.....	11
16. ERROR CODES.....	11

• Branch box which is specified in this manual is the equipment to support the indoor unit of multi-connection type.

1. SAFETY PRECAUTIONS

- Be sure to read this manual thoroughly before installation.
- The warnings and precautions indicated in this manual contain important information pertaining to your safety. Be sure to observe them.
- Hand this manual, together with the operating manual, to the customer. Request the customer to keep them on hand for future use, such as for relocating or repairing the unit.

 WARNING	This mark indicates procedures which, if improperly performed, might lead to the death or serious injury of the user.
Request your dealer or a professional installer to install the indoor unit in accordance with this installation manual. An improperly installed unit can cause serious accidents such as water leakage, electric shock, or fire. If the indoor unit is installed in disregard of the instructions in the installation manual, it will void the manufacturer's warranty.	
Do not turn ON the power until all work has been completed. Turning ON the power before the work is completed can cause serious accidents such as electric shock or fire.	
If refrigerant leaks while work is being carried out, ventilate the area. If the refrigerant comes in contact with a flame, it produces a toxic gas.	
Installation work must be performed in accordance with national wiring standards by authorized personnel only.	

 CAUTION	This mark indicates procedures which, if improperly performed, might possibly result in personal harm to the user, or damage to property.
Read carefully all security information before use or install the air conditioner.	
Do not attempt to install the air conditioner or a part of the air conditioner by yourself.	
This unit must be installed by qualified personnel with a capacity certificate for handling refrigerant fluids. Refer to regulation and laws in use on installation place.	
The installation must be carried out in compliance with regulations in force in the place of installation and the installation instructions of the manufacturer.	
This unit is part of a set constituting an air conditioner. It must not be installed alone or with non-authorized by the manufacturer.	
Always use a separate power supply line protected by a circuit breaker operating on all wires with a distance between contact of 3 mm for this unit.	

The unit must be correctly grounded and the supply line must be equipped with a differential breaker in order to protect the persons.
The units are not explosion proof and therefore should not be installed in explosive atmosphere.
Never touch electrical components immediately after the power supply has been turned off. Electric shock may occur. After turning off the power, always wait 5 minutes before touching electrical components.
This unit contains no user-serviceable parts. Always consult authorized service personnel to repairs.
When moving, consult authorized service personnel for disconnection and installation of the unit.

2. ABOUT THE UNIT

2.1. Precautions for using R410A refrigerant

The basic installation work procedures are the same as conventional refrigerant (R22) models. However, pay careful attention to the following points:
Since the working pressure is 1.6 times higher than that of conventional refrigerant (R22) models, some of the piping and installation and service tools are special. (See the table below.) Especially, when replacing a conventional refrigerant (R22) model with a new refrigerant R410A model, always replace the conventional piping and flare nuts with the R410A piping and flare nuts.
Models that use refrigerant R410A have a different charging port thread diameter to prevent erroneous charging with conventional refrigerant (R22) and for safety. Therefore, check beforehand. [The charging port thread diameter for R410A is 1/2 inch.]
Be more careful that foreign matter (oil, water, etc.) does not enter the piping than with refrigerant (R22) models. Also, when storing the piping, securely seal the opening by pinching, taping, etc.
When charging the refrigerant, take into account the slight change in the composition of the gas and liquid phases. And always charge from the liquid phase where refrigerant composition is stable.

2.2. Special tools for R410A

Tool name	Contents of change
Gauge manifold	Pressure is high and cannot be measured with a conventional (R22) gauge. To prevent erroneous mixing of other refrigerants, the diameter of each port has been changed. It is recommended the gauge with seals -0.1 to 5.3 MPa (-1 to 53 bar) for high pressure. -0.1 to 3.8 MPa (-1 to 38 bar) for low pressure.
Charge hose	To increase pressure resistance, the hose material and base size were changed.
Vacuum pump	A conventional vacuum pump can be used by installing a vacuum pump adapter.
Gas leakage detector	Special gas leakage detector for HFC refrigerant R410A.

Copper pipes

It is necessary to use seamless copper pipes and it is desirable that the amount of residual oil is less than 40 mg/10 m. Do not use copper pipes having a collapsed, deformed or discolored portion (especially on the interior surface). Otherwise, the expansion valve or capillary tube may become blocked with contaminants.
As an air conditioner using R410A incurs pressure higher than when using R22, it is necessary to choose adequate materials.

 WARNING
Do not use the existing (for R22) piping and flare nuts. If the existing materials are used, the pressure inside the refrigerant cycle will rise and cause failure, injury, etc. (Use the special R410A materials.)
When installing and relocating the air conditioner, do not mix gases other than the specified refrigerant (R410A) to enter the refrigerant cycle. If air or other gas enters the refrigerant cycle, the pressure inside the cycle will rise to an abnormally high value and cause failure, injury, etc.

2.3. For authorized service personnel only.

WARNING

For the air conditioner to operate satisfactorily, install it as outlined in this installation manual.

Connect the indoor unit and outdoor unit or branch box with the air conditioner piping and cables available from your local distributor. This installation manual describes the correct connections using the installation set available from your local distributor.

Do not turn on the power until all installation work is complete.







CAUTION

This installation manual describes how to install the indoor unit only. To install the outdoor unit or branch box, refer to the installation manual included with the outdoor unit or branch box.

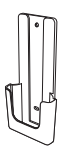
- Be careful not to scratch the air conditioner when handling it.
- After installation, explain correct operation to the customer, using the operating manual.

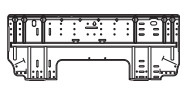
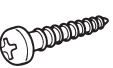
2.4. Accessories

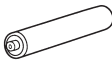
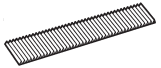
The following installation accessories are supplied. Use them as required.

Name and Shape	Q'ty	Name and Shape	Q'ty
Operating manual 	1	Remote controller holder 	1
Installation manual (This manual) 	1	Cloth tape 	1
Wall hook bracket 	1	Tapping screw (M4 × 25 mm) 	5
Remote controller 	1	Tapping screw (M3 × 12 mm) 	2
Battery 	2	Air cleaning filter 	2
Seal A  It is used when the diameter of gas pipe is Ø12.70 or more. It is necessary when using AS14.	1		

The following items are necessary to install this air conditioner. (The items are not included with the air conditioner and must be purchased separately.)

Name	Q'ty	Name	Q'ty
Connection pipe assembly	1	Wall cap	1
Connection cable (4-conductor)	1	Saddle	1 set
Wall pipe	1	Drain hose	1
Decorative tape	1	Tapping screws	1 set
Vinyl tape	1	Sealant	1

2.5. Optional parts

Refer to each installation manual for the method of installing optional parts.

Parts name	Model No.	Application
Wired remote controller *	UTY-RNN*M	For air conditioner operation
Simple remote controller *	UTY-RSN*M	For air conditioner operation
External connect kit *	UTY-XWZXZ5	For control input/output port
Communication kit	UTY-TWBXF	For the installation of optional parts

* Optional communication kit is necessary for the installation.

3. GENERAL SPECIFICATION

This installation manual briefly outlines where and how to install the air conditioning system. Please read over the entire set of instructions for the indoor and outdoor units and make sure all accessory parts listed are with the system before beginning.

3.1. Type of copper pipe and insulation material

CAUTION

Refer to the installation manual for the outdoor unit for description of allowable pipe length and height difference.

Selecting pipe sizes

The diameters of the connection pipes according to the capacity of the indoor unit. Refer to the following table for the proper diameters of the connection pipes between the indoor unit and outdoor unit or branch box.

Capacity of indoor unit	Gas pipe size (thickness) [mm]	Liquid pipe size (thickness) [mm]
7, 9, 12	Ø 9.52(0.8)	Ø 6.35(0.8)
14	Ø 12.70(0.8)	Ø 6.35(0.8)

CAUTION

Install heat insulation around both the gas and liquid pipes. Failure to do so may cause water leaks.
Use heat insulation with heat resistance above 120 °C. Reverse cycle model only)
In addition, if the humidity level at the installation location of the refrigerant piping is expected to exceed 70%, install heat insulation around the refrigerant piping. If the expected humidity level is 70-80%, use heat insulation that is 15 mm or thicker and if the expected humidity exceeds 80%, use heat insulation that is 20 mm or thicker.
If heat insulation is used that is not as thick as specified, condensation may form on the surface of the insulation.
In addition, use heat insulation with heat conductivity of 0.045 W/(m·K) or less 20 °C.

3.2. Additional materials required for installation

- Refrigeration (armored) tape
- Insulated staples or clamps for connecting wire (See your local electrical codes.)
- Putty
- Refrigeration lubricant
- Clamps or saddles to secure refrigerant piping

4. ELECTRICAL REQUIREMENT

The indoor unit is powered from the outdoor unit or branch box. Do not power indoor unit from separate power source.

WARNING

Refer to local codes for acceptable cable type.

5. SELECTING THE MOUNTING POSITION

Decide the mounting position with the customer as follows:

5.1. Indoor unit

- (1) Install the indoor unit level on a strong wall which is not subject to vibration.
- (2) The inlet and outlet ports should not be obstructed: the air should be able to blow all over the room.
- (3) Install the unit a dedicated electrical branch circuit.
- (4) Do not install the unit where it will be exposed to direct sunlight.
- (5) Install the unit where connection to the outdoor unit or branch box is easy.
- (6) Install the unit where the drain pipe can be easily installed.
- (7) Take servicing, etc. into consideration and leave the spaces shown in "6.1. Installation dimensions". Also install the unit where the filter can be removed.

Correct initial installation location is important because it is difficult to move unit after it is installed.

⚠ WARNING

Select installation locations that can properly support the weight of the indoor. Install the units securely so that they do not topple or fall.

⚠ CAUTION

Do not install the unit in the following areas:

- Area with high salt content, such as at the seaside. It will deteriorate metal parts, causing the parts to fail or the unit to leak water.
- Area filled with mineral oil or containing a large amount of splashed oil or steam, such as a kitchen. It will deteriorate plastic parts, causing the parts to fail or the unit to leak water.
- Area that generates substances that adversely affect the equipment, such as sulfuric gas, chlorine gas, acid, or alkali. It will cause the copper pipes and brazed joints to corrode, which can cause refrigerant leakage.
- Area that can cause combustible gas to leak, contains suspended carbon fibers or flammable dust, or volatile inflammables such as paint thinner or gasoline.
- If gas leaks and settles around the unit, it can cause a fire.
- Area where animals may urinate on the unit or ammonia may be generated.

Do not use the unit for special purposes, such as storing food, raising animals, growing plants, or preserving precision devices or art objects. It can degrade the quality of the preserved or stored objects.

Do not install where there is the danger of combustible gas leakage.

Do not install the unit near a source of heat, steam, or flammable gas.

Install the unit where drainage does not cause any trouble.

Install the indoor unit, outdoor unit, branch box, power supply cable, transmission cable, and remote control cable at least 1 m away from a television or radio receivers. The purpose of this is to prevent TV reception interference or radio noise. (Even if they are installed more than 1 m apart, you could still receive noise under some signal conditions.)

If children under 10 years old may approach the unit, take preventive measures so that they cannot reach the unit.

Install the indoor unit on the wall where the height from the floors more than 1.8 m.

6. INSTALLATION WORK

6.1. Installation dimensions

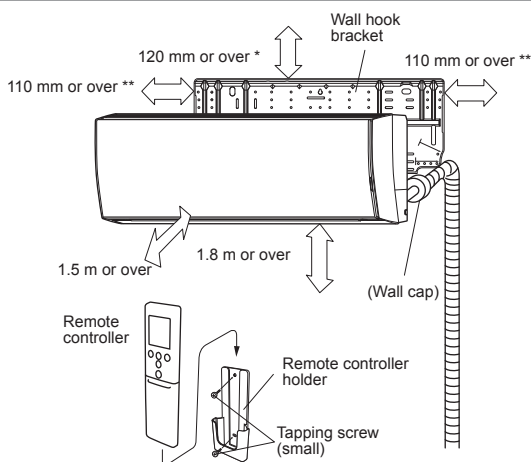

* The distance between the wall hook bracket and the ceiling should be 120 mm or more.

** The side next to the sidewall must follow the size indicated in the figure.

6.2. Indoor unit piping direction

The piping can be connected in the 6 directions indicated in the following. When the piping is connected in direction (2), (3), (4) or (5), cut along the piping groove in the side of the under cover with a hacksaw.

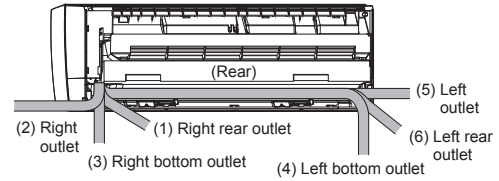

6.3. Under cover removal

- (1) Remove the screw caps and screws from the under cover (in each of 3 places).
- (2) Lift up the central part of the under cover.
- (3) Release the tabs by pressing on the side of the under cover (in 2 places on the side).
- (4) Remove the under cover while turning it.

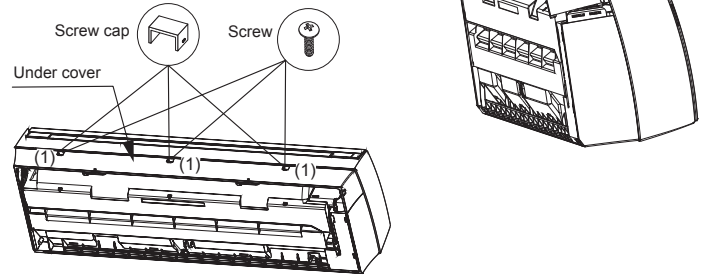

6.4. Under cover installation

- (1) Push the tabs on the side of the under cover into the base (in 2 places on the side).
- (2) Press in the top parts of the triangle markings on the under cover (in 2 places).
- (3) Attach the screws (in 3 places).
- (4) Attach the screw caps (in 3 places).

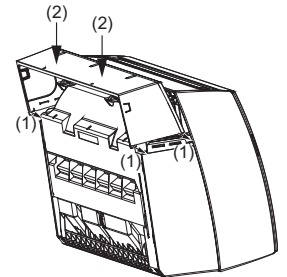

6.5. Cutting the knockout hole

Cutting the knockout hole for piping on under cover:

The piping can be connected in the 6 directions indicated in the following. When the piping is connected in direction (2), (3), (4) or (5), use a cutting tool to cut along the groove for the piping that will coming out of the under cover.

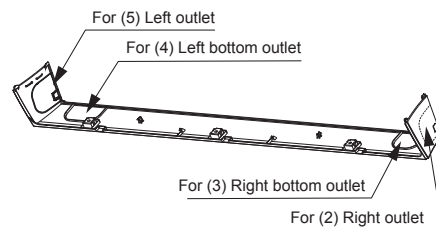

6.6. Cutting the hole in the wall for the connecting piping

- Cut a 65 mm diameter hole in the wall at the position shown in the following.
- Cut the hole so that the outside end is lower (5 to 10 mm) than the inside end.
- Always align the center of the wall hole. If misaligned, water leakage will occur.
- Cut the wall pipe to match the wall thickness, stick it into the wall cap, fasten the cap with vinyl tape, and stick the pipe through the hole.
- For left piping and right piping, cut the hole a little lower so that drain water will flow freely.

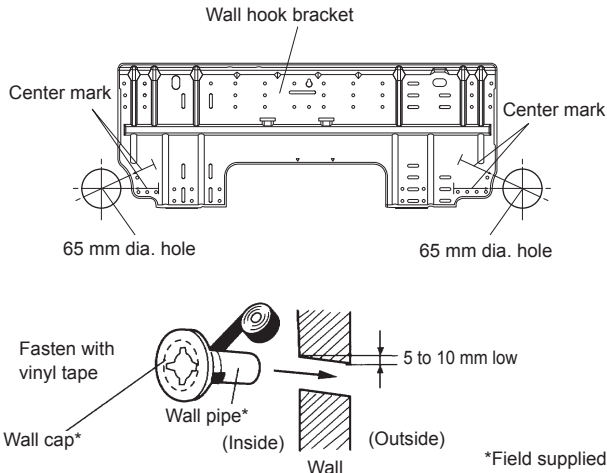

WARNING

If the wall pipe is not used, the cable interconnecting the indoor unit(s) and outdoor unit or branch box may touch metal and cause electric discharge.

6.7. Installing the wall hook bracket

- Install the wall hook bracket so that it is correctly positioned horizontally and vertically. If the wall hook bracket is tilted, water will drip to the floor.
- Install the wall hook bracket so that it is strong enough to support the weight of the unit.
 - Fasten the wall hook bracket to the wall with 5 or more screws through the holes near the outer edge of the bracket.
 - Check that there is no rattle at the wall hook bracket.

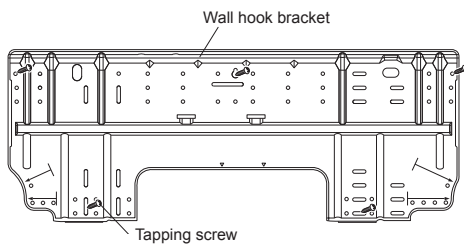

CAUTION

Install the wall hook bracket level, both horizontally and vertically.

6.8. Forming the drain hose and pipe

[Rear piping, Right piping, Bottom piping]

- Install the indoor unit piping in the direction of the wall hole and bind the drain hose and pipe together with vinyl tape.
- Install the piping so that the drain hose is at the bottom.
- Wrap the pipes of the indoor unit that are visible from the outside with decorative tape.

[For Left rear piping, Left piping]

Interchange the drain cap and the drain hose.

CAUTION

Insert drain hose and drain cap securely. Drain should slope down to avoid water leakage.

When inserting, be sure not to attach any material besides water. If any other material is attached, it will cause deterioration and water leakage.

After removing drain hose, be sure not to forget mounting drain cap.

Be sure to fix the drain hose with tape to the bottom of piping.

Prevent drain water freezing under low temperature environment.

When installing indoor unit's drain hose outdoors, necessary measure for frost protection should be taken to prevent drain water freezing.

Under low temperature environment (when outdoor temperature under 0 °C), after cooling operation is executed, water in the drain hose could be frozen. Once drain water is frozen, the drain hose will be blocked and water leakage may result at the indoor unit.

Installation method of Drain cap

Use a hexagonal wrench 4 mm at opposite side to insert the drain cap, till the drain cap contacts the tip of drain cock.

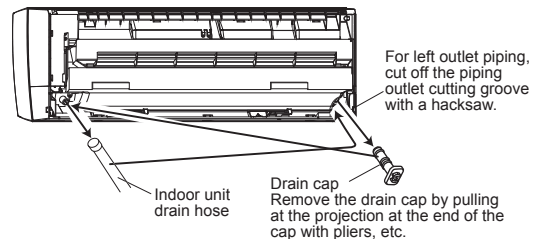
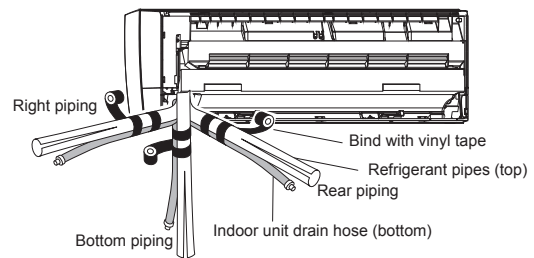
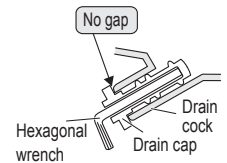

Removal method of drain hose

Remove the screw at the left of drain hose and pull out drain hose.

Installation method of drain hose

Vertically insert the drain hose toward the inside, so that the drain fixture (white) can accurately align with the screw hole around the drain cock.

After inserting and before replacing, please reinstall and fix the removed screws.

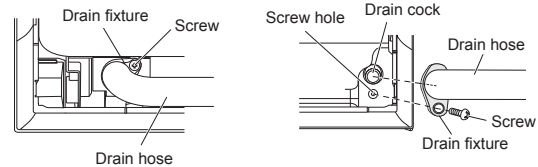

- Please hold around the joint of the drain hose during working.
- As the screw is inside, be sure to use screwdriver treated with magnet.

- For left piping and left rear piping, align the marks on the wall hook bracket and shape the connection pipe.
- Bend the connection piping at a bend radius of 70 mm or more and install no more than 35 mm from the wall.
- After passing the indoor piping and drain hose through the wall hole, hang the indoor unit on the hooks at the top and bottom of the wall hook bracket.

[Installing the indoor unit]

- Hang the indoor unit from the hooks at the top of the wall hook bracket.
- Insert the spacer, etc. between the indoor unit and the wall hook bracket and separate the bottom of the indoor unit from the wall.

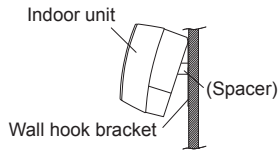

Indoor unit
Wall hook bracket
(Spacer)

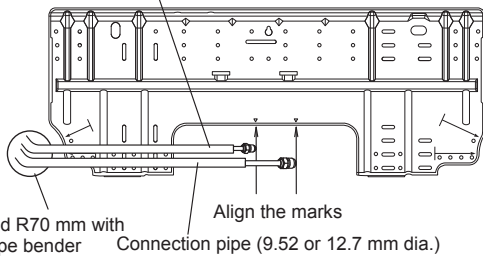

Bend R70 mm with a pipe bender
Align the marks
Connection pipe (9.52 or 12.7 mm dia.)

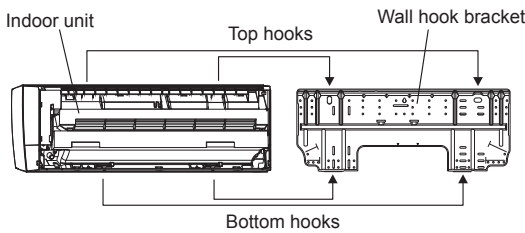

After hooking the indoor unit to the top hook, hook the fittings of the indoor unit to the 2 bottom hooks while lowering the unit and pushing it against the wall.

6.9. Flare connection (Pipe connection)

CAUTION

Tighten the flare nuts with a torque wrench using the specified tightening method. Otherwise, the flare nuts could break after a prolonged period, causing refrigerant to leak and generate hazardous gas if the refrigerant comes into contact with a flame.

6.9.1. Flaring

Use special pipe cutter and flare tool exclusive for R410A.

- (1) Cut the connection pipe to the necessary length with a pipe cutter.
- (2) Hold the pipe downward so that cuttings will not enter the pipe and remove any burrs.
- (3) Insert the flare nut (always use the flare nut attached to the indoor unit(s) and outdoor unit or branch box respectively) onto the pipe and perform the flare processing with a flare tool. Use the special R410A flare tool, or the conventional flare tool. Leakage of refrigerant may result if other flare nuts are used.
- (4) Protect the pipes by pinching them or with tape to prevent dust, dirt, or water from entering the pipes.

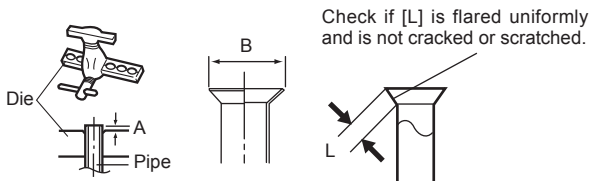

Pipe outside diameter [mm (in.)]	Dimension A [mm]	
	Flare tool for R410A, clutch type	Dimension B [mm]
6.35 (1/4)	0 to 0.5	9.1
9.52 (3/8)		13.2
12.70 (1/2)		16.6
15.88 (5/8)		19.7
19.05 (3/4)		24.0

When using conventional flare tools to flare R410A pipes, the dimension A should be approximately 0.5 mm more than indicated in the table (for flaring with R410A flare tools) to achieve the specified flaring. Use a thickness gauge to measure the dimension A.

Width across flats



Pipe outside diameter [mm (in.)]	Width across flats of Flare nut [mm]
6.35 (1/4)	17
9.52 (3/8)	22
12.70 (1/2)	26
15.88 (5/8)	29
19.05 (3/4)	36

6.9.2. Bending pipes

- If pipes are shaped by hand, be careful not to collapse them.
- Do not bend the pipes in an angle more than 90°.
- When pipes are repeatedly bend or stretched, the material will harden, making it difficult to bend or stretch them any more.
- Do not bend or stretch the pipes more than 3 times.

CAUTION

To prevent breaking of the pipe, avoid sharp bends.

If the pipe is bent repeatedly at the same place, it will break.

6.9.3. Pipe connection

CAUTION

Be sure to install the pipe against the port on the indoor unit correctly. If the centering is improper, the flare nut cannot tighten smoothly. If the flare nut is forced to turn, the threads will be damaged.

Do not remove the flare nut from the indoor unit pipe until immediately before connecting the connection pipe.

Hold the torque wrench at its grip, keeping it in the right angle with the pipe, in order to tighten the flare nut correctly.

Tighten the flare nuts with a torque wrench using the specified tightening method. Otherwise, the flare nuts could break after a prolonged period, causing refrigerant to leak and generate hazardous gas if the refrigerant comes into contact with a flame.

Connect the piping so that the control box cover can easily be removed for servicing when necessary.

In order to prevent water from leaking into the control box, make sure that the piping is well insulated.

When the flare nut is tightened properly by your hand, hold the body side coupling with a wrench, then tighten with a torque wrench. (See the table below for the flare nut tightening torques.)

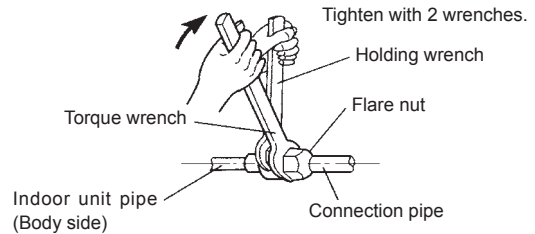

Flare nut [mm (in.)]	Tightening torque [N·m (kgf·cm)]
6.35 (1/4) dia.	16 to 18 (160 to 180)
9.52 (3/8) dia.	32 to 42 (320 to 420)
12.70 (1/2) dia.	49 to 61 (490 to 610)
15.88 (5/8) dia.	63 to 75 (630 to 750)
19.05 (3/4) dia.	90 to 110 (900 to 1,100)

7. ELECTRICAL WIRING

Cable	Cable size (mm ²)	Type	Remarks
Connection cable	1.5	Type 60245 IEC57	3Cable+Ground, 1φ 230 V

Max. Cable Length: Limit voltage drop to less than 2%. Increase cable gauge if voltage drop is 2% or more.

7.1. Wiring system diagram

⚠ WARNING

Before connecting the wires, make sure the power supply is OFF.

Every wire must be connected firmly.

No wire should be allowed to touch refrigerant tubing, the compressor or any moving part.

Loose wiring may cause the terminal to overheat or result in unit malfunction. A fire hazard may also exist. Therefore, be sure all wiring is tightly connected.

Connect wires to the matching numbers of terminals.

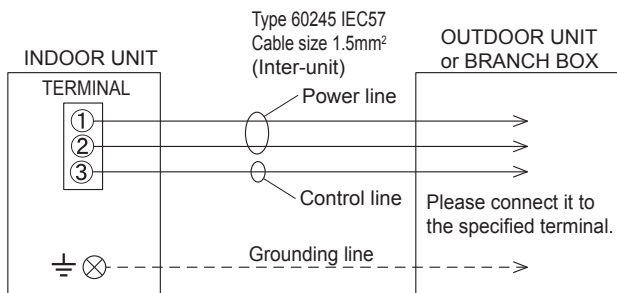

7.2. Indoor unit wiring

- By pulling the tab on each side of the intake grille with your hand toward you, open the open panel and the intake grille together until it become horizontally.
- Fix the intake grille with the grille stay.
(For the details, refer to "9.1. Intake grille removal".)
- Remove the wire cover. (Remove the 1 screw.)
- Remove the cable clamp. (Remove the 1 screw.)
- Bend the end of the connection cable as shown in the figure.
- Connect the end of the connection cable fully inserting into the terminal block.
- Fasten the connection cable with a cable clamp. (Attach the 1 screw.)

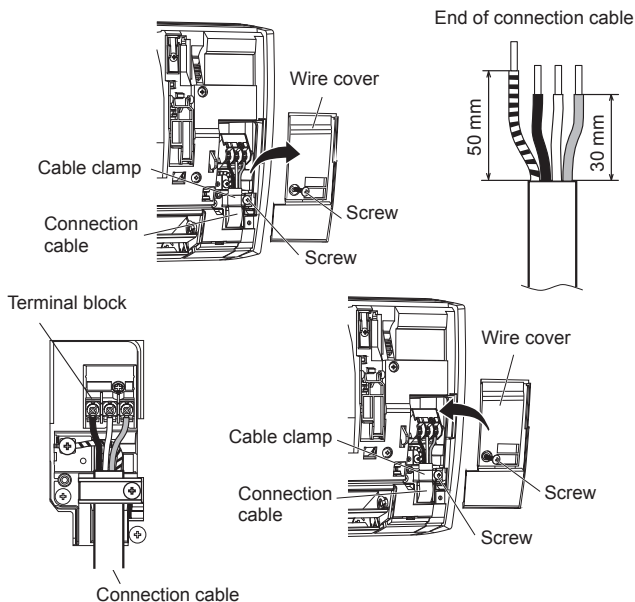

- Insert the wire cover tab into the square hole of the indoor unit and fasten with a screw.
- Return the grille stay to the original position.
(Refer to "9.2. Intake grille installation".)
- Close the open panel and the intake grille together.
(Refer to "9.2. Intake grille installation".)

7.3. How to connect wiring to the terminals

Caution when wiring cable

When stripping off the insulation of a lead wire, always use a special tool such as a wire stripper. If there is no special tool available, carefully strip the insulation with a knife etc.

- Use crimp-type terminals with insulating sleeves as shown in the figure below to connect to the terminal block.
- Securely clamp the crimp-type terminals to the wires using an appropriate tool so that the wires do not come loose.

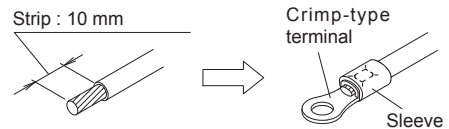

- Use the specified wires, connect them securely, and fasten them so that there is no stress placed on the terminals.
- Use an appropriate screwdriver to tighten the terminal screws. Do not use a screwdriver that is too small, otherwise, the screw heads may be damaged and prevent the screws from being properly tightened.
- Do not tighten the terminal screws too much, otherwise, the screws may break.

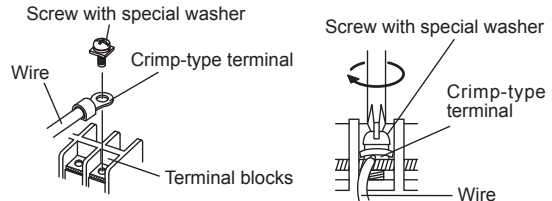

- See the table below for the terminal screw tightening torques.

Tightening torque [N·m (kgf·cm)]	
M4 screw	1.2 to 1.8 (12 to 18)

⚠ CAUTION

Attach the cable clamp firmly by holding the connection cable, and make sure that the clamp is fixed securely. Incomplete attachment of the cable clamp might cause a malfunction of the open panel.

Match the terminal block numbers and connection cable colors with those of the outdoor unit or branch box. Erroneous wiring may cause burning of the electric parts.

Connect the connection cables firmly to the terminal block. Imperfect installation may cause a fire.

Always fasten the outside covering of the connection cable with the cable clamp. (If the insulator is chafed, electric discharge may occur.)

Always connect the ground wire.

Do not use the earth screw of the indoor unit for the connection other than a specified outdoor unit or branch box.

8. FINISHING

- Insulate between pipes.
 - Insulate suction and discharge pipes separately.
 - For rear, right, and bottom piping, overlap the connection pipe heat insulation and indoor unit pipe heat insulation and bind them with vinyl tape so that there is no gap.
 - For left and left rear piping, butt the connection pipe heat insulation and indoor unit pipe heat insulation together and bind them with and vinyl tape so that there is no gap.
 - For left and left rear piping, wrap the area which accommodates the rear piping housing section with cloth tape.
 - For left and left rear piping, bind the connection cable to the top of the pipe with vinyl tape.
 - For left and left rear piping, bundle the piping and drain hose together by wrapping them with cloth tape over the range within which they fit into the rear piping housing section.
- Temporarily fasten the connection cable along the connection pipe with vinyl tape. (Wrap to about 1/3 the width of the tape from the bottom of the pipe so that water does not enter.)
- Fasten the connection pipe to the outside wall with a saddle, etc.
- Fill the gap between the outside wall pipe hole and the pipe with sealer so that rain water and wind cannot blow in.
- Fasten the drain hose to the outside wall, etc.

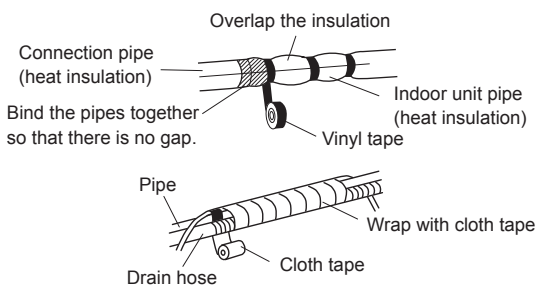
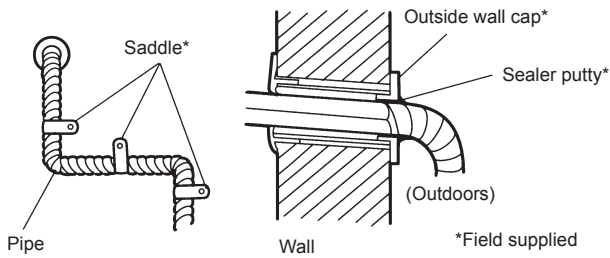

Seal A is used when the diameter of gas pipe is $\varnothing 12.70$ or more.

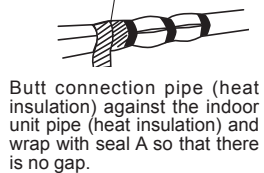

Left piping

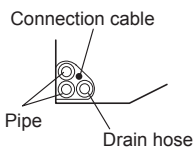

For connection from the left rear

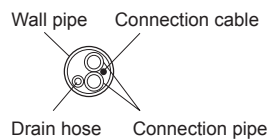

Check the following:

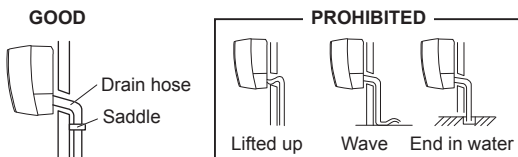

9. FRONT PANEL REMOVAL AND INSTALLATION

CAUTION

Do not open the open panel forcibly with your hands.

Opening the panel forcibly with your hands may cause a product malfunction.

(Open panel is automatically opened or closed when the power supply is turned on or off, or when the indoor unit operation is stopped.)

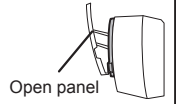

9.1. Intake grille removal

- By pulling the tab on each side of the intake grille with your hand toward you, open the open panel and the intake grille together until it becomes horizontal.

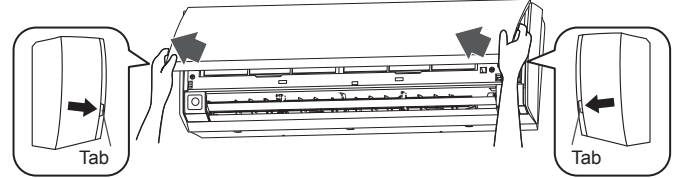

- Do not open the open panel only. Forcible opening of the open panel might cause a damage.

GOOD

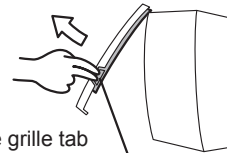

PROHIBITED

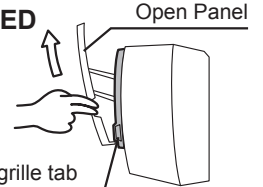

Intake grille tab

Intake grille tab

- When you open the open panel and the intake grille, do not open them forcibly to wider angle than horizontal. Forcible opening might cause a damage.

- While holding the intake grille with your hand, raise the grille stay in direction of the arrow until the claw clicks.

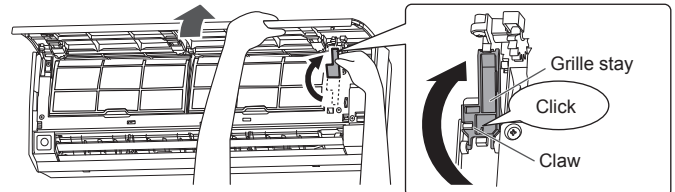

- Fix the intake grille with the grille stay.
- Remove each screw securing the grille-fall-protection clamber, both on the upper left and right of the front panel.
- Pull the open panel and the intake grille together toward you, and separate it from the unit.

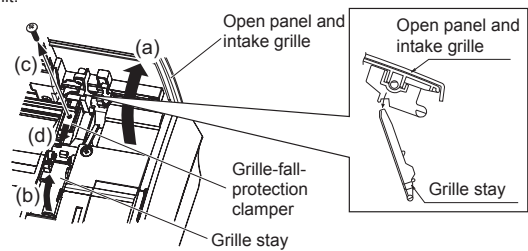

9.2. Intake grille installation

- While holding the open panel and the intake grille horizontally, insert the grille-installation shaft into the pillow block, both on the upper left and right of the front panel.

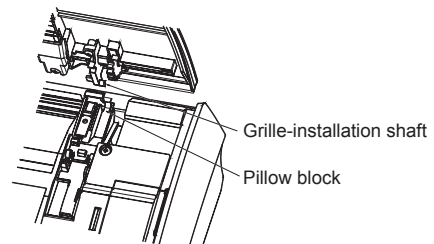

- While holding the intake grille with your hand, fix it with the grille stay.
- Secure each of the fall-protection clamber with the screw, both on the upper left and right.

- Lift the intake grille slightly to release the grille stay, and return the grille stay to the original position.

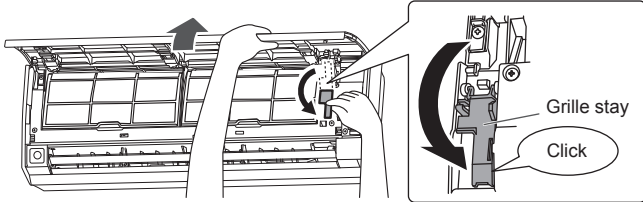

- Press point A and point C lightly until they click, then press lightly at point B.

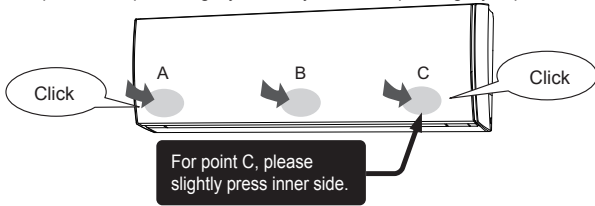

If the indoor unit operation is started without closing the intake grille firmly, the lamps flash and the indoor unit operation is stopped. When the grille is closed firmly, flashing of the lamps stop and the indoor unit starts the operation.

9.3. Front panel removal

- Remove intake grille. (Reference the intake grille removal.)
- Remove wire cover. (Remove the 1 screw.)
- Remove 4 screws.

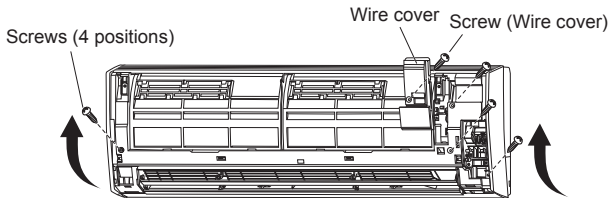

- The front panel is pulled to the front, raising the upper surface, and a front panel is removed.

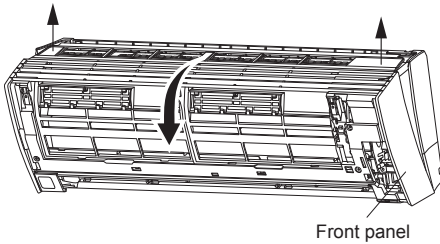

9.4. Front panel installation

- First, fit the lower part of the front panel, and insert top and bottom hooks. (2 top sides, 7 bottom sides, 2 center)

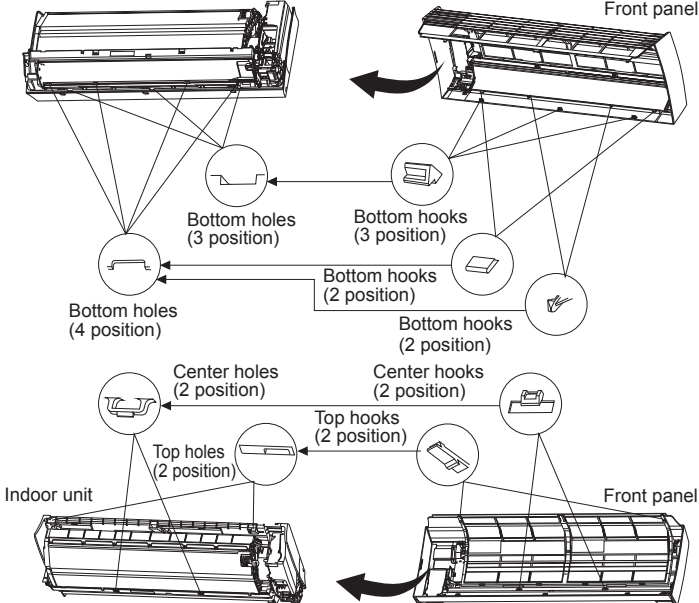

- Attach the 4 screws.
- Attach the wire cover. (Attach the 1 screw.)
- Attach the intake grille.

CAUTION

Install the Front panel and Intake grille securely. If installation is imperfect, the Front panel or Intake grille may fall off and cause injury.

10. TEST RUN

Check items

- Is operation of each button on the remote controller unit normal?
 - Does each lamp light normally?
 - Do airflow direction louvers operate normally?
 - Is the drain normal?
 - Do not have an abnormal noise and vibration during operation?
- Do not operate the air conditioner in test run for a long time.

[Operation method]

- For the operation method, refer to the operating manual.
- The outdoor unit, may not operate, depending on the room temperature. In this case, keep on pressing the MANUAL AUTO button of the indoor unit for more than 10 seconds. The OPERATION indicator lamp (green) and TIMER indicator lamp (orange) will begin to flash simultaneously during cooling test run. Then, heating test run will begin in about 3 minutes when HEAT is selected by the remote control operation. (Please follow the operating manual for remote control operation.) (When the air conditioner is running by pressing the test run button, the OPERATION indicator lamp and TIMER indicator lamp will simultaneously flash slowly.)

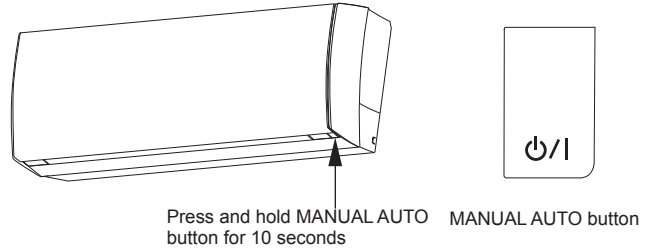

- When ending the test run, keep on pressing the MANUAL AUTO button of the indoor unit for more than 3 seconds.

[Using the wired remote controller] (Option)

For the operation method, refer to the operating manual.

- Stop the air conditioner operation.
- Press the MODE button and the FAN button simultaneously for 2 seconds or more to start the test run.

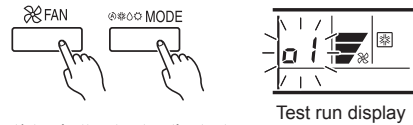

- Press the start/stop button to stop the test run.

11. REMOTE CONTROLLER INSTALLATION

CAUTION

Check that the indoor unit correctly receives the signal from the remote controller, then install the remote controller holder.

Select the remote controller holder selection site by paying careful attention to the following:

Avoid places in direct sunlight.

Select a place that will not be affected by the heat from a stove, etc.

11.1. Remote controller holder installation

- Install the remote controller a maximum distance of 6 m from the remote control signal receiver. However, when installing the remote controller, check that it operates correctly.
- Install the remote controller holder to a wall, pillar, etc. with the tapping screw.

Remote controller holder fixing

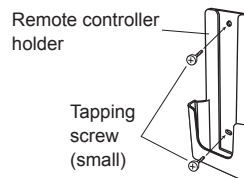

Remote controller mounting

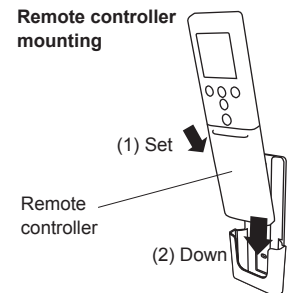

12. OPTIONAL KIT INSTALLATION (UTY-TWBXF)

This air conditioner can be connected with the following optional kits.

- Wired remote controller
- Simple remote controller
- External connect kit

BEFORE INSTALL WIRED REMOTE CONTROLLER

- When you use wired remote controller, some functions may not be used.

CAUTION

Before installing, be sure to disconnect all power supply.

Don't touch the heat exchanger.

During installing or removing operation, be sure not to have wire caught by parts or draw it hard. Or it may result troubles to the air-conditioner.

Avoid place in direct sunlight.

Select place that will not be affected by the heat from a stove, etc

Before setting up the optional kit, please confirm whether air-conditioner can receive the signal.

Do not connect the wired remote controller to the terminal for power supply.

When connecting the wired remote controller with the indoor unit, use the connecting cable (supplied with wired remote controller or simple remote controller).



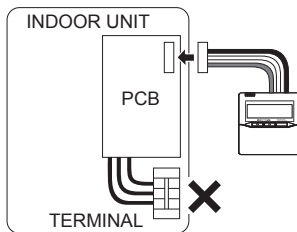

Recommended cable length of wired remote controller is 10 m. Make sure to do insulate of connecting part when extended the cable.

Do not connect power supply with the terminal.



12.1. Accessories (Communication kit)

The following installation accessories are supplied. Use them as required.

Name and Shape	Q'ty	Description
Relay control board 	1	For connecting the wired remote control unit and external connect wire.
Cable tie 	1	For fixing the wires from control box.
Relay wire 	1	For connecting the relay control board and control unit board.
Wiring label 	1	For display the additional wiring diagram.

12.2. Installation work

12.2.1. Removing intake grille and front panel

(Refer to 9.1. intake grille removal and 9.3. front panel removal)

12.2.2. Removing control cover, connector and control box

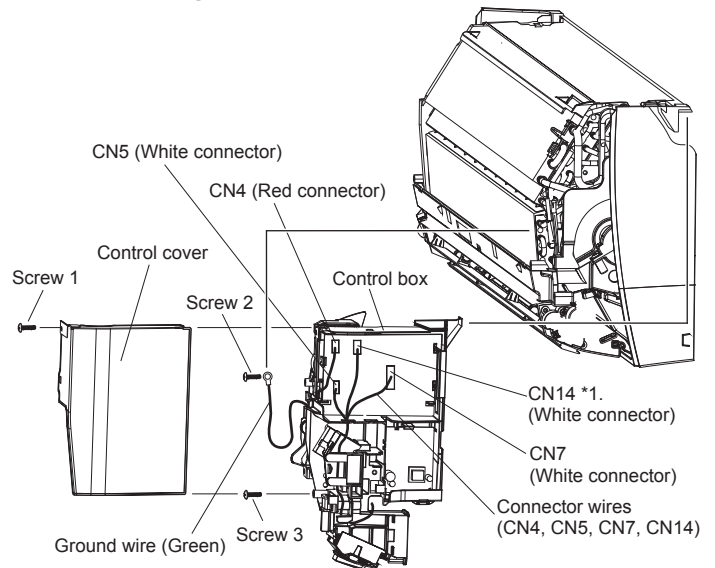

(1) Remove the screw 1 then remove the control cover.

(2) Remove the connector wires.

*1. When there is CN14 connector, pull it out.

(3) Remove the connecting cables and the screw 2 and 3, then remove the control box.

12.2.3. Installing relay control board and relay wire terminal

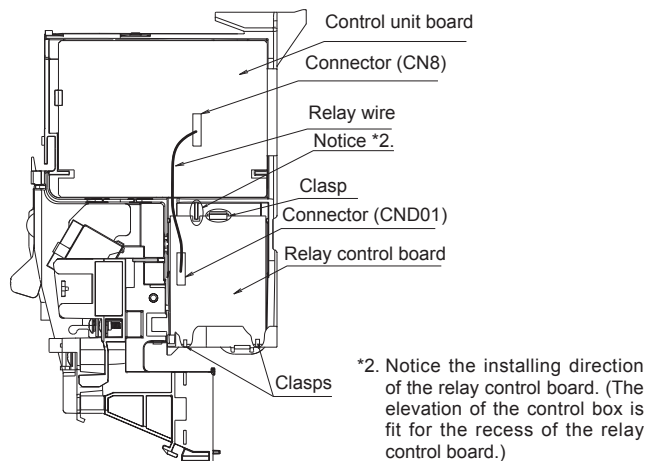

(1) Insert the relay control board toward 2 clasps.

(2) Then set the board with the clasp.

(3) Connect the relay wire terminal to the connector (CND01) on the relay control board.

(4) Connect the relay wire terminal to the connector (CN8) on the control unit board.

CAUTION

Be careful not to damage the parts on the board. Otherwise, it will cause malfunction.

12.2.4. Installing option kit

Remote controller cord modification

(1) Use a tool to cut off the terminal on the end of the remote controller cord, and then remove the insulation from the cut end of the cord.

(2) Connect the remote controller cord and connecting cord. (Supplied with wired remote controller.)

Important: Be sure to insulate the connection between the cords.

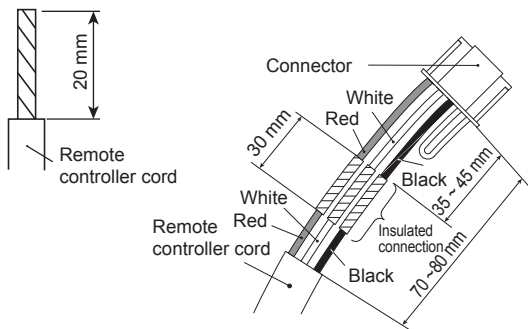

Installing the wired remote controller terminal (sold separately)

Connect the wired remote controller terminal to the connector (CNC01) on the relay control board.

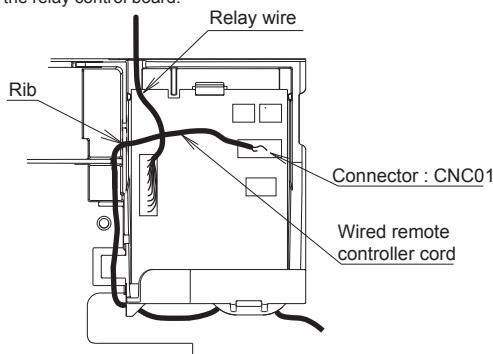

Installing the external connect kit terminal (sold separately)

Connect the wire of external input/output to the board of external connect kit.
(EXTERNAL INPUT CONNECT TO NO. CNA01
(EXTERNAL OUTPUT CONNECT TO NO. CNB01, CNB02))

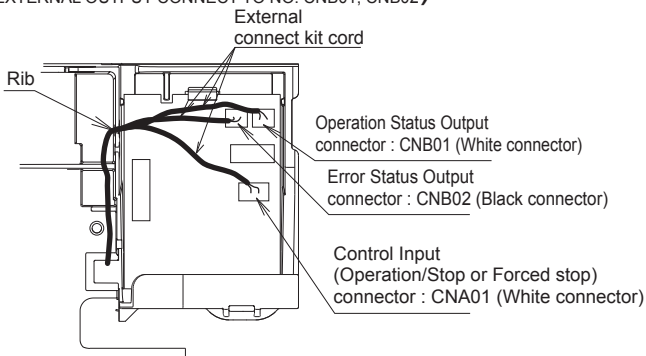

Fixing the wires

After connecting the terminals, thread the wires through the notches and clasp of the control box as circled on the figure below. Then fix the wires onto the control box with the provided cable tie.

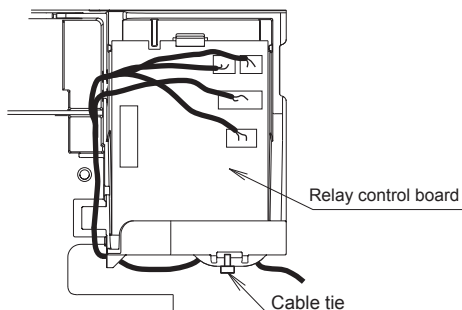

12.2.5. Installing the control box, connector and the control cover

- (1) Attach the control box to the indoor unit.
- (2) Connect the connector wires.
- (3) Attach the control cover.
- (4) Attach the 3 screws. Screw 2 is the screw which installs the ground wire.

12.2.6. Labelling

Paste the wiring label beside the label for schematic diagram inside the front panel.

12.2.7. Installing the front panel and intake grille

(Refer to 9.2. intake grille installation and 9.4. front panel installation)

13. SELECTING THE REMOTE CONTROLLER SIGNAL CODE

When two or more air conditioners are installed in a room and the remote controller is operating an air conditioner other than the one you wish to set, change the signal code of the remote controller to operate only the air conditioner you wish to set (4 selections possible). When two or more air conditioners are installed in a room, please contact your retailer to set the individual air conditioner signal codes.

Selecting the Remote Controller Signal Code

Use the following steps to select the signal code of the remote controller. (Note that the air conditioner cannot receive a signal code if the air conditioner has not been set for the signal code.)

- (1) Press the START/STOP (⏻/⏹) button until only the clock is displayed on the remote controller display.
- (2) Press the MODE button for at least 5 seconds to display the current signal code (initially set to A).
- (3) Press the SET TEMP. (▲ / ▼) buttons to change the signal code between A ↔ B ↔ C ↔ D.
Match the code on the display to the air conditioner signal code.
- (4) Press the MODE button again to return to the clock display. The signal code will be changed.

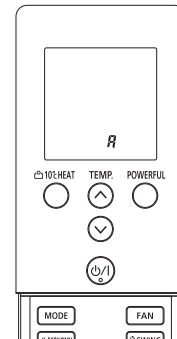

- If no buttons are pressed within 30 seconds after the signal code is displayed, the system returns to the original clock display. In this case, start again from step 1.
- The air conditioner signal code is set to A prior to shipment.

14. FUNCTION SETTING

Perform the "FUNCTION SETTING" according to the installation conditions using the remote controller.

CAUTION

Confirm whether the wiring work for outdoor unit has been finished.

Confirm that the cover for the electrical enclosure on the outdoor unit is in place.

- This procedure changes to the function settings used to control the indoor unit according to the installation conditions. Incorrect settings can cause the indoor unit to malfunction.
- After the power is turned on, perform the "FUNCTION SETTING" according to the installation conditions using the remote controller.
- The settings may be selected between the following two: Function Number or Setting Value.
- Settings will not be changed if invalid numbers or setting values are selected.
- Refer to the installation manual enclosed with the remote control unit when the wired remote control unit (option) is used.
- Adjust the signal code of the indoor unit and the signal code of the remote controller.

Entering the Function Setting Mode

While pressing the POWERFUL button and SET TEMP. (▲) simultaneously, press the RESET button to enter the function setting mode.

Selecting the Function Number and Setting Value

- (1) Press the SET TEMP. (▲ / ▼) buttons to select the function number. (Press the 10°C HEAT button to switch between the left and right digits.)
- (2) Press the POWERFUL button to proceed to setting the value. (Press the POWERFUL button again to return to the function number selection.)
- (3) Press the SET TEMP. (▲ / ▼) buttons to select the setting value. (Press the 10°C HEAT button to switch between the left and right digits.)
- (4) Press the MODE button, in the order listed to confirm the settings.
Please confirm that the beep sounds.
- (5) Next, please press START/STOP (⏻/⏹) button.
Please confirm that the beep sounds.
- (6) Press the RESET button to cancel the function setting mode.
- (7) After completing the FUNCTION SETTING, be sure to turn off the power and turn it on again.

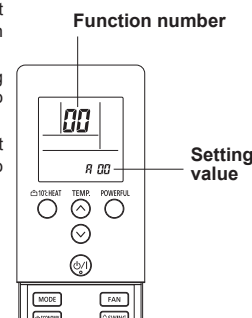

CAUTION

After turning off the power, wait 10 seconds or more before turning on it again. The Function Setting does not become active unless the power is turned off then on again.

Filter Sign

The indoor unit has a sign to inform the user that it is time to clean the filter. Select the time setting for the filter sign display interval in the table below according to the amount of dust or debris in the room. If you do not wish the filter sign to be displayed, select the setting value for "No indication".

(◆... Factory setting)

Setting Description	Function Number	Setting Value
Standard (400 hours)	11	00
Long interval (1,000 hours)		01
Short interval (200 hours)		02
◆ No indication		03

Cooling Room Temperature Correction

Depending on the installed environment, the room temperature sensor may require a correction.

The settings may be selected as shown in the table below.

(◆... Factory setting)

Setting Description	Function Number	Setting Value
◆ Standard	30	00
Slightly lower control		01
Lower control		02
Warmer control		03

Heating Room Temperature Correction

Depending on the installed environment, the room temperature sensor may require a correction.

The settings may be changed as shown in the table below.

(◆... Factory setting)

Setting Description	Function Number	Setting Value
◆ Standard	31	00
Lower control		01
Slightly warmer control		02
Warmer control		03

Auto Restart

Enable or disable automatic system restart after a power outage.

(◆... Factory setting)

Setting Description	Function Number	Setting Value
◆ Yes	40	00
No		01

* Auto restart is an emergency function such as for power failure etc. Do not start and stop the indoor unit by this function in normal operation. Be sure to operate by the control unit, or external input device.

Indoor room temperature sensor switching function

(Only for wired remote controller)

The following settings are needed when using the wired remote controller temperature sensor.

(◆... Factory setting)

Setting Description	Function Number	Setting Value
◆ No	42	00
Yes		01

* If setting value is "00" :

Room temperature is controlled by the indoor unit temperature sensor.

* If setting value is "01" :

Room temperature is controlled by either indoor unit temperature sensor or remote controller unit sensor.

Remote controller signal code

Change the indoor unit Signal Code, depending on the remote controllers.

(◆... Factory setting)

Setting Description	Function Number	Setting Value
◆ A	44	00
B		01
C		02
D		03

External input control

"Operation/Stop" mode or "Forced stop" mode can be elected.

(◆... Factory setting)

Setting Description	Function Number	Setting Value
◆ Operation/Stop mode	46	00
(Setting forbidden)		01
Forced stop mode		02

Setting record

Record any changes to the settings in the following table.

Setting Description	Setting Value
Filter sign	
Cooler room temperature correction	
Heater room temperature correction	
Auto restart	
Indoor room temperature sensor switching function	
Remote controller signal code	
External input control	

After completing the FUNCTION SETTING, be sure to turn off the power and turn it on again.

15. CUSTOMER GUIDANCE

Explain the following to the customer in accordance with the operating manual:

- (1) Starting and stopping method, operation switching, temperature adjustment, timer, air flow switching, and other remote control unit operations.
- (2) Air filter removal and cleaning, and how to use the air louvers.
- (3) Give the operating manual to the customer.

16. ERROR CODES

If you use a wireless remote controller, the lamp on the photo detector unit will output error codes by way of blinking patterns. If you use a wired remote controller, error codes will appear on the remote controller display. See the lamp blinking patterns and error codes in the table. An error display is displayed only during operation.

Error display			Wired remote controller Error code	Description
OPERATION lamp (green)	TIMER lamp (orange)	ECONOMY lamp (green)		
●(1)	●(1)	◇	11	Serial communication error
●(1)	●(2)	◇	12	Wired remote controller communication error
●(1)	●(5)	◇	15	Check run unfinished
●(2)	●(1)	◇	21	Unit number or Refrigerant circuit address setting error [Simultaneous Multi]
●(2)	●(2)	◇	22	Indoor unit capacity error
●(2)	●(3)	◇	23	Combination error

Error display			Wired remote controller Error code	Description
OPERATION lamp (green)	TIMER lamp (orange)	ECONOMY lamp (green)		
●(2)	●(4)	◇	24	• Connection unit number error (indoor slave unit) [Simultaneous Multi] • Connection unit number error (indoor unit or branch unit) [Flexible Multi]
●(2)	●(7)	◇	27	Master unit, slave unit set-up error [Simultaneous Multi]
●(3)	●(2)	◇	32	Indoor unit PCB model information error
●(3)	●(5)	◇	35	Manual auto switch error
●(4)	●(1)	◇	41	Room temp. sensor error
●(4)	●(2)	◇	42	Indoor unit Heat Ex. Middle temp. sensor error
●(5)	●(1)	◇	51	Indoor unit fan motor error
●(5)	●(3)	◇	53	Drain pump error
●(5)	●(7)	◇	57	Damper error
●(5)	●(8)	◇	58	Intake grille error
●(5)	●(15)	◇	5U	Indoor unit error
●(6)	●(2)	◇	62	Outdoor unit main PCB model information error or communication error
●(6)	●(3)	◇	63	Inverter error
●(6)	●(4)	◇	64	Active filter error, PFC circuit error
●(6)	●(5)	◇	65	Trip terminal L error
●(6)	●(10)	◇	6A	Display PCB microcomputers communication error
●(7)	●(1)	◇	71	Discharge temp. sensor error
●(7)	●(2)	◇	72	Compressor temp. sensor error
●(7)	●(3)	◇	73	Outdoor unit Heat Ex. liquid temp. sensor error
●(7)	●(4)	◇	74	Outdoor temp. sensor error
●(7)	●(5)	◇	75	Suction Gas temp. sensor error
●(7)	●(6)	◇	76	• 2-way valve temp. sensor error • 3-way valve temp. sensor error
●(7)	●(7)	◇	77	Heat sink temp. sensor error
●(8)	●(2)	◇	82	• Sub-cool Heat Ex. gas inlet temp. sensor error • Sub-cool Heat Ex. gas outlet temp. sensor error
●(8)	●(3)	◇	83	Liquid pipe temp. sensor error
●(8)	●(4)	◇	84	Current sensor error
●(8)	●(6)	◇	86	• Discharge pressure sensor error • Suction pressure sensor error • High pressure switch error
●(9)	●(4)	◇	94	Trip detection

Error display			Wired remote controller Error code	Description
OPERATION lamp (green)	TIMER lamp (orange)	ECONOMY lamp (green)		
●(9)	●(5)	◇	95	Compressor rotor position detection error
●(9)	●(7)	◇	97	Outdoor unit fan motor error
●(9)	●(9)	◇	99	4-way valve error
●(10)	●(1)	◇	A1	Discharge temp. error
●(10)	●(3)	◇	A3	Compressor temp. error
●(10)	●(4)	◇	A4	High pressure error
●(10)	●(5)	◇	A5	Low pressure error
●(13)	●(2)	◇	J2	Branch boxes error [Flexible Multi]

Display mode ● : 0.5s ON / 0.5s OFF
◇ : 0.1s ON / 0.1s OFF
() : Number of flashing

[Troubleshooting with the indoor unit display]

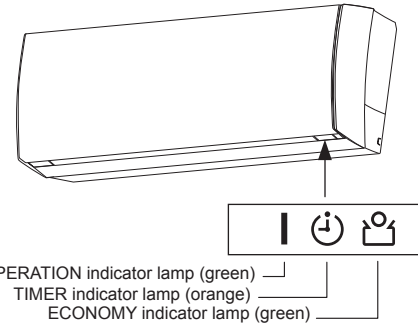

[Troubleshooting with the wired remote controller display (Option)]

If an error occurs, the following display will be shown. ("Er" will appear in the set room temperature display.)

