

AIR CONDITIONER

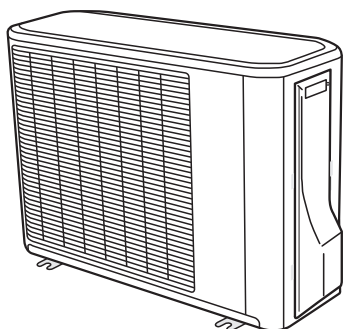

INSTALLATION MANUAL

OUTDOOR UNIT

For authorized service personnel only.

English

INSTALLATIONSANLEITUNG

AUSSENGERÄT

Nur für autorisiertes Fachpersonal.

Deutsch

MANUEL D'INSTALLATION

APPAREIL EXTÉRIEUR

Pour le personnel d'entretien autorisé uniquement.

Français

MANUAL DE INSTALACIÓN

UNIDAD EXTERIOR

Únicamente para personal de servicio autorizado.

Español

MANUALE DI INSTALLAZIONE

UNITÀ ESTERNA

A uso esclusivo del personale tecnico autorizzato.

Italiano

ΕΓΧΕΙΡΙΔΙΟ ΕΓΚΑΤΑΣΤΑΣΗΣ

ΕΞΩΤΕΡΙΚΗ ΜΟΝΑΔΑ

Μόνο για εξουσιοδοτημένο τεχνικό προσωπικό.

Ελληνικά

MANUAL DE INSTALAÇÃO

UNIDADE EXTERIOR

Apenas para pessoal de assistência autorizado.

Português

РУКОВОДСТВО ПО УСТАНОВКЕ

ВНЕШНИЙ МОДУЛЬ

Только для авторизованного обслуживающего персонала.

Русский

MONTAJ KILAVUZU

DIŞ ÜNİTE

Yalnızca yetkili servis personeli için.

Türkçe

INSTALLATION MANUAL

9316421080-02

Contents

1. SAFETY PRECAUTIONS.....	1
2. ABOUT THE UNIT.....	1
3. SELECTING THE MOUNTING POSITION.....	2
4. INSTALLATION DIAGRAM.....	3
5. INSTALLATION.....	3
6. PUMP DOWN.....	5

1. SAFETY PRECAUTIONS

- Be sure to read this manual carefully before installation.
- The warnings and precautions indicated in this manual contain important information pertaining to your safety. Be sure to observe them.
- Hand this manual, together with the operating manual, to the customer. Request the customer to keep them on hand for future use, such as for relocating or repairing the unit.

 WARNING	This mark indicates procedures which, if improperly performed, might lead to the death or serious injury of the user.
---	---

 CAUTION	This mark indicates procedures which, if improperly performed, might possibly result in personal harm to the user, or damage to property.
---	---

 WARNING
Never touch electrical components immediately after the power supply has been turned off. Electrical shock may occur. After turning off the power, always wait 10 minutes or more before touching electrical components.
Request your dealer or a professional installer to install the outdoor unit in accordance with this installation manual. An improperly installed unit can cause serious accidents such as water leakage, electric shock, or fire. If the outdoor unit is installed in disregard of the instructions in the installation manual, it will void the manufacturer's warranty.
Do not turn ON the power until all work has been completed. Turning ON the power before the work is completed can cause serious accidents such as electric shock or fire.
If refrigerant leaks while work is being carried out, ventilate the area. If the refrigerant comes in contact with a flame, it produces a toxic gas.
Installation work must be performed in accordance with national wiring standards by authorized personnel only.
Do not use this equipment with air or any other unspecified refrigerant in the refrigerant lines. Excess pressure can cause a rupture.
During installation, make sure that the refrigerant pipe is attached firmly before you run the compressor. Do not operate the compressor under the condition of refrigerant piping not attached properly with 2-way or 3-way valve open. This may cause abnormal pressure in the refrigeration cycle that leads to rupture and even injury.
When installing and relocating the air conditioner, do not mix gases other than the specified refrigerant (R410A) to enter the refrigerant cycle. If air or other gas enters the refrigerant cycle, the pressure inside the cycle will rise to an abnormally high value and cause rupture, injury, etc.
For the air conditioner to operate satisfactorily, install it as outlined in this installation manual.
Connect the indoor unit and outdoor unit with the air conditioner piping and cable available standards parts. This installation manual describes the correct connections using the installation set available from our standard parts. Also, do not use an extension cable.
Do not purge the air with refrigerants but use a vacuum pump to vacuum the installation.
There is not extra refrigerant in the outdoor unit for air purging.
Using the same vacuum pump for different refrigerants may damage the vacuum pump or the unit.
Use a clean gauge manifold, vacuum pump and charging hose for R410A exclusively.
During the pump-down operation, make sure that the compressor is turned off before you remove the refrigerant piping.
Do not remove the connection pipe while the compressor is in operation with 2 way or 3 way valve open. This may cause abnormal pressure in the refrigeration cycle that leads to rupture and even injury.

CAUTION

Read carefully all security information before use or install the air conditioner.
Do not attempt to install the air conditioner or a part of the air conditioner by yourself.
This unit must be installed by qualified personnel with a capacity certificate for handling refrigerant fluids. Refer to regulation and laws in use on installation place.
The installation must be carried out in compliance with regulations in force in the place of installation and the installation instructions of the manufacturer.
This unit is part of a set constituting an air conditioner. It must not be installed alone or with non-authorized by the manufacturer.
The unit must be correctly earthed (grounded) and the supply line must be equipped with a differential breaker in order to protect the persons.
The units are not explosion proof and therefore should not be installed in explosive atmosphere.
This unit contains no user-serviceable parts. Always consult authorized service personnel to repairs.
When moving, consult authorized service personnel for disconnection and installation of the unit.
Children should be monitored to ensure they do not play with the device.
This appliance is not intended for use by persons (including children) with reduced physical, sensory or mental capabilities, or lack of experience and knowledge, unless they have been given supervision or instruction concerning use of the appliance by a person responsible for their safety. Children should be supervised to ensure that they do not play with the appliance.
Do not touch the aluminum fins of heat exchanger built-in the indoor or outdoor unit to avoid personal injury when you install or maintain the unit.
Do not place any other electrical products or household belongings under indoor unit or outdoor unit. Dripping condensation from the unit might get them wet, and may cause damage or malfunction of your property.

2. ABOUT THE UNIT

2.1. Precautions for using R410A refrigerant

 WARNING
The basic installation work procedures are the same as conventional refrigerant (R22) models. However, pay careful attention to the following points:
Since the working pressure is 1.6 times higher than that of conventional refrigerant (R22) models, some of the piping and installation and service tools are special. (See the table below.) Especially, when replacing a conventional refrigerant (R22) model with a new refrigerant R410A model, always replace the conventional piping and flare nuts with the R410A piping and flare nuts.
Models that use refrigerant R410A have a different charging port thread diameter to prevent erroneous charging with conventional refrigerant (R22) and for safety. Therefore, check beforehand. [The charging port thread diameter for R410A is 1/2 inch.]
Be more careful that foreign matter (oil, water, etc.) does not enter the piping than with refrigerant (R22) models. Also, when storing the piping, securely seal the opening by pinching, taping, etc.
When charging the refrigerant, take into account the slight change in the composition of the gas and liquid phases. And always charge from the liquid phase where refrigerant composition is stable.

2.2. Special tools for R410A

Tool name	Contents of change
Gauge manifold	Pressure is high and cannot be measured with a conventional (R22) gauge. To prevent erroneous mixing of other refrigerants, the diameter of each port has been changed. It is recommended the gauge with seals -0.1 to 5.3 MPa (-1 to 53 bar) for high pressure. -0.1 to 3.8 MPa (-1 to 38 bar) for low pressure.
Charge hose	To increase pressure resistance, the hose material and base size were changed.
Vacuum pump	A conventional vacuum pump can be used by installing a vacuum pump adapter.
Gas leakage detector	Special gas leakage detector for HFC refrigerant R410A.

Copper pipes

It is necessary to use seamless copper pipes and it is desirable that the amount of residual oil is less than 40 mg/10 m. Do not use copper pipes having a collapsed, deformed or discolored portion (especially on the interior surface). Otherwise, the expansion valve or capillary tube may become blocked with contaminants.
As an air conditioner using R410A incurs pressure higher than when using R22, it is necessary to choose adequate materials.
Thicknesses of copper pipes used with R410A are as shown in Table1. Never use copper pipes thinner than 0.8 mm even when it is available on the market.

Thicknesses of Annealed Copper Pipes

Nominal diameter	Outer diameter	Thickness	Maximum length	Maximum height (between indoor and outdoor)
1/4 in	6.35 mm	0.8 mm	20 m (66 ft)	15 m (49 ft)
1/2 in	12.70 mm	0.8 mm		

⚠ WARNING

To install a unit that uses R410A refrigerant, use dedicated tools and piping materials that have been manufactured specifically for R410A use. Because the pressure of R410A refrigerant is approximately 1.6 times higher than R22, failure to use dedicated piping material or improper installation can cause rupture or injury. Furthermore, it can cause serious accidents such as water leakage, electric shock, or fire.

2.3. Power

⚠ WARNING

Always use a special branch circuit and install a special receptacle to supply power to the room air conditioner.

Use a circuit breaker and receptacle matched to the capacity of the air conditioner.

Install a leakage circuit breaker in accordance with the related laws and regulations and electric company standards.

The circuit breaker is installed in the permanent wiring. Always use a circuit that can trip all the poles of the wiring and has an isolation distance of at least 3 mm between the contacts of each pole.

⚠ CAUTION

The power source capacity must be the sum of the air conditioner current and the current of other electrical appliances. When the current contracted capacity is insufficient, change the contracted capacity.

When the voltage is low and the air conditioner is difficult to start, contact the power company the voltage raised.

2.4. Electric requirement

⚠ CAUTION

Be sure to install a breaker of the specified capacity.

Regulation of cables and breaker differs from each locality, refer in accordance with local rules.

Voltage rating	1 ø 230 V (50 Hz)
Operating range	198-264 V

Cable	Cable size [mm ²] ^{*1}		Type	Remarks
Power supply cable	MAX.	2.5	Type 60245 IEC57	2cable + Earth (Ground), 1ø230V
	MIN.	1.5		
Connection cable	MAX.	2.5	Type 60245 IEC57	3cable + Earth (Ground), 1ø230V
	MIN.	1.5		

^{*1} Selected sample: Select the correct cable type and size according to the country or region's regulations.
Max. wire length: Set a length so that the voltage drop is less than 2%. Increase the wire diameter when the wire length is long.

Breaker	Specification ^{*2}
Circuit breaker (over current)	Current : 20 (A)
Earth leakage breaker	Leakage current : 30mA 0.1sec or less ^{*3}

^{*2} Select the appropriate breaker of the described specification according to the national or regional standards.

^{*3} Select the breaker that enough load current can pass through it.

- Before starting work check that power is not being supplied to all poles of the indoor unit and outdoor unit.
- Install all electrical works in accordance to the national standard.
- Install the disconnect device with a contact gap of at least 3 mm in all poles nearby the units. (Both indoor unit and outdoor unit)
- Install the circuit breaker nearby the units.

2.5. Additional charge

Refrigerant suitable for a piping length of 15 m is charged in the outdoor unit at the factory. When the piping is longer than 15 m, additional charging is necessary.

Between 15 m and 20 m, when using a connection pipe other than that in the table, charge additional refrigerant with 20 g/1 m as the criteria.

For the additional amount, see the table below.

Pipe length	15 m	20 m	Rate
Additional refrigerant	None	+100 g	20 g/m

⚠ CAUTION

When adding refrigerant, add the refrigerant from the charging port at the completion of work.

The maximum length of the piping is 20 m. If the units are further apart than this, correct operation can not be guaranteed.

2.6. Accessories

The following installation accessories are supplied.

Use them as required.

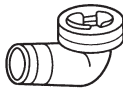
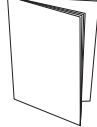
Drain pipe 	1	Installation manual 	1
--	---	--	---

One set of following parts are necessary installation of this product.

Name
Connection pipe assembly
Connection cable
Wall pipe
Decorative tape
Vinyl tape
Wall cap
Saddle
Drain hose
Tapping screws
Sealant

3. SELECTING THE MOUNTING POSITION

- Decide the mounting position with the customer as follows.
- Do not set to a place where there is oily smoke, oil is used in the factory, the unit can contact sea breeze, sulfide gases will be generated in the hot spring area, corrosive gases will be generated, animal may urine on the unit and ammonia will be generated and a dusty place.

3.1. Outdoor unit

- (1) If possible, do not install the unit where it will be exposed to direct sunlight. (If necessary, install a blind that does not interfere with the air flow.)
- (2) Do not install the unit where a strong wind blows or where it is very dusty.
- (3) Do not install the unit where people pass.
- (4) Take your neighbors into consideration so that they are not disturbed by air blowing into their windows or by noise.
- (5) Provide the space shown in figure so that the airflow is not blocked. Also for efficient operation, leave open three of the four directions front, rear, and both sides.
- (6) Install the unit where keep away more than 3 m from the antenna of TV set and Radio.
- (7) Outdoor unit should be set to a place where both drainage and itself will not be affected when heating.

⚠ WARNING

Install at a place that can withstand the weight of the outdoor units and install positively so that the units will not topple or fall.

⚠ CAUTION

Do not install where there is the danger of combustible gas leakage.

Do not install near heat sources.

If children under 10 years old may approach the unit, take preventive measures so that they cannot reach the unit.

4. INSTALLATION DIAGRAM

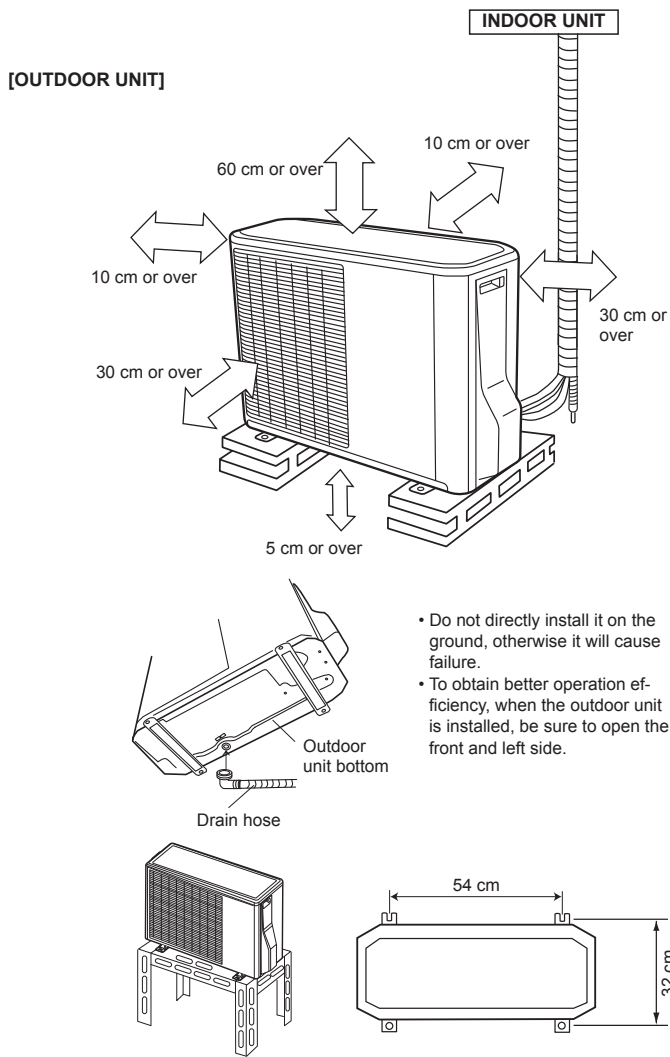

CAUTION

When the outdoor temperature is 0 °C or less, do not use the accessory drain pipe and drain cap. If the drain pipe and drain cap are used, the drain water in the pipe may freeze in extreme cold weather. (Reverse cycle model only)

In the area with heavy snowfall, if the intake and outlet of outdoor unit is blocked with snow, it might become difficult to get warm and it is likely to cause of the breakdown. Please construct a canopy and a pedestal or place the unit on a high stand (local configured).

5. INSTALLATION

5.1. Outdoor unit installation

- Set the unit on a strong stand such as thing made of concrete blocks to minimize shock and vibration.
- Do not set the unit directly on the ground because it will cause trouble.

WARNING

Install the unit where it will not be tilted by more than 5°.

When installing the outdoor unit where it may exposed to strong wind, fasten it securely.

5.2. Connector cover remove

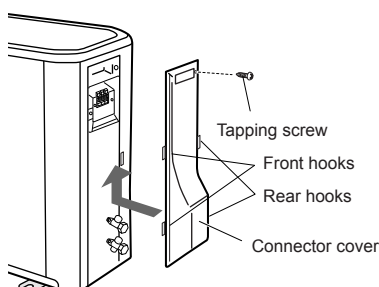

Connector cover removal

- Remove the tapping screw.

Installing the connector cover

- After inserting the four hooks, then slide the cover.
- Tighten the tapping screw.

5.3. Outdoor unit wiring

- Remove the outdoor unit connector cover.
- Bend the end of the cable as shown in the figure.
- Connect the end of the connection cable fully into the terminal block.
- Fasten the sheath with a cable clamp.
- Install the connector cover.

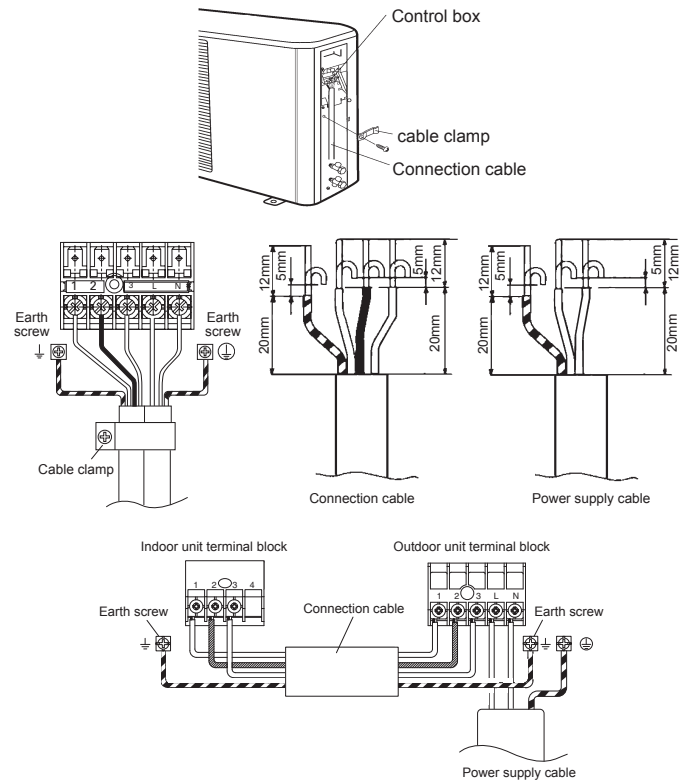

Connection cable wiring

Run the connection cable to the rear of the outdoor unit within the (A) range of the arrows shown in the figure. (The connector cover becomes difficult to install.)

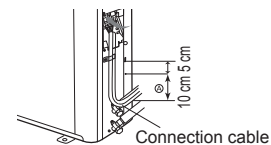

How to fixed connection cable and power supply cable at the cable clamp

After passing the connection cable and power supply cable through the insulation tube, fasten it with the cable clamp.

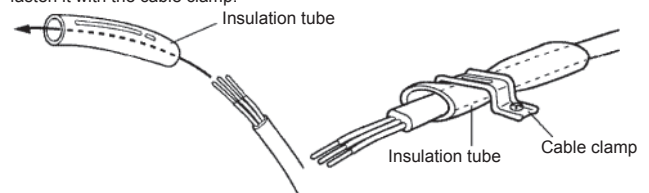

Use VW-1, 1.0 mm thick, PVC tube as the insulation tube.

5.4. HOW TO CONNECT THE WIRE TO THE TERMINALS

- Use crimp-type terminals with insulating sleeves as shown in the figure below to connect to the terminal block.
- Securely crimp the crimp-type terminals to the wires using an appropriate tool so that the wires do not come loose.
- Use the specified wires, connect them securely, and fasten them so that there is no stress placed on the terminals.
- Use an appropriate screwdriver to tighten the terminal screws. Do not use a screwdriver that is too small, otherwise, the screw heads may be damaged and prevent the screws from being properly tightened.
- Do not tighten the terminal screws too much, otherwise, the screws may break.
- See the table below for the terminal screw tightening torques.

Tightening torque

Screw Size	Tightening Torque
M4 screw	1.2 to 1.8 N · m (12 to 18 kgf · cm)
M5 screw	2.0 to 3.0 N · m (20 to 30 kgf · cm)

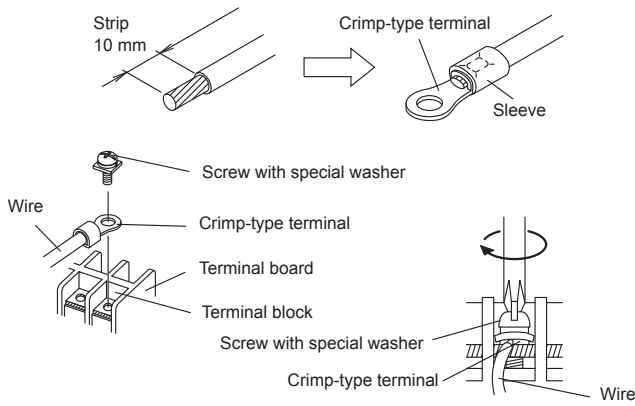

CAUTION

Match the terminal block numbers and connection cable colors with those of the indoor unit. Erroneous wiring may cause burning of the electric parts.

Connect the connection cables firmly to the terminal block. Imperfect installation may cause a fire.

Always fasten the outside covering of the connection cable with the cable clamp. (If the insulator is chafed, electric leakage may occur.)

Securely earth the power cable plug.

Do not use the earth screw for an external connector. Only use for interconnection between two units.

5.5. Connecting the piping

CONNECTION

- Install the outdoor unit wall cap (supplied with the optional installation set or procured at the site) to the wall pipe.
- Connect the outdoor unit and indoor unit piping.
- After matching the center of the flare surface and tightening the nut hand tight, tighten the nut to the specified tightening torque with a torque wrench. (Table 1)

FLARING

- Cut the connection pipe to the necessary length with a pipe cutter.
- Hold the pipe downward so that cuttings will not enter the pipe and remove the burrs.
- Insert the flare nut onto the pipe and flare the pipe with a flaring tool.

Insert the flare nut (always use the flare nut attached to the indoor and outdoor units respectively) onto the pipe and perform the flare processing with a flare tool. Use the special R410A flare tool, or the conventional (for R22) flare tool. When using the conventional flare tool, always use an allowance adjustment gauge and secure the A dimension shown in table 2.

Check if [L] is flared uniformly and is not cracked or scratched.

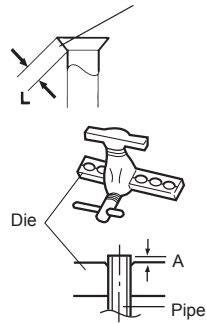

BENDING PIPES

- When bending the pipe, be careful not to crush it.
- To prevent breaking of the pipe, avoid sharp bends. Bend the pipe with a radius of curvature of 70 mm or over.
- If the copper pipe is bend the pipe or pulled to often, it will become stiff. Do not bend the pipes more than three times at one place.

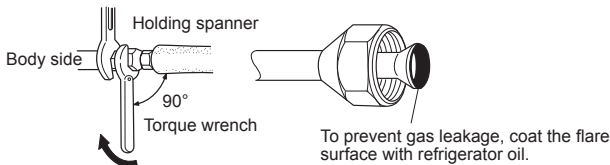

Table 1 Flare nut tightening torque

Flare nut	Diameter (mm) x Torque (N · m)
6.35 mm dia.	17 x 16 ~ 18
12.7 mm dia.	26 x 49 ~ 61

Table 2 Pipe outside diameter

Pipe outside diameter	A (mm)		
	Flare tool for R410A, clutch type	Conventional (R22) Flaring tool	
		Clutch type	Wing nut type
ø 6.35 mm (1/4")	0 to 0.5	1.0 to 1.5	1.5 to 2.0
ø 12.7 mm (1/2")	0 to 0.5	1.0 to 1.5	1.5 to 2.0

CAUTION

Fasten a flare nut with a torque wrench as instructed in this manual. If fastened too tight, the flare nut may be broken after a long period of time and cause a leakage of refrigerant.

5.6. Air purge

Always use a vacuum pump to purge the air.

Refrigerant for purging the air is not charged in the outdoor unit at the factory.

Close the high pressure side valve of the gauge manifold fully and do not operate it during the following work.

CAUTION

Refrigerant must not be discharged into atmosphere.

After connecting the piping, check the joints for gas leakage with gas leak detector.

- Check if the piping connections are secure.
- Check that the stems of 2-way valve and 3-way valve are closed fully.
- Connect the gauge manifold charge hose to the charging port of the 3-way valve (side with the projection for pushing in the valve core).
- Open the low pressure side valve of the gauge manifold fully.
- Operate the vacuum pump and start pump down.
- Slowly loosen the flare nut of the 3-way valve and check if air enters, then retighten the flare nut. (When the flare nut is loosened the operating sound of the vacuum pump changes and the reading of the compound pressure gauge goes from minus to zero.)
- Pump down the system for at least 15 minutes, then check if the compound pressure gauge reads -0.1 MPa (-76 cmHg, -1 bar).
- At the end of pump down, close the low pressure side valve of the gauge manifold fully and stop the vacuum pump.
- Slowly loosen the valve stem of the 3-way valve. When the compound pressure gauge reading reaches 0.1-0.2 MPa, retighten the valve stem and disconnect the charge hose from the 3-way valve charging port. (If the stem of the 3-way valve is opened fully before the charge hose is disconnected, it may be difficult to disconnect the charge hose.)
- Fully open the valve stems of the 2-way valve and 3-way valve using a hexagon wrench. (After the valve stem begins to turn, turn it with a torque of less than 2.9 N · m (30 kgf · cm) until it stops turning.)
- Firmly tighten the 2-way valve and 3-way valve blank cap and the charging port cap.

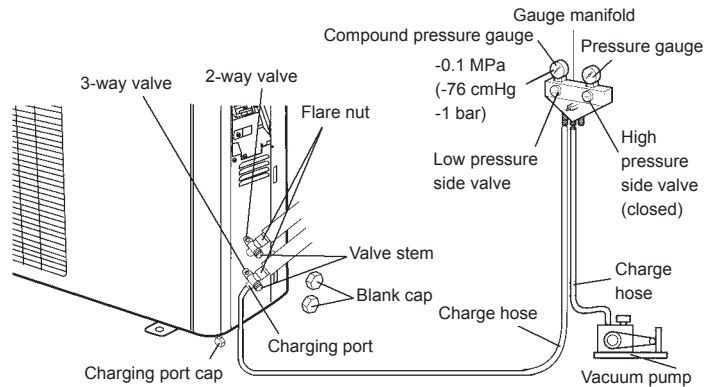

	Tightening torque
Blank cap (2-way valve)	20.0 to 25.0 N · m (200 to 250 kgf · cm)
Blank cap (3-way valve)	28.0 to 32.0 N · m (280 to 320 kgf · cm)
Charging port cap	12.5 to 16.0 N · m (125 to 160 kgf · cm)

5.7. TEST RUN

- Perform test operation and check items below.
- For the test operation method, refer to the operating manual.
- The outdoor unit, may not operate, depending on the room temperature. In this case, press the TEST RUN button on the remote controller while the air conditioner is running. (Point the transmitter section of the remote controller toward the air conditioner and press the TEST RUN button with the tip of a ball-point pen, etc.)
- To end test operation, press the remote controller START/STOP button. (When the air conditioner is run by pressing the TEST RUN button, the OPERATION indicator lamp and TIMER indicator lamp will simultaneously flash slowly.)

OUTDOOR UNIT

- Is there any abnormal noise and vibration during Transmitter section operation?
- Will noise, wind, or drain water from the unit disturb the neighbors?
- Is there any gas leakage?



5.8. CUSTOMER GUIDANCE

Explain the followings to the customer in accordance with the operating manual:

- (1) Starting and stopping method, operation switching, temperature adjustment, timer, airflow switching, and other remote controller operations.
- (2) Air filter removal and cleaning, and how to use the airflow direction louvers.
- (3) Give the operating and installation manuals to the customer.

6. PUMP DOWN

6.1. Pump down

PUMP DOWN OPERATION (FORCED COOLING OPERATION)

To avoid discharging refrigerant into the atmosphere at the time of relocation or disposal, recover refrigerant by doing the cooling operation or forced cooling operation according to the following procedure. (When the cooling operation cannot start in winter, and so on, start the forced cooling operation.)

- (1) Do the air purging of the charge hose by connecting the charging hose of gauge manifold to the charging port of 3-way valve and opening the low-pressure valve slightly.
- (2) Close the valve stem of 2-way valve completely.
- (3) Start the cooling operation or following forced cooling operation. Keep on pressing the MANUAL AUTO button of the indoor unit for more than 10 seconds. The operation indicator lamp and timer indicator lamp will begin to flash simultaneously during test run. (The forced cooling operation cannot start if the MANUAL AUTO button is not kept on pressing for more than 10 seconds.)
- (4) Close the valve stem of 3-way valve when the reading on the compound pressure gage becomes 0.05~0 Mpa(0.5~0 kg/cm²).
- (5) Stop the operation.
 - Press the START/STOP button of the remote control unit to stop the operation.
 - Press the MANUAL AUTO button when stopping the operation from indoor unit side. (It is not necessary to press on keeping for more than 10 seconds.)