

# AIR CONDITIONER OUTDOOR UNIT

# INSTALLATION MANUAL

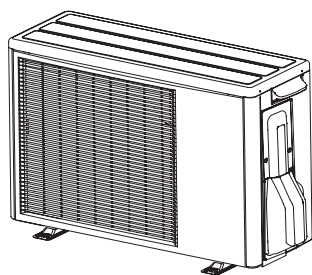

## INSTALLATION MANUAL

For authorized service personnel only.

English

## INSTALLATIONSANLEITUNG

Nur für autorisiertes Personal.

Deutsch

## MANUEL D'INSTALLATION

Pour le personnel agréé uniquement.

Français

## MANUAL DE INSTALACIÓN

Solo para personal autorizado.

Español

## MANUALE D'INSTALLAZIONE

Ad uso esclusivo del personale autorizzato.

Italiano

## ΕΓΧΕΙΡΙΔΙΟ ΕΓΚΑΤΑΣΤΑΣΗΣ

Για εξουσιοδοτημένο προσωπικό σέρβις.

Ελληνικά

## MANUAL DE INSTALAÇÃO

Apenas para técnicos autorizados.

Português

## РУКОВОДСТВО ПО УСТАНОВКЕ

Для уполномоченного персонала.

Русский

## KURULUM KILAVUZU

Yetkili servis personeli içindir.

Türkçe

**Contents**

1. SAFETY PRECAUTIONS..... 1  
 2. ABOUT THE UNIT..... 1  
 3. SELECTING THE MOUNTING POSITION..... 2  
 4. INSTALLATION DIAGRAM..... 2  
 5. INSTALLATION..... 2  
 6. PUMP DOWN..... 4

**1. SAFETY PRECAUTIONS**

**1.1. For authorized service personnel only**

 <b>WARNING</b>	This mark indicates procedures which, if improperly performed, might lead to the death or serious injury of the user.
For the room air conditioner to operate satisfactorily, install it as outlined in this installation manual.	
Connect the indoor unit and outdoor unit with the air conditioner piping and cords available standards parts. This installation manual describes the correct connections using the standard accessories and the parts specified in this installation manual.	
Have installation work done by authorized service personnel only.	
Do not use an extension cord.	
Do not turn on the power until all installation work is complete.	

 <b>CAUTION</b>	This mark indicates procedures which, if improperly performed, might possibly result in personal harm to the user, or damage to property.
When installing pipes shorter than 3 m, sound of the outdoor unit will be transferred to the indoor unit, which will cause large operating sound or some abnormal sound.	
This installation manual describes how to install the outdoor unit only. To install the indoor unit, refer to the installation manual included with the indoor unit.	

- Be careful not to scratch the air conditioner when handling it.
- After installation, explain correct operation to the customer, using the operating manual.
- Let the customer keep this installation manual because it is used when the air conditioner is serviced or moved.
- The maximum length of the piping is 20 m. The maximum height difference of the piping is 15 m, if the units are further apart than these, correct operation can not be guaranteed.

**2. ABOUT THE UNIT**

**2.1. Precautions for using R410A refrigerant**

The basic installation work procedures are the same as conventional refrigerant (R22) models. However, pay careful attention to the following points:
Since the working pressure is 1.6 times higher than that of conventional refrigerant (R22) models, some of the piping and installation and service tools are special. (See the table below.) Especially, when replacing a conventional refrigerant (R22) model with a new refrigerant R410A model, always replace the conventional piping and flare nuts with the R410A piping and flare nuts.
Models that use refrigerant R410A have a different charging port thread diameter to prevent erroneous charging with conventional refrigerant (R22) and for safety. Therefore, check beforehand. [The charging port thread diameter for R410A is 1/2 inch.]

Be more careful that foreign matter (oil, water, etc.) does not enter the piping than with refrigerant (R22) models. Also, when storing the piping, securely seal the opening by pinching, taping, etc.

When charging the refrigerant, take into account the slight change in the composition of the gas and liquid phases. And always charge from the liquid phase where refrigerant composition is stable.

**2.2. Special tools for R410A**

Tool name	Contents of change
<b>Gauge manifold</b>	Pressure is high and cannot be measured with a conventional (R22) gauge. To prevent erroneous mixing of other refrigerants, the diameter of each port has been changed. It is recommended the gauge with seals -0.1 to 5.3 MPa (-1 to 53 bar) for high pressure. -0.1 to 3.8 MPa (-1 to 38 bar) for low pressure.
<b>Charge hose</b>	To increase pressure resistance, the hose material and base size were changed.
<b>Vacuum pump</b>	A conventional vacuum pump can be used by installing a vacuum pump adapter.
<b>Gas leakage detector</b>	Special gas leakage detector for HFC refrigerant R410A.

**Copper pipes**

It is necessary to use seamless copper pipes and it is desirable that the amount of residual oil is less than 40 mg/10 m. Do not use copper pipes having a collapsed, deformed or discolored portion (especially on the interior surface). Otherwise, the expansion valve or capillary tube may become blocked with contaminants.

As an air conditioner using R410A incurs pressure higher than when using R22, it is necessary to choose adequate materials.

Thicknesses of copper pipes used with R410A are as shown in Table1. Never use copper pipes thinner than 0.8mm even when it is available on the market.

**Thicknesses of Annealed Copper Pipes**

		Thickness (mm)	
Nominal diameter	Outer diameter (mm)	R410A	[ref.] R22
1/4 in.	6.35	0.80	0.80
3/8 in.	9.52	0.80	0.80
1/2 in.	12.7	0.80	0.80

 **WARNING**

**Do not use the existing (for R22) piping and flare nuts.**

If the existing materials are used, the pressure inside the refrigerant cycle will rise and cause failure, injury, etc. (Use the special R410A materials.)

**When installing and relocating the air conditioner, do not mix gases other than the specified refrigerant (R410A) to enter the refrigerant cycle.**

If air or other gas enters the refrigerant cycle, the pressure inside the cycle will rise to an abnormally high value and cause failure, injury, etc.

**2.3. Power**

- The rated voltage

230V AC 50Hz.

 **WARNING**

The rated voltage of this product is 230 V AC 50 Hz.

Before turning on the power, check if the voltage is within the 220 V -10 % to 240 V +10 % range.

Always use a special branch circuit and install a special receptacle to supply power to the room air conditioner.

Use a circuit breaker and receptacle matched to the capacity of the air conditioner.

Do not extend the power cable.

Perform wiring work in accordance with standards so that the air conditioner can be operated safely and positively.

Install a leakage circuit breaker in accordance with the related laws and regulations and electric company standards.

 **CAUTION**

The power source capacity must be the sum of the air conditioner current and the current of other electrical appliances. When the current contracted capacity is insufficient, **change the contracted capacity.**

When the voltage is low and the air conditioner is difficult to start, contact the power company the voltage raised.

## 2.4. Electric requirement

- Electric wire size and fuse capacity:

MODEL	12,000 ~ 14,000 BTU class
Power supply cord (mm <sup>2</sup> )	1.5
Connection cord (mm <sup>2</sup> )	1.5 or 1
Fuse capacity (A)	15

- Use conformed cable with Type245 IEC57.
- Install all electrical works in accordance to the national standard.
- Install the disconnect device with a contact gap of at least 3 mm in all poles nearby the units. (Both indoor unit and outdoor unit)
- Install the circuit breaker nearby the units.

## 2.5. Accessories

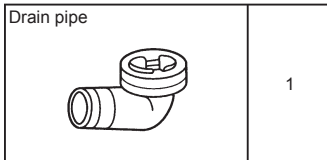

## 2.6. Additional charge

Refrigerant suitable for a piping length of 15 m is charged in the outdoor unit at the factory. When the piping is longer than 15 m, additional charging is necessary. For the additional amount, see the table below.

Pipe length	15 m	20 m	Rate
Additional refrigerant	None	+100 g	20 g/m

### CAUTION

When adding refrigerant, add the refrigerant from the charging port at the completion of work.

The maximum length of the piping is 20 m. If the units are further apart than this, correct operation can not be guaranteed.

Between 15 m and 20 m, when using a connection pipe other than that in the table, charge additional refrigerant with 20 g/1 m as the criteria.

## 3. SELECTING THE MOUNTING POSITION

- Decide the mounting position with the customer as follows:
- Do not set to a place where there is oily smoke, oil is used in the factory, the unit can contact sea breeze, sulfide gases will be generated in the hot spring area, corrosive gases will be generated, animal may urine on the unit and ammonia will be generated and a dusty place.

### 3.1. Outdoor unit

- If possible, do not install the unit where it will be exposed to direct sunlight. (If necessary, install a blind that does not interfere with the air flow.)
- Do not install the unit where a strong wind blows or where it is very dusty.
- Do not install the unit where people pass.
- Take your neighbors into consideration so that they are not disturbed by air blowing into their windows or by noise.
- Provide the space shown in figure so that the air flow is not blocked. Also for efficient operation, leave open three of the four directions front, rear, and both sides.
- Install the unit where keep away more than 3m from the antenna of TV set and Radio.
- Outdoor unit should be set to a place where both drainage and itself will not be affected when heating.

### WARNING

Install at a place that can withstand the weight of the outdoor units and install positively so that the units will not topple or fall.

### CAUTION

Do not install where there is the danger of combustible gas leakage.

Do not install near heat sources.

In places where the outdoor temperature drops to 0 °C or lower, the drain water may freeze and may stop up the drain or cause other outdoor unit trouble. Therefore take measures so that the drain water will not freeze and clog the drain.

In the area with heavy snowfall, if the intake and outlet of outdoor unit is blocked with snow, it might become difficult to get warm and it is likely to cause of the breakdown. Please construct a canopy and a pedestal or place the unit on a high stand (local configured).

If children under 10 years old may approach the unit, take preventive measures so that they cannot reach the unit.

## 4. INSTALLATION DIAGRAM

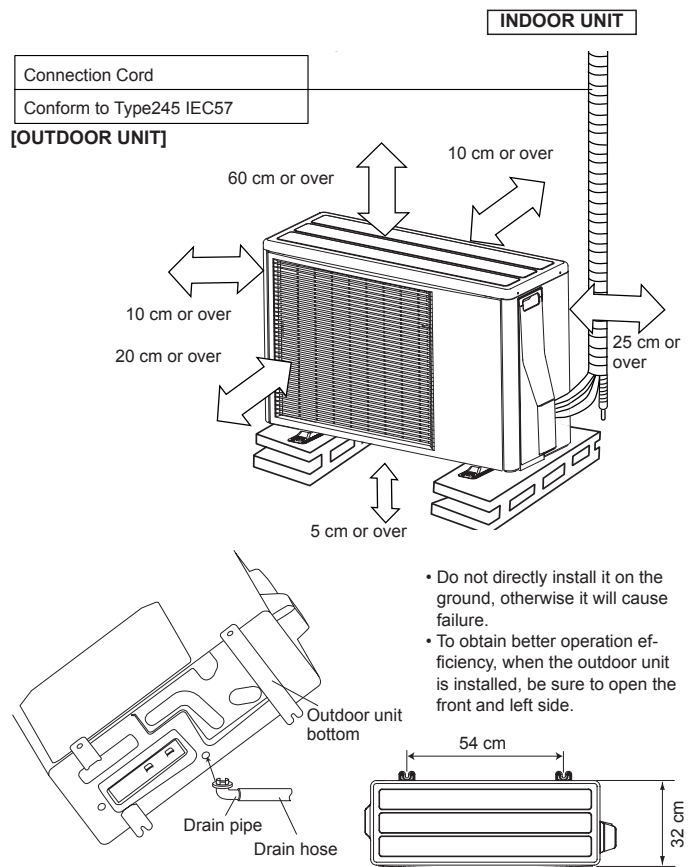

### CAUTION

When the outdoor temperature is 0 °C or less, do not use the accessory drain pipe and drain cap. If the drain pipe and drain cap are used, the drain water in the pipe may freeze in extreme cold weather. (Reverse cycle model only)

In the area with heavy snowfall, if the intake and outlet of outdoor units blocked with snow, it might become difficult to get warm and it is likely to cause of the breakdown. Please construct a canopy and a pedestal or place the unit on a high stand (local configured).

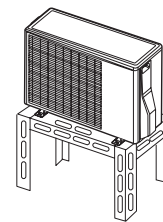

## 5. INSTALLATION

### 5.1. Outdoor unit installation

- Set the unit on a strong stand such as thing made of concrete blocks to minimize shock and vibration.
- Do not set the unit directly on the ground because it will cause trouble.

#### Switch cover A, B removal

- Remove the three tapping screws.
- Push downward the Switch cover B.
- Push upward the Switch cover A.

#### Installing the Switch cover A, B

- After inserting the three hooks of Switch cover A, then push upward, and then tighten the two tapping screws.
- After inserting the three hooks of Switch cover B, then push upward, and then tighten the one tapping screw.

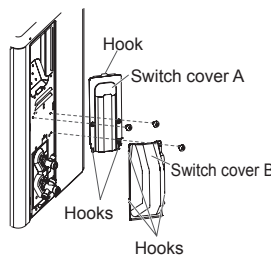

### WARNING

Install the unit where it will not be tilted by more than 5°.

When installing the outdoor unit where it may exposed to strong wind, fasten it securely.

## 5.2. Outdoor unit wiring

- Remove the outdoor unit Switch cover A, B.
- Remove the outdoor unit Cord clamp and Nylon clamp.
- Bend the end of the cord as shown in the figure.
- Connect the end of the connection cord fully into the terminal block.
- Fasten the sheath with a cord clamp.
- Fasten the sheath with a nylon clamp.
- Install the Switch cover A, B.

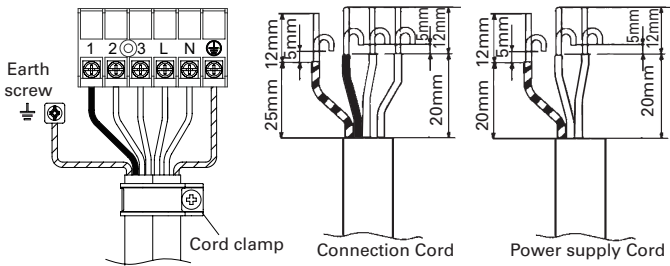
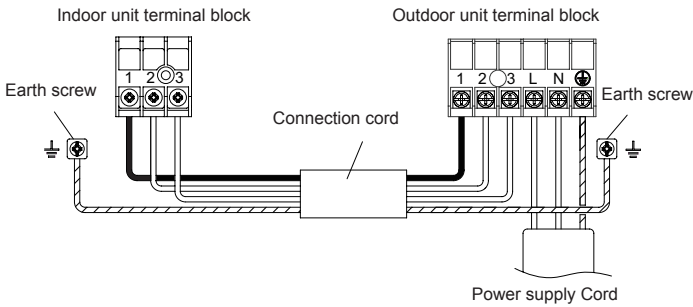
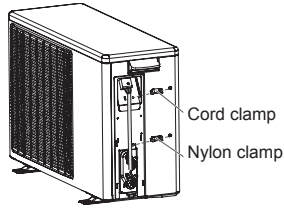

### Connection cord wiring

Run the connection cord to the rear of the outdoor unit within the (A) range of the arrows shown in the figure.

(The Switch cover B becomes difficult to install.)

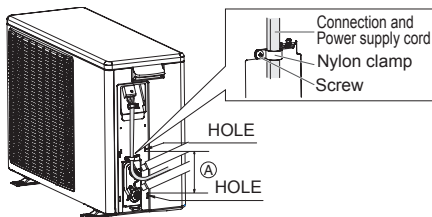

### CAUTION

Match the terminal block numbers and connection cord colors with those of the indoor unit. Erroneous wiring may cause burning of the electric parts.

Connect the connection cords firmly to the terminal block. Imperfect installation may cause a fire.

Always fasten the outside covering of the connection cord with the cord clamp. (If the insulator is chafed, electric leakage may occur.)

Securely earth the power cord.

Do not use the earth screw for an external connector. Only use for interconnection between two units.

## 5.3. Connecting the piping

### CONNECTION

- Install the outdoor unit wall cap (supplied with the optional installation set or procured at the site) to the wall pipe.

- Connect the outdoor unit and indoor unit piping.
- After matching the center of the flare surface and tightening the nut hand tight, tighten the nut to the specified tightening torque with a torque wrench. (Table 1)

Check if [L] is flared uniformly and is not cracked or scratched.

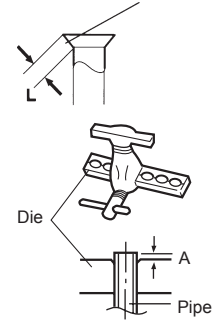

### FLARING

- Cut the connection pipe to the necessary length with a pipe cutter.
- Hold the pipe downward so that cuttings will not enter the pipe and remove the burrs.
- Insert the flare nut onto the pipe and flare the pipe with a flaring tool.

Insert the flare nut (always use the flare nut attached to the indoor and outdoor units respectively) onto the pipe and perform the flare processing with a flare tool.

Use the special R410A flare tool, or the conventional (for R22) flare tool.

When using the conventional flare tool, always use an allowance adjustment gauge and secure the A dimension shown in table 2.

### BENDING PIPES

- When bending the pipe, be careful not to crush it.
- To prevent breaking of the pipe, avoid sharp bends. Bend the pipe with a radius of curvature of 70mm or over.
- If the copper pipe is bent the pipe or pulled to often, it will become stiff. Do not bend the pipes more than three times at one place.

Tighten with two wrenches.

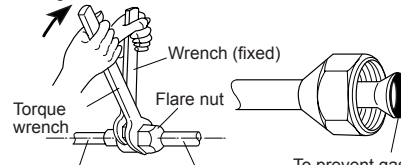

To prevent gas leakage, coat the flare surface with refrigerator oil.

Table 1 Flare nut size and tightening torque

Flare nut	Diameter (mm) × Torque (N·m)
6.35 mm dia.	17 × 16 ~ 18
9.52 mm dia.	22 × 32 ~ 42
12.7 mm dia.	26 × 49 ~ 61

Table 2 Pipe outside diameter

Pipe outside diameter	Flare tool for R410A, clutch type	A (mm)	
		Clutch type	Wing nut type
ø 6.35 mm (1/4")	0 to 0.5	1.0 to 1.5	1.5 to 2.0
ø 9.52 mm (3/8")	0 to 0.5	1.0 to 1.5	1.5 to 2.0
ø 12.7 mm (1/2")	0 to 5	1.0 to 1.5	1.5 to 2.0

### CAUTION

Fasten a flare nut with a torque wrench as instructed in this manual. If fastened too tight, the flare nut may be broken after a long period of time and cause a leakage of refrigerant.

During installation, make sure that the refrigerant pipe is attached firmly before you run the compressor. Do not operate the compressor under the condition of refrigerant piping not attached properly with 2-way or 3-way valve open. This may cause abnormal pressure in the refrigeration cycle that leads to breakage and even injury.

## 5.4. Air purge

Always use a vacuum pump to purge the air.

Refrigerant for purging the air is not charged in the outdoor unit at the factory.

Close the high pressure side valve of the gauge manifold fully and do not operate it during the following work.

### CAUTION

Refrigerant must not be discharged into atmosphere.

After connecting the piping, check the joints for gas leakage with gas leak detector.

- Check if the piping connections are secure.
- Check that the stems of 2-way valve and 3-way valve are closed fully.
- Connect the gauge manifold charge hose to the charging port of the 3-way valve (side with the projection for pushing in the valve core).
- Open the low pressure side valve of the gauge manifold fully.
- Operate the vacuum pump and start pump down.
- Slowly loosen the flare nut of the 3-way valve and check if air enters, then retighten the flare nut.  
(When the flare nut is loosened the operating sound of the vacuum pump changes and the reading of the compound pressure gauge goes from minus to zero.)
- Pump down the system for at least 15 minutes, then check if the compound pressure gauge reads -0.1 MPa (-76 cmHg, -1 bar).
- At the end of pump down, close the low pressure side gauge of the gauge manifold fully and stop the vacuum pump.
- Slowly loosen the valve stem of the 3-way valve. When the compound pressure

gauge reading reaches 0.1-0.2 MPa, retighten the valve stem and disconnect the charge hose from the 3-way valve charging port.

(If the stem of the 3-way valve is opened fully before the charge hose is disconnected, it may be difficult to disconnect the charge hose.)

- (10) Fully open the valve stems of the 2-way valve and 3-way valve using a hexagon wrench. (After the valve stem begins to turn, turn it with a torque of less than  $2.9 \text{ N} \cdot \text{m}$  ( $30 \text{ kgf} \cdot \text{cm}$ ) until it stops turning.)
- (11) Firmly tighten the 2-way valve and 3-way valve blank cap and the charging port cap.

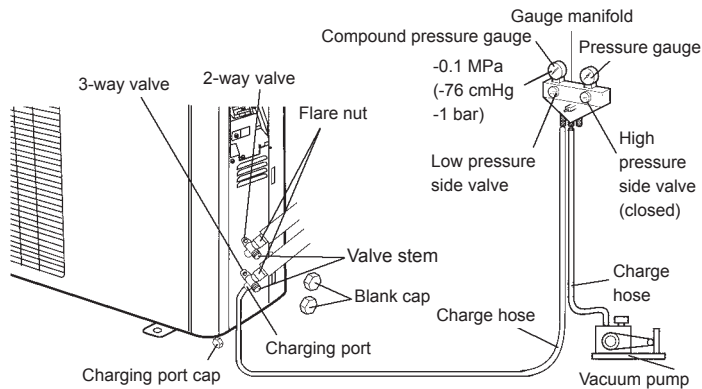

Tightening torque	
Blank cap	20.0 to 25.0 N · m (200 to 250 kgf · cm)
Charging port cap	12.5 to 16.0 N · m (125 to 160 kgf · cm)

## 5.5. Test run

- Perform test operation and check items below.
- For the test operation method, refer to the operating manual.
- The outdoor unit, may not operate, depending on the room temperature. In this case, keep on pressing the MANUAL AUTO button of the indoor unit for more than 10 seconds. The operation indicator lamp and timer indicator lamp will begin to flash simultaneously during cooling test run. Then, heating test run will begin in about three minutes when HEAT is selected by the remote control operation. (Please follow the operating manual for remote control operation.)
- To end test operation, keep on pressing the MANUAL AUTO button of the indoor unit for more than 3 seconds.  
(When the air conditioner is run by pressing the test run button, the OPERATION indicator lamp and TIMER indicator lamp of the indoor unit will simultaneously flash slowly.)

### OUTDOOR UNIT

- (1) Is there any abnormal noise and vibration during operation?
- (2) Will noise, wind, or drain water from the unit disturb the neighbors?
- (3) Is there any gas leakage?

## 6. PUMP DOWN

### 6.1. Pump down

#### PUMP DOWN OPERATION (FORCED COOLING OPERATION)

To avoid discharging refrigerant into the atmosphere at the time of relocation or disposal, recover refrigerant by doing the cooling operation or forced cooling operation according to the following procedure. (When the cooling operation cannot start in winter, and so on, start the forced cooling operation.)

- (1) Do the air purging of the charge hose by connecting the charging hose of gauge manifold to the charging port of 3 way valve and opening the low-pressure valve slightly.
- (2) Close the valve stem of 2 way valve completely.
- (3) Start the cooling operation or following forced cooling operation. Keep on pressing the MANUAL AUTO button of the indoor unit for more than 10 seconds. The operation indicator lamp and timer indicator lamp will begin to flash simultaneously during test run. (The forced cooling operation cannot start if the MANUAL AUTO button is not kept on pressing for more than 10 seconds.)
- (4) Close the valve stem of 3 way valve when the reading on the compound pressure gage becomes 0.05~0 Mpa(0.5~0 kg/cm<sup>2</sup>).
- (5) Stop the operation.
  - Press the START/STOP button of the remote control unit to stop the operation.
  - Press the MANUAL AUTO button when stopping the operation from indoor unit side. (It is not necessary to press on keeping for more than 10 seconds.)

#### CAUTION

During the pump-down operation, make sure that the compressor is turned off before you remove the refrigerant piping.  
Do not remove the connection pipe while the compressor is in operation with 2 way or 3 way valve open. This may cause abnormal pressure in the refrigeration cycle that leads to breakage and even injury.