

AIR CONDITIONER

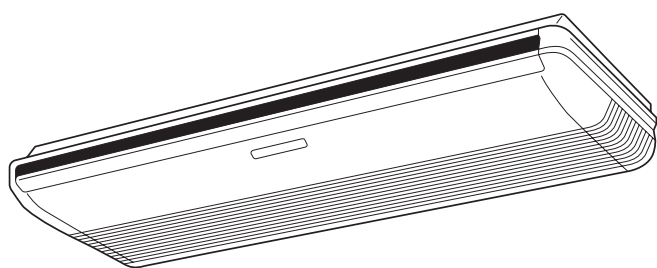

INSTALLATION MANUAL

For authorized service personnel only.

English

INSTALLATIONSANLEITUNG

Nur für autorisiertes Personal.

Deutsch

MANUEL D'INSTALLATION

Pour le personnel agréé uniquement.

Français

MANUAL DE INSTALACIÓN

Solo para personal autorizado.

Español

MANUALE D'INSTALLAZIONE

Ad uso esclusivo del personale autorizzato.

Italiano

ΕΓΧΕΙΡΙΔΙΟ ΕΓΚΑΤΑΣΤΑΣΗΣ

Για εξουσιοδοτημένο προσωπικό σέρβις.

Ελληνικά

MANUAL DE INSTALAÇÃO

Apenas para técnicos autorizados.

Português

РУКОВОДСТВО ПО УСТАНОВКЕ

Для уполномоченного персонала.

Русский

MONTAJ KILAVUZU

Yetkili servis personeli içindir.

Türkçe

INSTALLATION MANUAL

PART NO. 9379122016-02
INDOOR UNIT (Ceiling Type)

Contents

1. SAFETY PRECAUTIONS.....	2
2. ABOUT THE UNIT.....	2
2.1. Precautions for using R410A refrigerant.....	2
2.2. Special tool for R410A.....	2
2.3. Accessories.....	2
2.4. Optional parts.....	3
3. INSTALLATION WORK.....	3
3.1. Selecting an installation location.....	3
3.2. Installation dimension.....	3
3.3. Installation the unit.....	4
4. PIPE INSTALLATION.....	5
4.1. Selecting the pipe material.....	5
4.2. Pipe requirement.....	5
4.3. Flare connection (pipe connection).....	5
4.4. Installing heat insulation.....	6
5. INSTALLING DRAIN PIPE.....	6
6. ELECTRICAL WIRING.....	7
6.1. Wiring system diagram.....	8
6.2. Connection cable preparation.....	8
6.3. Wiring procedure.....	8
7. REMOTE CONTROLLER SETTING.....	8
7.1. Load batteries (R03/LR03 × 2).....	8
7.2. Installing the remote controller holder.....	9
8. FUNCTION SETTING.....	9
8.1. Operation method.....	9
8.2. Function setting.....	9
8.3. Selecting the remote controller signal code.....	10
8.4. Special installation methods.....	10
9. TEST RUN.....	11
10. CHECK LIST.....	11
11. FRESH-AIR INTAKE.....	12
12. OPTIONAL KIT INSTALLATION (OPTION).....	12
13. CUSTOMER GUIDANCE.....	12
14. ERROR CODES.....	12

1. SAFETY PRECAUTIONS

- Be sure to read this Manual thoroughly before installation.
- The warnings and precautions indicated in this Manual contain important information pertaining to your safety. Be sure to observe them.
- Hand this Manual, together with the Operating Manual, to the customer. Request the customer to keep them on hand for future use, such as for relocating or repairing the unit.

 WARNING	This mark indicates procedures which, if improperly performed, might lead to the death or serious injury of the user.
Request your dealer or a professional installer to install the indoor unit in accordance with this Installation Manual. An improperly installed unit can cause serious accidents such as water leakage, electric shock, or fire. If the indoor unit is installed in disregard of the instructions in the Installation Manual, it will void the manufacturer's warranty.	
Do not turn ON the power until all work has been completed. Turning ON the power before the work is completed can cause serious accidents such as electric shock or fire.	
If refrigerant leaks while work is being carried out, ventilate the area. If the refrigerant comes in contact with a flame, it produces a toxic gas.	
Installation work must be performed in accordance with national wiring standards by authorized personnel only.	

 CAUTION	This mark indicates procedures which, if improperly performed, might possibly result in personal harm to the user, or damage to property.
Read carefully all security information before use or install the air conditioner.	
Do not attempt to install the air conditioner or a part of the air conditioner by yourself.	
This unit must be installed by qualified personnel with a capacity certificate for handling refrigerant fluids. Refer to regulation and laws in use on installation place.	
The installation must be carried out in compliance with regulations in force in the place of installation and the installation instructions of the manufacturer.	
This unit is part of a set constituting an air conditioner. It must not be installed alone or with non-authorized by the manufacturer.	
Always use a separate power supply line protected by a circuit breaker operating on all wires with a distance between contact of 3mm for this unit.	
The unit must be correctly grounded and the supply line must be equipped with a differential breaker in order to protect the persons.	
The units are not explosion proof and therefore should not be installed in explosive atmosphere.	

Never touch electrical components immediately after the power supply has been turned off. Electric shock may occur. After turning off the power, always wait 5 minutes before touching electrical components.

This unit contains no user-serviceable parts. Always consult authorized service personnel to repairs.

When moving, consult authorized service personnel for disconnection and installation of the unit.

This appliance is not intended for use by persons (including children) with reduced physical, sensory or mental capabilities, or lack of experience and knowledge, unless they have been given supervision or instruction concerning use of the appliance by a person responsible for their safety. Children should be supervised to ensure that they do not play with the appliance.

2. ABOUT THE UNIT

2.1. Precautions for using R410A refrigerant

WARNING

Do not introduce any substance other than the prescribed refrigerant into the refrigeration cycle. If air enters the refrigeration cycle, the pressure in the refrigeration cycle will become abnormally high and cause the piping to rupture.

If there is a refrigerant leak, make sure that it does not exceed the concentration limit. If a refrigerant leak exceeds the concentration limit, it can lead to accidents such as oxygen starvation.

Do not touch refrigerant that has leaked from the refrigerant pipe connections or other area. Touching the refrigerant directly can cause frostbite.

If a refrigerant leak occurs during operation, immediately vacate the premises and thoroughly ventilate the area. If the refrigerant comes in contact with a flame, it produces a toxic gas.

2.2. Special tool for R410A

WARNING

To install a unit that uses R410A refrigerant, use dedicated tools and piping materials that have been manufactured specifically for R410A use. Because the pressure of R410A refrigerant is approximately 1.6 times higher than the R22, failure to use dedicated piping material or improper installation can cause rupture or injury. Furthermore, it can cause serious accidents such as water leakage, electric shock, or fire.













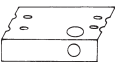

Tool name	Changes
Gauge manifold	The pressure in the refrigerant system is extremely high and cannot be measured with a conventional gauge. To prevent erroneous mixing of other refrigerants, the diameter of each port has been changed. It is recommended to use a gauge manifold with a high pressure display range of -0.1 to 5.3 MPa and a low pressure display range of -0.1 to 3.8 MPa.
Charging hose	To increase pressure resistance, the hose material and base size were changed. (The charging port thread diameter for R410A is 1/2 UNF 20 threads per inch.)
Vacuum pump	A conventional vacuum pump can be used by installing a vacuum pump adapter. Be sure that the pump oil does not back flow into the system. Use one capable for vacuum suction of -100.7 kPa (5 Torr, -755 mmHg).
Gas leakage detector	Special gas leakage detector for R410A refrigerant.

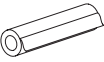
2.3. Accessories

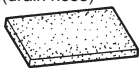
WARNING

For installation purposes, be sure to use the parts supplied by the manufacturer or other prescribed parts.
The use of non-prescribed parts can cause serious accidents such as the unit falling, water leakage, electric shock, or fire.

- The following installation parts are furnished. Use them as required.
- Keep the Installation Manual in a safe place and do not discard any other accessories until the installation work has been completed.

Name and Shape	Q'ty	Name and Shape	Q'ty
Operating Manual 	1	Installation Manual (This manual) 	1
Special nut A (Large flange) 	4	Installation template 	1
For installing indoor unit		For positioning the indoor unit	
Special nut B (Small flange) 	4	Auxiliary pipe assembly 	1
For installing indoor unit		For connecting the piping	
Coupler heat insulator (Small) 	1	Coupler heat insulator (Large) 	2
For indoor side pipe joint (Liquid pipe)		For indoor side pipe joint (Gas pipe)	
Cable tie (Small) 	4	Cable tie (Large) 	4
For fixing the coupler heat insulator		For fixing the coupler heat insulator	
Insulation (drain hose) 	1	VT wire 	1
Adhesive type		For fixing the drain hose L 280 mm	
Remote controller 	1	Battery 	2
For air conditioner operation		For remote controller	
Remote controller holder 	1	Screw (M3 × 12 mm) 	2
		For remote controller holder installation	

2.4. Optional parts

Parts name	Model No.	Summary
Wired remote controller	UTY-RNN*M	Unit control is performed by wired remote controller
Simple remote controller	UTY-RSN*M	For air conditioner operation
Drain pump unit	UTR-DPB24T	
Round duct	UTD-RF204	To take fresh air
External connect kit	UTY-XWZX	For control input/output port

3. INSTALLATION WORK

Especially, the installation place is very important for the split type air conditioner because it is very difficult to move from place to place after the first installation.

3.1. Selecting an installation location

Decide the mounting position together with the customer as follows.

⚠ WARNING

Select installation locations that can properly support the weight of the indoor unit. Install the units securely so that they do not topple or fall.

⚠ CAUTION

Do not install the indoor unit in the following areas:

- Area with high salt content, such as at the seaside. It will deteriorate metal parts, causing the parts to fall or the unit to leak water.
- Area filled with mineral oil or containing a large amount of splashed oil or steam, such as a kitchen. It will deteriorate plastic parts, causing the parts to fall or the unit to leak water.
- Area that generates substances that adversely affect the equipment, such as sulfuric gas, chlorine gas, acid, or alkali. It will cause the copper pipes and brazed joints to corrode, which can cause refrigerant leakage.
- Area that can cause combustible gas to leak, contains suspended carbon fibers or flammable dust, or volatile inflammables such as paint thinner or gasoline. If gas leaks and settles around the unit, it can cause a fire.
- Area where animals may urinate on the unit or ammonia may be generated.

Do not install where there is the danger of combustible gas leakage.

Do not install the unit near a source of heat, steam, or flammable gas.

Install the indoor unit, outdoor unit, power supply cable, transmission cable, and remote controller cable at least 1 m away from a television or radio receivers. The purpose of this is to prevent TV reception interference or radio noise. (Even if they are installed more than 1 m apart, you could still receive noise under some signal conditions.)

If children may approach the unit, take preventive measures so that they cannot reach the unit.

Take precautions to prevent the unit from falling.

- (1) Install the indoor unit on a place having a sufficient strength so that it withstands against the weight of the indoor unit.
- (2) The inlet and outlet ports should not be obstructed; the air should be able to blow all over the room.
- (3) Leave the space required to service the air conditioner.
- (4) Install the unit where connection to the outdoor unit is easy.
- (5) Install the unit where the connection pipe can be easily installed.
- (6) Install the unit where the drain pipe can be easily installed.
- (7) Install the unit where noise and vibrations are not amplified.
- (8) Take servicing, etc., into consideration and leave the spaces. Also install the unit where the filter can be removed.
- (9) Do not install the unit where it will be exposed to direct sunlight.

3.2. Installation dimension

The ceiling rear height as shown in the figure.

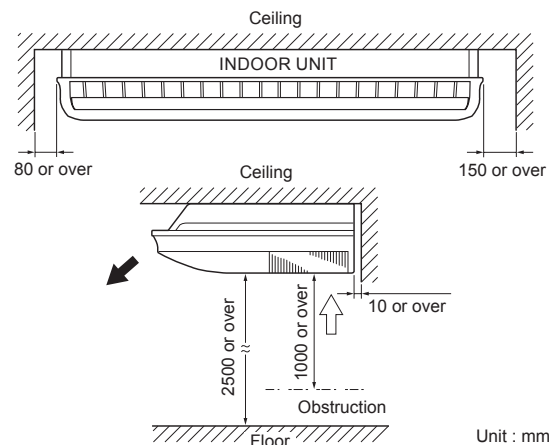

[FOR HALF CONCEALED INSTALLATION]

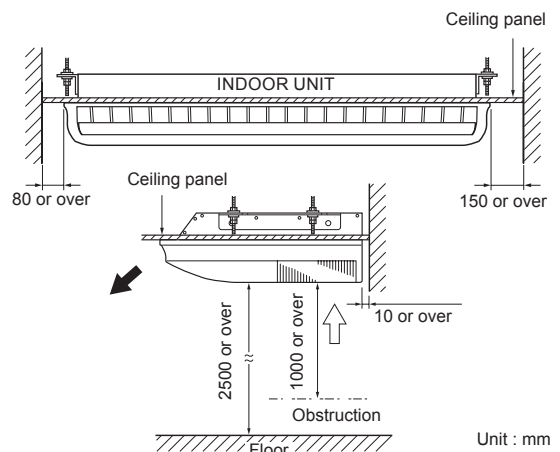

3.3. Installation the unit

⚠ WARNING

Install the air conditioner in a location which can withstand a load of at least five times the weight of the main unit and which will not amplify sound or vibration. If the installation location is not strong enough, the indoor unit may fall and cause injuries.

3.3.1. Preparing indoor unit installation

Remove the intake grille and side cover

- (1) Remove the two air filters.
- (2) Remove the two Intake grilles.
For ④ Left rear drain and ⑤ Left drain: Remove air filters and intake grilles at three places.
- (3) Remove the Side cover A (Right side) and Side cover B (Right and Left side).
For ⑤ Left drain: Remove both the Side cover A (Right and Left side).
- (4) This air conditioner can be set up to intake fresh air.
For information about how to install for fresh-air intake, refer to "11. FRESH-AIR INTAKE".

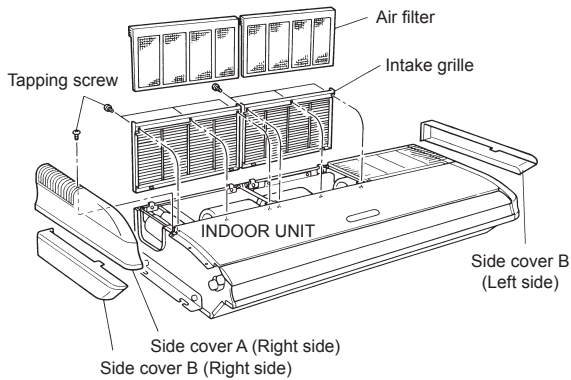

3.3.2. Indoor unit installation

- You can use the accessory template to help you install the indoor unit.
- The template helps you determine the appropriate locations for suspension bolts and pipe opening (drain pipe and connection cable).

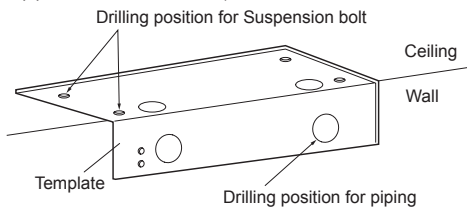

3.3.3. Location of ceiling suspension bolts

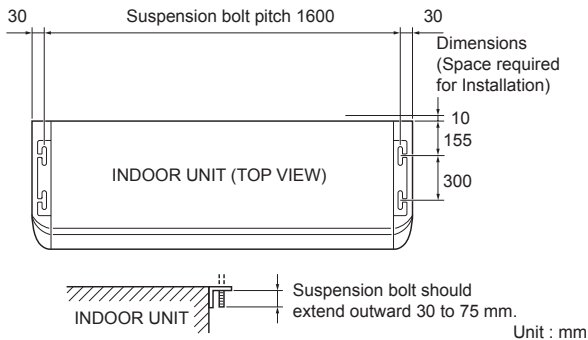

[For Half-Concealed Installation]

- Suspension-bolt pitch should be as shown in the figure.

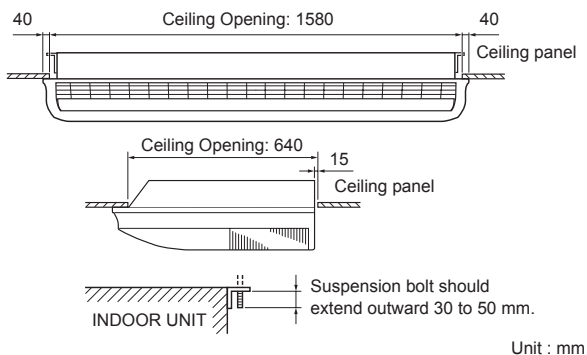

3.3.4. Select piping direction

- Select connection piping and drain piping directions.

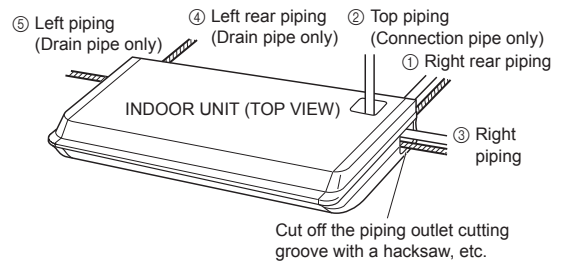

[FOR ④ Left rear piping, ⑤ Left piping]

- Transfer the Drain cap and Drain cap seal.

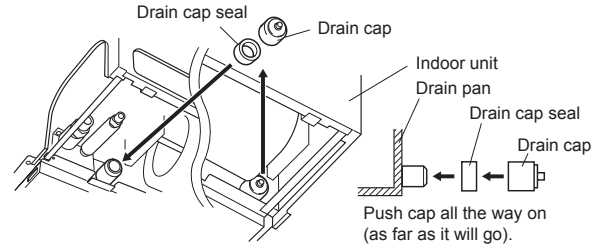

3.3.5. Drilling the holes and attaching the suspension bolts

- (1) Drill $\phi 25$ mm holes at the suspension-bolt locations.
- (2) Install the bolts, then temporarily attach Special nuts A and B and a normal M10 nut to each bolt. (The two special nuts are provided with the unit. The M10 nut must be obtained locally.) Refer to the figure.

Bolt Strength [N (kgf)]	980 to 1470 (100 to 150)
-------------------------	--------------------------

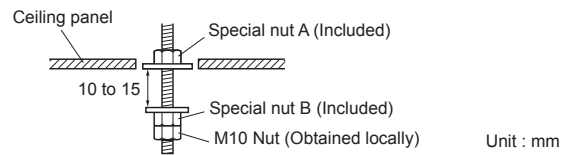

3.3.6. Installing the indoor unit

- (1) Lift unit so that suspension bolts pass through the suspension fittings at the sides (four places), and slide the unit back.

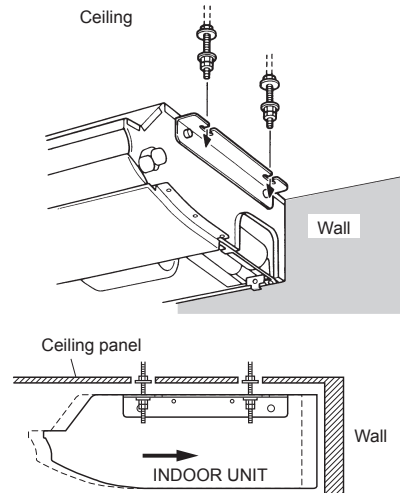

- (2) Fasten the indoor unit into place by tightening-up the special "B" bolts and the M10 nuts. Make sure that unit is secure and will not shift back and forth.

[For Half-Concealed Installation]

When installing the indoor unit in a semi-concealed orientation, make sure to reinforce the insulation of the unit on all sides. Drops of water may fall from the unit if it is not thoroughly insulated.

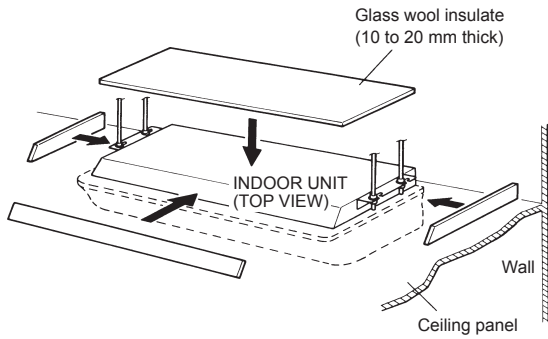

CAUTION

In order to check the drainage, be sure to use a level during installation of the indoor unit. If the installation site of the indoor unit is not level, water leakage may occur.

4. PIPE INSTALLATION

CAUTION

Be more careful that foreign matter (oil, water, etc.) does not enter the piping than with refrigerant R410A models. Also, when storing the piping, securely seal the openings by pinching, taping, etc.

While welding the pipes, be sure to blow dry nitrogen gas through them.

4.1. Selecting the pipe material

CAUTION

Do not use existing pipes.

Use pipes that have clean external and internal sides without any contamination which may cause trouble during use, such as sulfur, oxide, dust, cutting waste, oil, or water.

It is necessary to use seamless copper pipes.
Material : Phosphor deoxidized seamless copper pipes It is desirable that the amount of residual oil is less than 40 mg/10 m.

Do not use copper pipes that have a collapsed, deformed, or discolored portion (especially on the interior surface). Otherwise, the expansion valve or capillary tube may become blocked with contaminants.

Improper pipe selection will degrade performance. As an air conditioner using R410A incurs pressure higher than when using conventional refrigerant, it is necessary to choose adequate materials.

- Thicknesses of copper pipes used with R410A are as shown in the table.
- Never use copper pipes thinner than those indicated in the table even if they are available on the market.

Thicknesses of Annealed Copper Pipes (R410A)

Pipe outside diameter [mm (in.)]	Thickness [mm]
6.35 (1/4)	0.80
9.52 (3/8)	0.80
12.70 (1/2)	0.80
15.88 (5/8)	1.00
19.05 (3/4)	1.20

4.2. Pipe requirement

CAUTION

Refer to the Installation Manual of the outdoor unit for description of the length and the diameter of connecting pipe or for difference of its elevation.

Diameter [mm (in.)]	Liquid	9.52 (3/8)
		Gas

- Use pipe with water-resistant heat insulation.

CAUTION

Install heat insulation around both the gas and liquid pipes. Failure to do so may cause water leaks.

Use heat insulation with heat resistance above 120 °C. (Reverse cycle model only)
In addition, if the humidity level at the installation location of the refrigerant piping is expected to exceed 70 %, install heat insulation around the refrigerant piping.
If the expected humidity level is 70-80 %, use heat insulation that is 15 mm or thicker and if the expected humidity exceeds 80 %, use heat insulation that is 20 mm or thicker. If heat insulation is used that is not as thick as specified, condensation may form on the surface of the insulation.
In addition, use heat insulation with heat conductivity of 0.045 W/(m·K) or less (at 20 °C).

4.3. Flare connection (pipe connection)

4.3.1. Flaring

- Use special pipe cutter and flare tool exclusive for R410A.
 - (1) Cut the connection pipe to the necessary length with a pipe cutter.
 - (2) Hold the pipe downward so that cuttings will not enter the pipe and remove any burrs.
 - (3) Insert the flare nut (always use the flare nut attached to the indoor and outdoor units respectively) onto the pipe and perform the flare processing with a flare tool. Leakage of refrigerant may result if other flare nuts are used.
 - (4) Protect the pipes by pinching them or with tape to prevent dust, dirt, or water from entering the pipes.

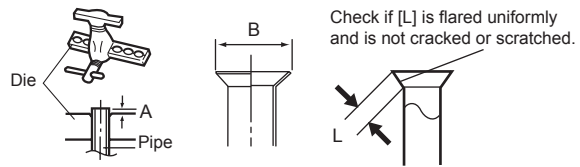

Pipe outside diameter [mm (in.)]	Dimension A [mm]	Dimension B _{±0.4} [mm]
	Flare tool for R410A, clutch type	
6.35 (1/4)	0 to 0.5	9.1
9.52 (3/8)		13.2
12.70 (1/2)		16.6
15.88 (5/8)		19.7
19.05 (3/4)		24.0

When using conventional flare tools to flare R410A pipes, the dimension A should be approximately 0.5 mm more than indicated in the table (for flaring with R410A flare tools) to achieve the specified flaring. Use a thickness gauge to measure the dimension A.

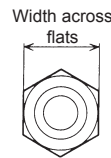

Pipe outside diameter [mm (in.)]	Width across flats of Flare nut [mm]
6.35 (1/4)	17
9.52 (3/8)	22
12.70 (1/2)	26
15.88 (5/8)	29
19.05 (3/4)	36

4.3.2. Bending pipes

- The pipes are shaped by your hands or pipe bender. Be careful not to collapse them.
- Do not bend the pipes at an angle more than 90°.
- When pipes are repeatedly bend or stretched, the material will harden, making it difficult to bend or stretch them any more. Do not bend or stretch the pipes more than 3 times.

CAUTION

To prevent breaking of the pipe, avoid sharp bends.

If the pipe is bent repeatedly at the same place, it will break.

4.3.3. Pipe connection

CAUTION

Be sure to apply the pipe against the port on the indoor unit and the outdoor unit correctly. If the centering is improper, the flare nut cannot be tightened smoothly. If the flare nut is forced to turn, the threads will be damaged.

Do not remove the flare nut from the indoor unit pipe until immediately before connecting the connection pipe.

Do not use mineral oil on flared part. Prevent mineral oil from getting into the system as this would reduce the lifetime of the units.

(1) Remove the filter guide.

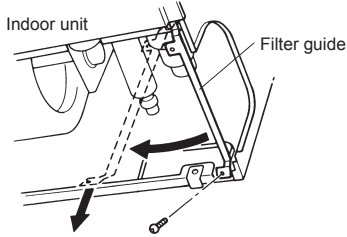

(2) Detach the caps and plugs from the pipes.

(3) Center the pipe against the port on the indoor unit, and then turn the flare nut by hand.

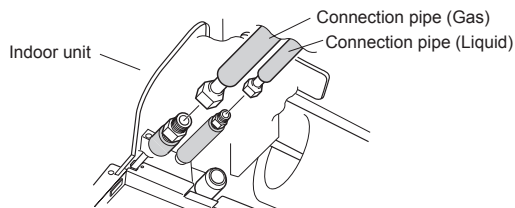

• For ② Top piping and ③ Right piping connections, use the Auxiliary pipe (Gas pipe) provided.

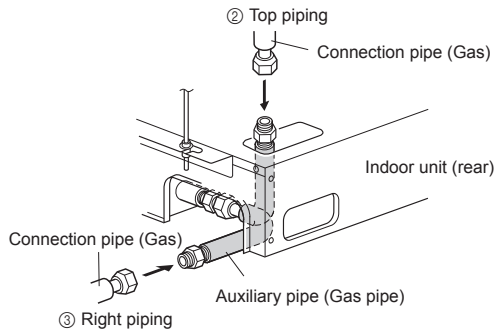

(4) When the flare nut is tightened properly by your hand, hold the body side coupling with a separate spanner, then tighten with a torque wrench. (See the table below for the flare nut tightening torques.)

CAUTION

Hold the torque wrench at its grip, keeping it in the right angle with the pipe, in order to tighten the flare nut correctly.

Tighten the flare nuts with a torque wrench using the specified tightening method. Otherwise, the flare nuts could break after a prolonged period, causing refrigerant to leak and generate a hazardous gas if the refrigerant comes into contact with a flame.

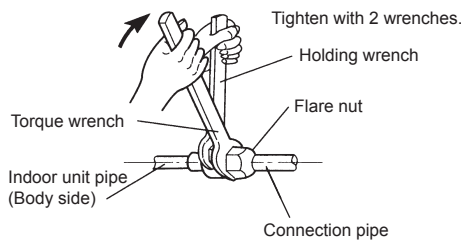

Flare nut [mm (in.)]	Tightening torque [N·m (kgf·cm)]
6.35 (1/4) dia.	16 to 18 (160 to 180)
9.52 (3/8) dia.	32 to 42 (320 to 420)
12.70 (1/2) dia.	49 to 61 (490 to 610)
15.88 (5/8) dia.	63 to 75 (630 to 750)
19.05 (3/4) dia.	90 to 110 (900 to 1,100)

4.4. Installing heat insulation

CAUTION

After checking for gas leaks (refer to the Installation Manual of the outdoor unit), perform this section.

Install heat insulation around both the large (gas) and small (liquid) pipes. Failure to do so may cause water leaks.

After checking for gas leaks, insulate by wrapping insulation around the 2 parts (Gas and Liquid) of the indoor unit coupling, using the coupler heat insulation.

After installing the coupler heat insulation, wrap both ends with vinyl tape so that there is no gap.

Secure both ends of the heat insulation material using cable tie.

And finally fix connection pipe (Liquid) to connection pipe (Gas) by rolling vinyl tape over coupler heat insulation (Gas) and coupler heat insulation (Liquid).

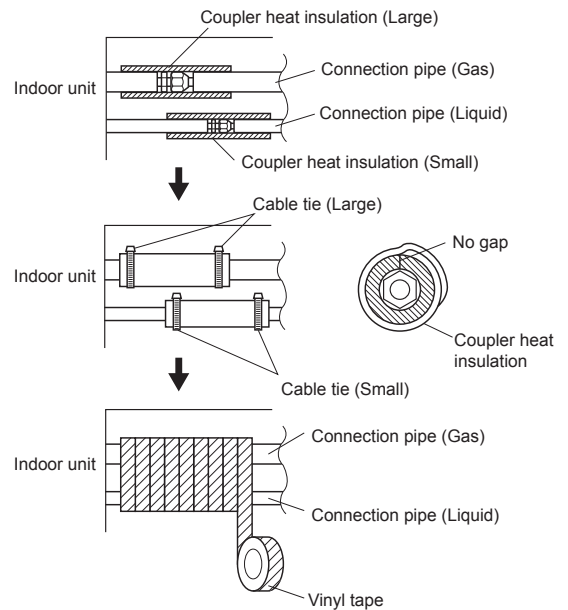

• When using an auxiliary pipe, make sure that the cable tie used is insulated in the same way.

CAUTION

There should be no gaps between the insulation and the unit.

5. INSTALLING DRAIN PIPE

CAUTION

Install the drain pipe in accordance with the instructions in this Installation Manual and keep the area warm enough to prevent condensation. Problems with the piping may lead to water leaks.

- Install the drain pipe with downward gradient (1/50 to 1/100) and so there are no rises or traps in the pipe.
- Use general hard polyvinyl chloride pipe (VP25) [outside diameter 38 mm].
- During installation of the drain pipe, be careful to avoid applying pressure to the drain port of the indoor unit.
- When the pipe is long, install supporters.
- Do not perform air bleeding.
- Always heat insulate (8 mm or over thick) the indoor side of the drain pipe.

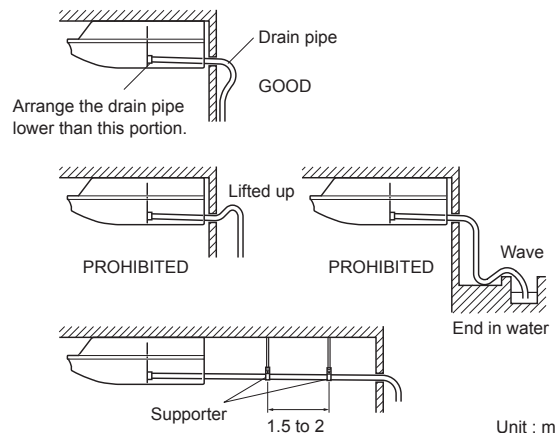

Unit : m

- (1) Install insulation for the drain pipe.
Cut the included insulation material to an appropriate size and adhere it to the pipe.

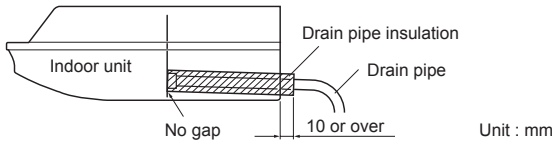
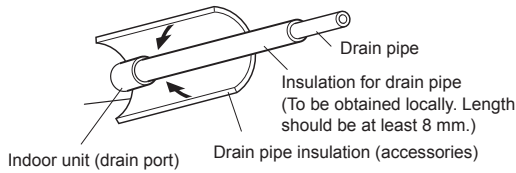

- (2) If "Ⓜ Right rear piping" : fasten the drain pipe with VT wire so that the pipe slopes correctly within the indoor unit.

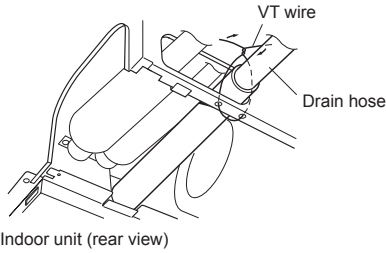

- (3) If the drain hose will not be connected to the right rear piping, cut the hole cover at the points indicated in Fig. (a), and attach it to the piping hole as shown in Fig. (b).

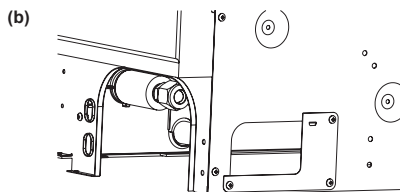
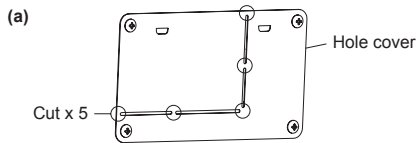

6. ELECTRICAL WIRING

Cable	Cable size (mm ²)	Type	Remarks
Connection cable	1.5 (MIN.)	Type 60245 IEC57	3Cable+Earth (Ground), 1φ230V

Max. Cable Length: Limit voltage drop to less than 2%. Increase cable gauge if voltage drop is 2% or more.

⚠ WARNING

Electrical work must be performed in accordance with this Manual by a person certified under the national or regional regulations. Be sure to use a dedicated circuit for the unit. An insufficient power supply circuit or improperly performed electrical work can cause serious accidents such as electric shock or fire.

Before starting work, check that power is not being supplied to the indoor unit and outdoor unit.

Use the included transmission cables and power cables or ones specified by the manufacturer. Improper connections, insufficient insulation, or exceeding the allowable current can cause electric shock or fire.

For wiring, use the prescribed type of wires, connect them securely, making sure that there are no external forces of the wires applied to the terminal connections. Improperly connected or secured wires can cause serious accidents such as overheating the terminals, electric shock, or fire.

Do not modify the power cables, use extension cables, or use any branches in the wiring. Improper connections, insufficient insulation, or exceeding the allowable current can cause electric shock or fire.

Match the terminal block numbers and connection cable colors with those of the outdoor unit. Erroneous wiring may cause burning of the electric parts.

Securely connect the connection cables to the terminal blocks. In addition, secure the cables with wiring holders. Improper connections, either in the wiring or at the ends of the wiring, can cause a malfunction, electric shock, or fire.

Always fasten the outside covering of the connection cable with the cable clamp. (If the insulator is chafed, electric leakage may occur.)

Securely install the electrical box cover on the unit. An improperly installed electrical box cover can cause serious accidents such as electric shock or fire through exposure to dust or water.

Install sleeves into any holes made in the walls for wiring. Otherwise, a short circuit could result.

Install a earth leakage breaker. In addition, install the earth leakage breaker so that the entire AC main power supply is cut off at the same time. Otherwise, electric shock or fire could result.

Always connect the earth (ground) wire. Improper grounding work can cause electric shocks.

Install the remote controller cable and bus wire so as not to be direct touched with your hand.

- Use ring terminals with insulating sleeves as shown in the figure below to connect to the terminal block.
- Securely clamp the ring terminals to the wires using an appropriate tool so that the wires do not come loose.
- Use the specified wires, connect them securely, and fasten them so that there is no stress placed on the terminals.
- Use an appropriate screwdriver to tighten the terminal screws. Do not use a screwdriver that is too small, otherwise, the screw heads may be damaged and prevent the screws from being properly tightened.
- Do not tighten the terminal screws too much, otherwise, the screws may break.
- See the table 1 for the terminal screw tightening torques.

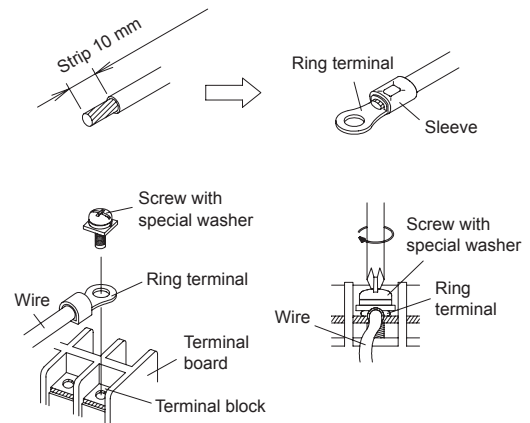

Table 1

Tightening torque [N·m (kgf·cm)]	
M4 screw	1.2 to 1.8 (12 to 18)
M5 screw	2.0 to 3.0 (20 to 30)

⚠ WARNING

Use ring terminals, and tighten the terminal screws to the specified torques. Otherwise, overheating may be produced, and possibly cause heavy damage inside the unit.

6.1. Wiring system diagram

Connection cable to outdoor unit

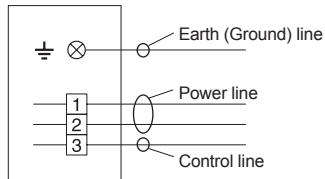

Wired remote controller cable (Option)

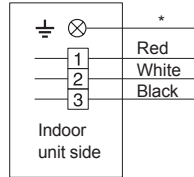

*Earth (Ground) the remote controller if it has a earth (ground) wire.

CAUTION

Tighten the indoor unit connection cable and power supply indoor and outdoor unit, branch box terminal board connections firmly with the terminal board screws. Faulty connection may cause a fire.

If the indoor unit connection cable and power supply are wired incorrectly, the air conditioner may be damaged.

Connect the indoor unit connection cable by matching the numbers of the outdoor and indoor units terminal board numbers as shown in terminal label.

Earth (Ground) both the indoor and outdoor units by attaching a earth (ground) cable.

Unit shall be earthed (grounded) in compliance with the applicable local and national codes.

CAUTION

Be sure to refer to the above diagram for do correct field wiring. Wrong wiring causes malfunction of the unit.

Check local electrical rules and also any specific wiring instructions or limitation.

6.2. Connection cable preparation

Keep the earth (ground) wire longer than the other wires.

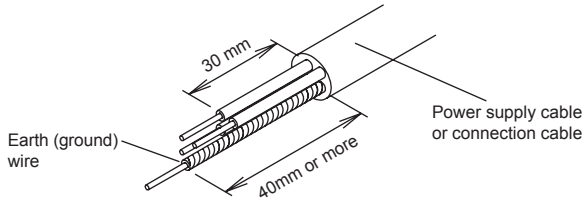

- Use a 4-core wire cable.

6.3. Wiring procedure

CAUTION

Use care not to mistake the power supply cable and connection wires when installing.

- (1) Remove the two tapping screws and pull the Control box downward.

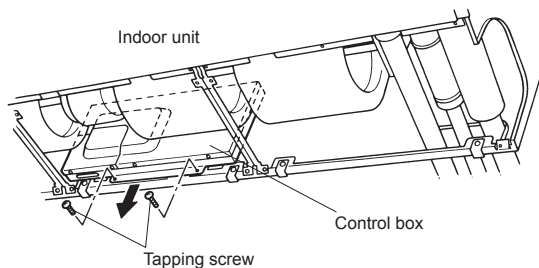

- (2) Remove the Cover A and install the connection cable.

- (3) Please fix the connection cable with cable clamp. And then install the wire cover with screws.

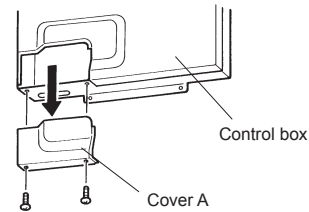

- (4) After wiring is complete, clamp the connection cable with the cable clamp.
- (5) Attach the connection cable and cable clips. Make sure that they are positioned so that they will not interfere with opening and closing of the intake grille or with removal and installation of the air filters.

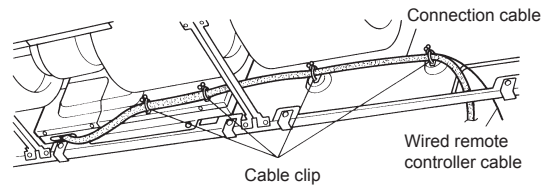
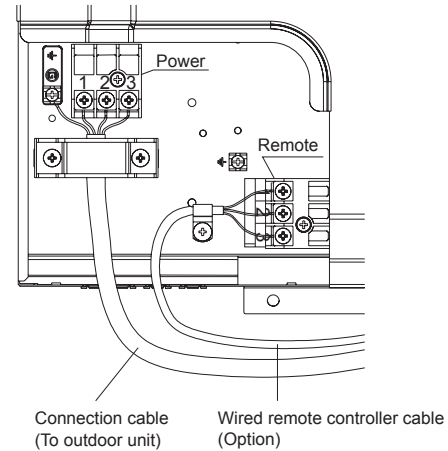

7. REMOTE CONTROLLER SETTING

Refer to the installation manual enclosed with the remote controller when the wired remote controller (option) is used.

7.1. Load batteries (R03/LR03 × 2)

- (1) Press and slide the battery compartment lid on the reverse side to open it. Slide in the direction of the arrow while pressing the ▼ mark.
- (2) Insert batteries.
Be sure to align the battery polarities (+ -) correctly.
- (3) Close the battery compartment lid.

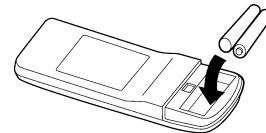

CAUTION

Take care to prevent infants from accidentally swallowing batteries.

When not using the remote controller for an extended period, remove the batteries to avoid possible leakage and damage to the unit.

If leaking battery fluid comes in contact with your skin, eyes, or mouth, immediately wash with copious amounts of water, and consult your physician.

Dead batteries should be removed immediately and disposed of properly, either in a battery collection receptacle or to the appropriate authority.

Do not attempt to recharge dry batteries.

NOTE:

- Never mix new and used batteries, or batteries of different types.
- Batteries should last about 1 year under normal use. If the remote controller's operating range becomes appreciably reduced, replace the batteries and press the RESET button with the tip of a ballpoint pen or other small object.

7.2. Installing the remote controller holder

CAUTION

Check that the indoor unit correctly receives the signal from the remote controller, then install the remote controller holder.

Select the remote controller holder selection site by paying careful attention to the following: Avoid places in direct sunlight. Select a place that will not be affected by the heat from a stove, etc.

- Install the remote controller with a distance of 7 m between the remote controller and the photocell as the criteria. However, when installing the remote controller, check that it operates positively.
- Install the remote controller holder to a wall, pillar, etc., with the tapping screw.

- (1) Mount the holder.
- (2) Set the remote controller.
- (3) To remove the remote controller (when use at hand).

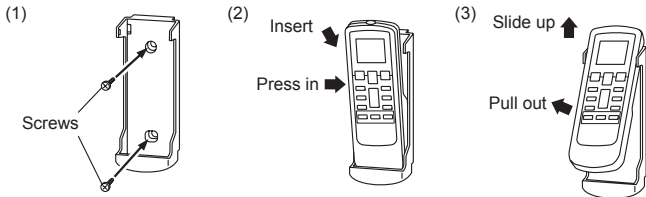

8. FUNCTION SETTING

CAUTION

Confirm whether the wiring work for outdoor unit has been finished.

Confirm whether the cap for electric control box on the outdoor unit is close.

- This procedure changes to the function settings used to control the indoor unit according to the installation conditions. Incorrect settings can cause the indoor unit malfunction.
- After the power is turned on, perform the "FUNCTION SETTING" according to the installation conditions using the remote controller.
- The settings may be selected between the following two: Function Number or Setting Value.
- Settings will not be changed if invalid numbers or setting values are selected.
- Refer to the installation manual enclosed with the remote controller when the wired remote controller (option) is used.

8.1. Operation method

- While pressing the FAN button and SET TEMP. (▲) (▼) simultaneously, press the RESET button to enter the function setting mode.

STEP 1

Selecting the Remote Controller Signal Code

Use the following steps to select the signal code of the remote controller. (Note that the air conditioner cannot receive a signal code if the air conditioner has not been set for the signal code.)

The signal codes that are set through this process are applicable only to the signals in the FUNCTION SETTING. For details on how to set the signal codes through the normal process, refer to remote controller signal code.

- (1) Press SET TEMP. (▲) (▼) button to change the signal code between **A**→**b**→**c**→**d**. Match the code on the display to the air conditioner signal code. (Initially set to **A**) (If the signal code does not need to be selected, press the MODE button and proceed to STEP 2.)
- (2) Press the TIMER MODE button and check that the indoor unit can receive signals at the displayed signal code.
- (3) Press the MODE button to accept the signal code, and proceed to STEP 2.

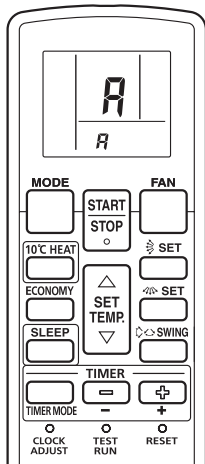

The air conditioner signal code is factory-set to A. Contact your retailer to change the signal code.

The remote controller resets to signal code A when the batteries in the remote controller are replaced. If you use a signal code other than signal code A, reset the signal code after replacing the batteries.

If you do not know the air conditioner signal code setting, try each of the signal codes (**A**→**b**→**c**→**d**) until you find the code which operates the air conditioner.

STEP 2

Selecting the Function Number and Setting Value

- (1) Press the SET TEMP. (▲) (▼) buttons to select the function number. (Press the MODE button to switch between the left and right digits.)
- (2) Press the FAN button to proceed to setting the value. (Press the FAN button again to return to the function number selection.)
- (3) Press the SET TEMP. (▲) (▼) buttons to select the setting value. (Press the MODE button to switch between the left and right digits.)
- (4) Press the TIMER MODE button, and START/STOP button, in the order listed to confirm the settings.
- (5) Press the RESET button to cancel the function setting mode.
- (6) After completing the FUNCTION SETTING, be sure to turn off the power and turn it on again.

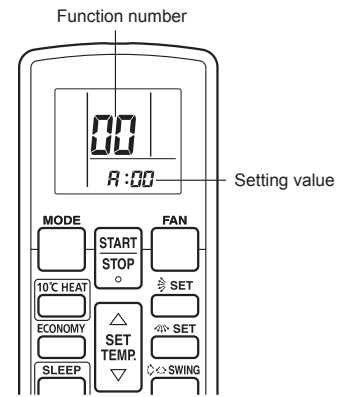

CAUTION

After turning off the power, wait 30 seconds or more before turning on it again. The FUNCTION SETTING doesn't become effective if it doesn't do so.

8.2. Function setting

(1) Filter sign

The indoor unit has a sign to inform the user that it is time to clean the filter. Select the time setting for the filter sign display interval in the table below according to the amount of dust or debris in the room. If you do not wish the filter sign to be displayed, select the setting value for "No indication".

(◆... Factory setting)

Setting description	Function number	Setting value
Standard (2,500 hours)	11	00
Long interval (4,400 hours)		01
Short interval (1,250 hours)		02
No indication		03

(2) Ceiling height

Select the setting values in the table below according to the height of the ceiling.

(◆... Factory setting)

Setting description [m]	Function number	Setting value
Standard (2.5 to 3.0)	20	00
High ceiling (3.0 or more)		01

(3) Cooling room temperature correction

Depending on the installed environment, the room temperature sensor may require a correction.

The settings may be selected as shown in the table below.

(◆... Factory setting)

Setting description	Function number	Setting value
Standard	30	00
Slightly lower control		01
Lower control		02
Warmer control		03

(4) Heating room temperature correction

Depending on the installed environment, the room temperature sensor may require a correction.

The settings may be changed as shown in the table below.

(◆... Factory setting)

Setting description	Function number	Setting value
Standard	31	00
Lower control		01
Slightly warmer control		02
Warmer control		03

(5) Auto restart

Enable or disable automatic system restart after a power outage.

(◆... Factory setting)

Setting description	Function number	Setting value
Yes	40	00
No		01

* Auto restart is an emergency function such as for power failure etc. Do not start and stop the indoor unit by this function in normal operation. Be sure to operate by the control unit, or external input device.

(6) Indoor room temperature sensor switching function

(Only for Wired remote controller)

The following settings are needed using the Wired remote controller temperature sensor.
(◆... Factory setting)

Setting description	Function number	Setting value
No	42	00
Yes		01

* If setting value is "00":

Room temperature is controlled by the indoor unit temperature sensor.

* If setting value is "01":

Room temperature is controlled by either indoor unit temperature sensor or remote controller sensor.

(7) Wireless remote controller signal code

Change the indoor unit Signal Code, depending on the wireless remote controllers.

(◆... Factory setting)

Setting description	Function number	Setting value
A	44	00
B		01
C		02
D		03

(8) External input control

"Operation/Stop" mode or "Forced stop" mode can be selected.

(◆... Factory setting)

Setting description	Function number	Setting value
Operation/Stop mode	46	00
(Setting forbidden)		01
Forced stop mode		02

Setting record

- Record any changes to the settings in the following table.

Setting	Setting Value
(1) Filter sign	
(2) Ceiling height	
(3) Cooling room temperature correction	
(4) Heating room temperature correction	
(5) Auto restart	
(6) Indoor room temperature sensor switching function	
(7) Wireless remote controller signal code	
(8) External input control	

After completing the FUNCTION SETTING, be sure to turn off the power and turn it on again.

8.3. Selecting the remote controller signal code

When two or more air conditioners are installed in a room and the remote controller is operating an air conditioner other than the one you wish to set, change the signal code of the remote controller to operate only the air conditioner you wish to set (four selections possible).

When two or more air conditioners are installed in a room, please contact your retailer to set the individual air conditioner signal codes.

- Confirm the setting of the remote controller signal code and the printed circuit board setting.
If these are not confirmed, the remote controller cannot be used to operate for the air conditioner.

Selecting the Remote Controller Signal Code

Use the following steps to select the signal code of the remote controller. (Note that the air conditioner cannot receive a signal code if the air conditioner has not been set for the signal code.)

- Press the START/STOP button until only the clock is displayed on the remote controller display.
- Press the MODE signal button for at least 5 seconds to display the current signal code (initially set to **A**).
- Press SET TEMP. (▲) (▼) button to change the signal code between **A-b-c-d**. Match the code on the display to the air conditioner signal code.
- Press the MODE button again to return to the clock display. The signal code will be changed.

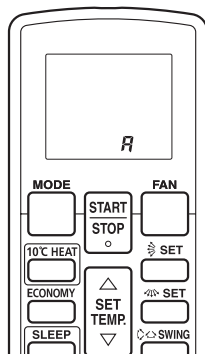

If no buttons are pressed within 30 seconds after the signal code is displayed, the system returns to the original clock display. In this case, start again from step 1.

The air conditioner signal code is set to A prior to shipment. Contact your retailer to change the signal code.

The remote controller resets to signal code A when the batteries in the remote controller are replaced. If you use a signal code other than signal code A, reset the signal code after replacing the batteries.

If you do not know the air conditioner signal code setting, try each of the signal codes (**A-b-c-d**) until you find the code which operates the air conditioner.

8.4. Special installation methods

This possible only the wired remote controller (Option)

CAUTION

When setting DIP switches, do not touch any other parts on the circuit board directly with your bare hands.

Be sure to turn off the main power.

8.4.1. Group control system

A number of indoor units can be operated at the same time using a single remote controller.

- Wiring method (indoor unit to remote controller)

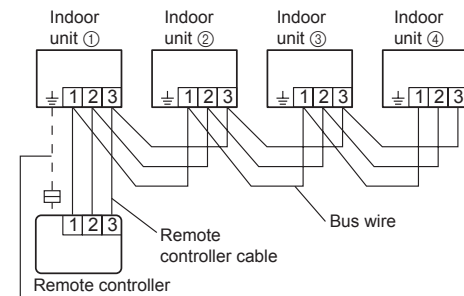

When earth (ground) wire is necessary

- DIP switch setting (Indoor unit)

Set the R.C. address of each indoor unit using the DIP switches on the indoor unit circuit board. (See the following table and figure.)

The DIP switches are normally set to make the R.C. address 00.

Indoor unit	R.C. address	DIP SWITCH No.			
		1	2	3	4
①	00	OFF	OFF	OFF	OFF
②	01	ON	OFF	OFF	OFF
③	02	OFF	ON	OFF	OFF
④	03	ON	ON	OFF	OFF
⑤	04	OFF	OFF	ON	OFF
⑥	05	ON	OFF	ON	OFF
⑦	06	OFF	ON	ON	OFF
⑧	07	ON	ON	ON	OFF
⑨	08	OFF	OFF	OFF	ON
⑩	09	ON	OFF	OFF	ON
⑪	10	OFF	ON	OFF	ON
⑫	11	ON	ON	OFF	ON
⑬	12	OFF	OFF	ON	ON
⑭	13	ON	OFF	ON	ON
⑮	14	OFF	ON	ON	ON
⑯	15	ON	ON	ON	ON

Example : R.C. address 03

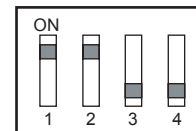

NOTE

Be sure to set the R.C. address sequentially.

◆ Settings when simultaneous multi included.

(3) Remote controller setting

1. Turn on all of the indoor units.
Turn on the indoor unit with the R.C. address 00 last. (Within 1 minute)
2. Set the refrigerant circuit address. (Assign the same number to all of the indoor units connected to an outdoor unit.)

Refrigerant circuit address	Function Number	Setting Value
	02	00~15

- (4) Set the "primary" and "secondary" settings. (Set the indoor unit that is connected to the outdoor unit using a transmission cable as the "primary".)

	Function Number	Setting Value
Primary	51	00
Secondary		01

After completing the function settings, turn off all of the indoor units, and then turn them back on.

* If error code 21, 22, 24 or 27 is displayed, there may be an incorrect setting. Perform the remote controller setting again.

NOTE

- When different indoor unit models are connected using the group control system, some functions may no longer be available.
- If the group control system contains multiple units that are operated simultaneously, connect and set the units as shown below.
- Auto-changeover operates under the same mode with model R.C. address 00.
- It should not be connected to any other Gr that is not of the same series (A**G only).

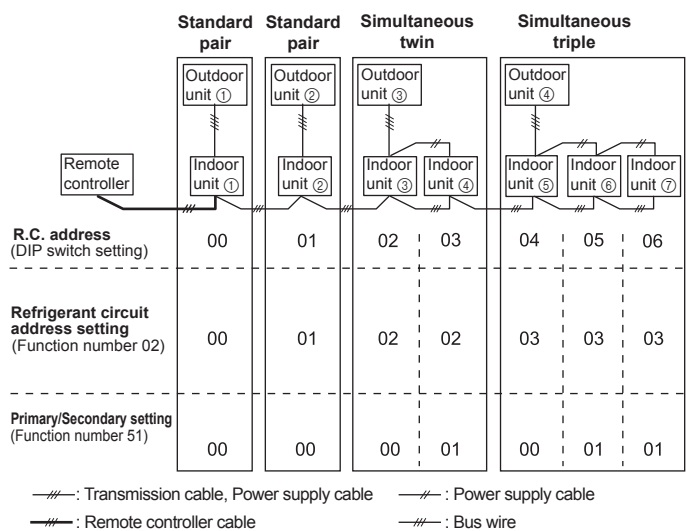

*Make sure that the indoor unit with the R.C. address 0 is connected to the outdoor unit using a transmission cable.

8.4.2. Dual remote controllers

- 2 separate remote controllers can be used to operate the indoor units.
- The timer and self-diagnosis functions cannot be used on the secondary unit of remote controller.

(1) Wiring method (indoor unit to remote controller)

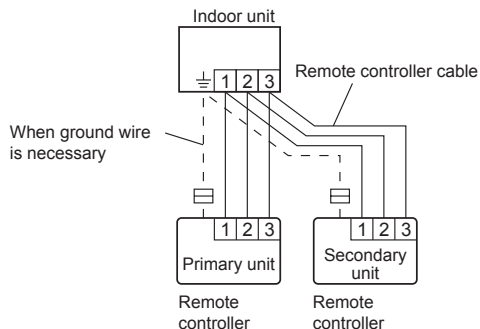

(2) Remote controller DIP switch 1 setting

Set the remote controller DIP switch 1-No. 2 according to the following table.

	DIP SW 1-No. 2
Primary unit	OFF
Secondary unit	ON

9. TEST RUN

CHECK ITEMS

- (1) Is operation of each button on the remote controller normal?
 - (2) Does each lamp light normally?
 - (3) Do not air flow direction louvers operate normally?
 - (4) Is the drain normal?
 - (5) Is there any error noise and vibration during operation?
- Do not operate the air conditioner in the running state for a long time.
 - Test running

When the air conditioner is run by pressing the remote controller TEST RUN button, the OPERATION and TIMER Lamps flash slowly at the same time.

[Operation method]

- For the operation method, refer to the operating manual.
- The outdoor unit may not operate depending on the room temperature. In this case, press the TEST RUN button on the remote controller while the air conditioner is running. (Point the transmitter section of the remote controller toward the air conditioner and press the TEST RUN button with the tip of a ballpoint pen, etc.)
- To end test operation, press the remote controller START/STOP button. (When the air conditioner is running by pressing the TEST RUN button, the OPERATION Lamp and TIMER Lamp will simultaneously flash slowly.)

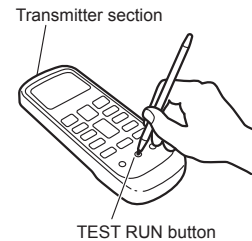

[Using the wired remote controller] (Option)

- For the operation method, refer to the operating manual.
- (1) Stop the air conditioner operation.
- (2) Press the MODE button and the FAN button simultaneously for 2 seconds or more to start the test run.
- (3) Press the START/STOP button to stop the test run.

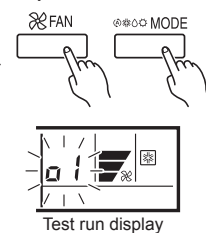

If "CO" appears in the R.C. address display, there is a remote controller error. Refer to the installation manual included with the remote controller.

R.C. address	Error code	Content
00	15	Incompatible indoor unit is connected
00	12	Indoor unit ↔ remote controller communication error

10. CHECK LIST

Pay special attention to the check items below when installing the indoor unit (s). After installation is complete, be sure to check the following check items again.

CHECK ITEMS	If not performed correctly	CHECK BOX
Has the indoor unit been installed correctly?	Vibration, noise, indoor unit may drop	
Has there been a check for gas leaks (refrigerant pipes)?	No cooling, No heating	
Has heat insulation work been completed?	Water leakage	
Does water drain easily from the indoor units?	Water leakage	
Are the wires and pipes all connected completely?	No operation, heat or burn damage	
Is the connection cable the specified thickness?	No operation, heat or burn damage	
Are the inlets and outlets free of any obstacles?	No cooling, No heating	
After installation is completed, has the proper operation and handling been explained to the user?		

11. FRESH-AIR INTAKE

- (1) Open up the knockout hole for the fresh-air intake, as shown in the figure. (If using half-concealed installation, open up the top knockout hole instead.)

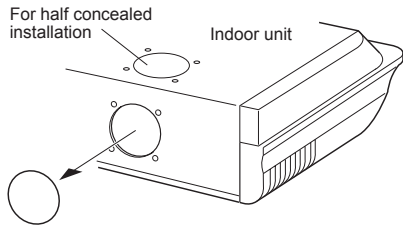

⚠ CAUTION

When removing the cabinet (iron plate), be careful not to damage the indoor unit internal parts and surrounding area (outer case).

When processing the cabinet (iron plate), be careful not to injure yourself with burrs, etc.

- (2) Fasten the round flange (optional) to the fresh-air intake, as shown in the figure. (If using half-concealed installation, attach to the top.)

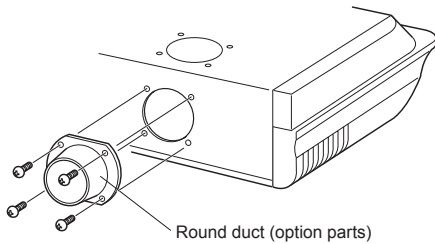

[After completing "3. INSTALLATION WORK"...]

- (3) Connect the duct to the round flange.
 (4) Seal with a band and vinyl tape, etc. so that air does not leak from the connection.

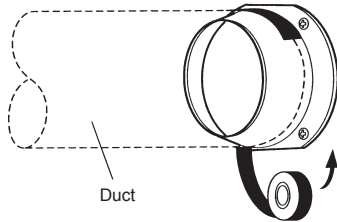

12. OPTIONAL KIT INSTALLATION (OPTION)

⚠ WARNING

Regulation of cable differs from each locality, refer in accordance with local rules.

This air conditioner can be connected with the following optional kits. Refer to each installation manual for the method of installing optional parts.

Option type	Connector No.
Float switch terminal (Drain pump unit)	CN9
Drain pump terminal (Drain pump unit)	CN106
External input	CN102
External output	CN103

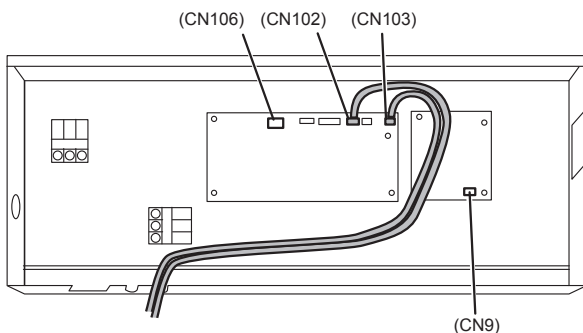

13. CUSTOMER GUIDANCE

Explain the following to the customer in accordance with the operating manual:

- (1) Starting and stopping method, operation switching, temperature adjustment, timer, air flow switching, and other remote controller operations.
 - (2) Air filter removal and cleaning, and how to use the air louvers.
 - (3) Give the operating and Installation Manuals to the customer.
 - (4) If the signal code is changed, explain to the customer how it changed (the system returns to signal code A when the batteries in the remote controller are replaced).
- * (4) is applicable to using wireless remote controller.

14. ERROR CODES

If you use a wired remote controller, error codes will appear on the remote controller display. If you use a wireless remote controller, the lamp on the photo detector unit will output error codes by way of blinking patterns. See the lamp blinking patterns and error codes in the table below.

Error display			Wired remote controller Error code	Description
OPERATION lamp (green)	TIMER lamp (orange)	ECONOMY lamp (green)		
●(1)	●(1)	◇	11	Serial communication error
●(1)	●(2)	◇	12	Wired remote controller communication error
●(1)	●(5)	◇	15	Check run unfinished
●(2)	●(1)	◇	21	R.C. address or Refrigerant circuit address setting error [Simultaneous Multi]
●(2)	●(2)	◇	22	Indoor unit capacity error
●(2)	●(3)	◇	23	Combination error
●(2)	●(4)	◇	24	• Connection R.C. address error (indoor secondary unit) [Simultaneous Multi] • Connection R.C. address error (indoor unit or branch unit) [Flexible Multi]
●(2)	●(7)	◇	27	Primary unit, secondary unit set-up error [Simultaneous Multi]
●(3)	●(1)	◇	31	Power supply interruption error
●(3)	●(2)	◇	32	Indoor unit PCB model information error
●(3)	●(5)	◇	35	Manual auto switch error
●(4)	●(1)	◇	41	Room temp. sensor error
●(4)	●(2)	◇	42	Indoor unit Heat Ex. Middle temp. sensor error
●(5)	●(1)	◇	51	Indoor unit fan motor error
●(5)	●(3)	◇	53	Drain pump error
●(5)	●(7)	◇	57	Damper error
●(5)	●(15)	◇	5U	Indoor unit error
●(6)	●(2)	◇	62	Outdoor unit main PCB model information error or communication error
●(6)	●(3)	◇	63	Inverter error
●(6)	●(4)	◇	64	Active filter error, PFC circuit error
●(6)	●(5)	◇	65	Trip terminal L error
●(6)	●(10)	◇	6A	Display PCB microcomputers communication error
●(7)	●(1)	◇	71	Discharge temp. sensor error
●(7)	●(2)	◇	72	Compressor temp. sensor error
●(7)	●(3)	◇	73	Outdoor unit Heat Ex. liquid temp. sensor error

●(7)	●(4)	◇	74	Outdoor temp. sensor error
●(7)	●(5)	◇	75	Suction Gas temp. sensor error
●(7)	●(6)	◇	76	• 2-way valve temp. sensor error • 3-way valve temp. sensor error
●(7)	●(7)	◇	77	Heat sink temp. sensor error
●(8)	●(2)	◇	82	• Sub-cool Heat Ex. gas inlet temp. sensor error • Sub-cool Heat Ex. gas outlet temp. sensor error
●(8)	●(3)	◇	83	Liquid pipe temp. sensor error
●(8)	●(4)	◇	84	Current sensor error
●(8)	●(6)	◇	86	• Discharge pressure sensor error • Suction pressure sensor error • High pressure switch error
●(9)	●(4)	◇	94	Trip detection
●(9)	●(5)	◇	95	Compressor rotor position detection error (permanent stop)
●(9)	●(7)	◇	97	Outdoor unit fan motor 1 error
●(9)	●(8)	◇	98	Outdoor unit fan motor 2 error
●(9)	●(9)	◇	99	4-way valve error
●(9)	●(10)	◇	9A	Coil (expansion valve) error
●(10)	●(1)	◇	A1	Discharge temp. error
●(10)	●(3)	◇	A3	Compressor temp. error
●(10)	●(4)	◇	A4	High pressure error
●(10)	●(5)	◇	A5	Low pressure error
●(13)	●(2)	◇	J2	Branch boxes error [Flexible Multi]

Display mode ● : 0.5s ON / 0.5s OFF

◇ : 0.1s ON / 0.1s OFF

() : Number of flashing

Troubleshooting

[Troubleshooting with the indoor display]

Troubleshooting at the display is possible either on the wired or wireless remote controller.

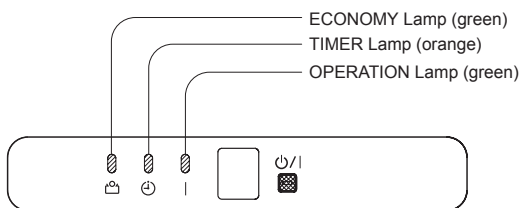

[Troubleshooting at the remote controller LCD]

This is possible only on the wired remote controller.

[Self-diagnosis]

If an error occurs, the following display will be shown.

("Er" will appear in the set room temperature display.)

