

**SPLIT TYPE
ROOM AIR CONDITIONER
WALL MOUNTED^{type}
INVERTER**

SERVICE INSTRUCTION

Models	Indoor unit	Outdoor unit
	AS*G07LMCA	AO*G07LMCA
	AS*G09LMCA	AO*G09LMCA
	AS*G12LMCA	AO*G12LMCA
	AS*G14LMCA	AO*G14LMCA

Refrigerant

R410A

CONTENTS

1. DESCRIPTION OF EACH CONTROL OPERATION

1. COOLING OPERATION.....	01-01
2. HEATING OPERATION.....	01-02
3. DRY OPERATION.....	01-03
4. AUTO CHANGEOVER OPERATION.....	01-04
5. INDOOR FAN CONTROL.....	01-05
6. OUTDOOR FAN CONTROL.....	01-07
7. LOUVER CONTROL.....	01-08
8. COMPRESSOR CONTROL.....	01-09
9. TIMER OPERATION CONTROL.....	01-10
10. ELECTRONIC EXPANSION VALVE CONTROL.....	01-13
11. TEST OPERATION CONTROL.....	01-13
12. PREVENT TO RESTART FOR 3 MINUTES (3 MINUTES ST).....	01-13
13. FOUR-WAY VALVE EXTENSION SELECT.....	01-13
14. AUTO RESTART.....	01-14
15. MANUAL AUTO OPERATION (Indoor unit body operation).....	01-14
16. FORCED COOLING OPERATION.....	01-14
17. COMPRESSOR PREHEATING.....	01-15
18. 10°C HEAT OPERATION.....	01-15
19. ECONOMY OPERATION.....	01-15
20. OUTDOOR UNIT LOW NOISE OPERATION.....	01-15
21. POWERFUL OPERATION.....	01-16
22. DEFROST OPERATION CONTROL.....	01-17
23. OFF DEFROST OPERATION CONTROL.....	01-19
24. VARIOUS PROTECTIONS.....	01-20

2. TROUBLE SHOOTING

2-1 ERROR DISPLAY.....	02-01
2-1-1 INDOOR UNIT AND WIRED REMOTE CONTROLLER DISPLAY.....	02-01
2-1-2 WIRED REMOTE CONTROLLER DISPLAY (OPTION).....	02-02
2-2 TROUBLE SHOOTING WITH ERROR CODE.....	02-03
2-3 TROUBLE SHOOTING WITH NO ERROR CODE.....	02-23
2-4 SERVICE PARTS INFORMATION.....	02-28

3. APPENDING DATA

3-1 FUNCTION SETTING.....	03-01
3-1-1 INDOOR UNIT.....	03-01
3-1-2 Procedures to change the Function Setting for wireless RC.....	03-03
3-2 Thermistor Resistance Values.....	03-05
3-2-1 INDOOR UNIT.....	03-05
3-2-2 OUTDOOR UNIT.....	03-05

WALL MOUNTED type INVERTER

1 . DESCRIPTION OF EACH
CONTROL OPERATION

1. COOLING OPERATION

A sensor (room temperature thermistor) built in the indoor unit body will usually perceive difference or variation between a set temperature and present room temperature, and controls the operation frequency of the compressor.

- * If the room temperature is 2°C higher than a set temperature, the compressor operation frequency will attain to maximum performance.
- * If the room temperature is some degrees lower than a set temperature, the compressor will be stopped.
- * When the room temperature is between +2°C to -2.5°C of the setting temperature, the compressor frequency is controlled within the range shown in Table1. However, the maximum frequency is limited in the range shown in Fig.1 based on the indoor fan mode and the outdoor temperature.

(Table 1 : Compressor frequency range)

	Minimum frequency	Maximum frequencyII	Maximum frequencyI
AO*G07/09LMCA	22rps	76rps	79rps
AO*G12/14LMCA	18rps	80rps	96rps

When the compressor operates for 30 minutes continuously at over the maximum frequencyII, the maximum frequency is changed from Maximum FrequencyI to Maximum FrequencyII.

(Fig.1 : Outdoor temperature zone)

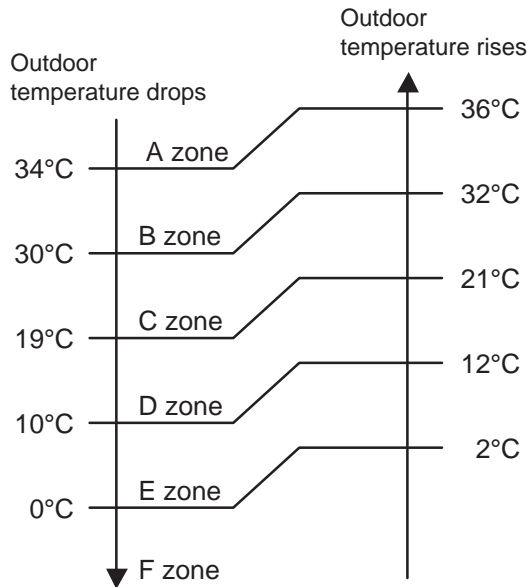

(Table 2 : Limit of maximum speed based on outdoor temperature)

	Outdoor temp. zone	Indoor fan mode			
		Hi	Me	Lo	Quiet
AO*G07/09LMCA	A zone	79rps	61rps	52rps	37rps
	B zone	79rps	61rps	52rps	37rps
	C zone	79rps	61rps	52rps	37rps
	D zone	64rps	55rps	49rps	36rps
	E zone	64rps	55rps	49rps	36rps
	F zone	64rps	55rps	49rps	36rps
AO*G12LMCA	A zone	96rps	61rps	51rps	33rps
	B zone	96rps	61rps	51rps	33rps
	C zone	96rps	61rps	51rps	33rps
	D zone	68rps	54rps	48rps	33rps
	E zone	68rps	54rps	48rps	33rps
	F zone	68rps	54rps	48rps	33rps
AO*G14LMCA	A zone	96rps	61rps	51rps	33rps
	B zone	96rps	61rps	51rps	33rps
	C zone	96rps	61rps	51rps	33rps
	D zone	73rps	48rps	36rps	27rps
	E zone	73rps	48rps	36rps	27rps
	F zone	73rps	48rps	36rps	27rps

2. HEATING OPERATION

A sensor (room temperature thermistor) built in the indoor unit body will usually perceive difference or variation between a set temperature and present room temperature, and controls the operation frequency of the compressor.

* If the room temperature is lower by 3°C than a set temperature, the compressor operation frequency will attain to maximum performance.

* If the room temperature is some degrees higher than a set temperature, the compressor will be stopped.

* When the room temperature is between +2.5°C to -3°C of the setting temperature, the compressor frequency is controlled within the range shown in Table 3. However, the maximum frequency is limited shown in Table 4 based on the fan mode.

(Table 3 : Compressor frequency range)

	Minimum frequency	Maximum frequency
AO*G07/09LMCA	22rps	99rps
AO*G12LMCA	18rps	120rps
AO*G14LMCA	18rps	119rps

3. DRY OPERATION

The compressor frequency shall change according to the temperature, set temperature, and room temperature variation which the room temperature sensor of the indoor unit body has detected as shown in the Table 5.

However, after the compressor is driven, the indoor unit shall run at operation frequency of 64rps (07/09 type), 61rps (12/14 type), for a minute.

(Table 5 : Compressor frequency in Dry mode)

		Operating frequency			Operating frequency
07LMCA 09LMCA	X zone	37rps	12LMCA 14LMCA	X zone	33rps
	J zone	28rps		J zone	25rps
	Y zone	0rps		Y zone	0rps

(Fig.2 : Compressor control based on room temperature)

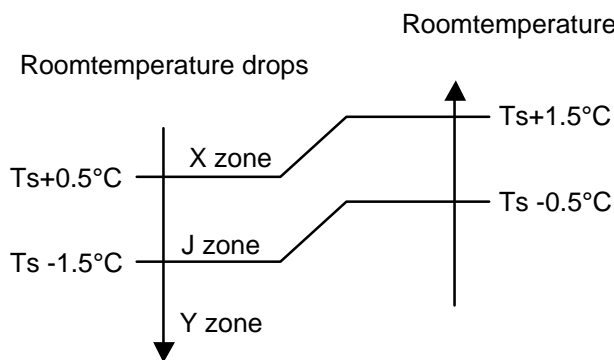

4. AUTO CHANGEOVER OPERATION

When the air conditioner is set to the AUTO mode by remote control, operation starts in the optimum mode from among the Heating, Cooling, Dry and Monitoring modes. During operation, the optimum mode is automatically switched in accordance with temperature changes. The temperature can be set between 18°C and 30°C in 1°C steps.

(Fig. 3 : Operation flow chart in Auto changeover)

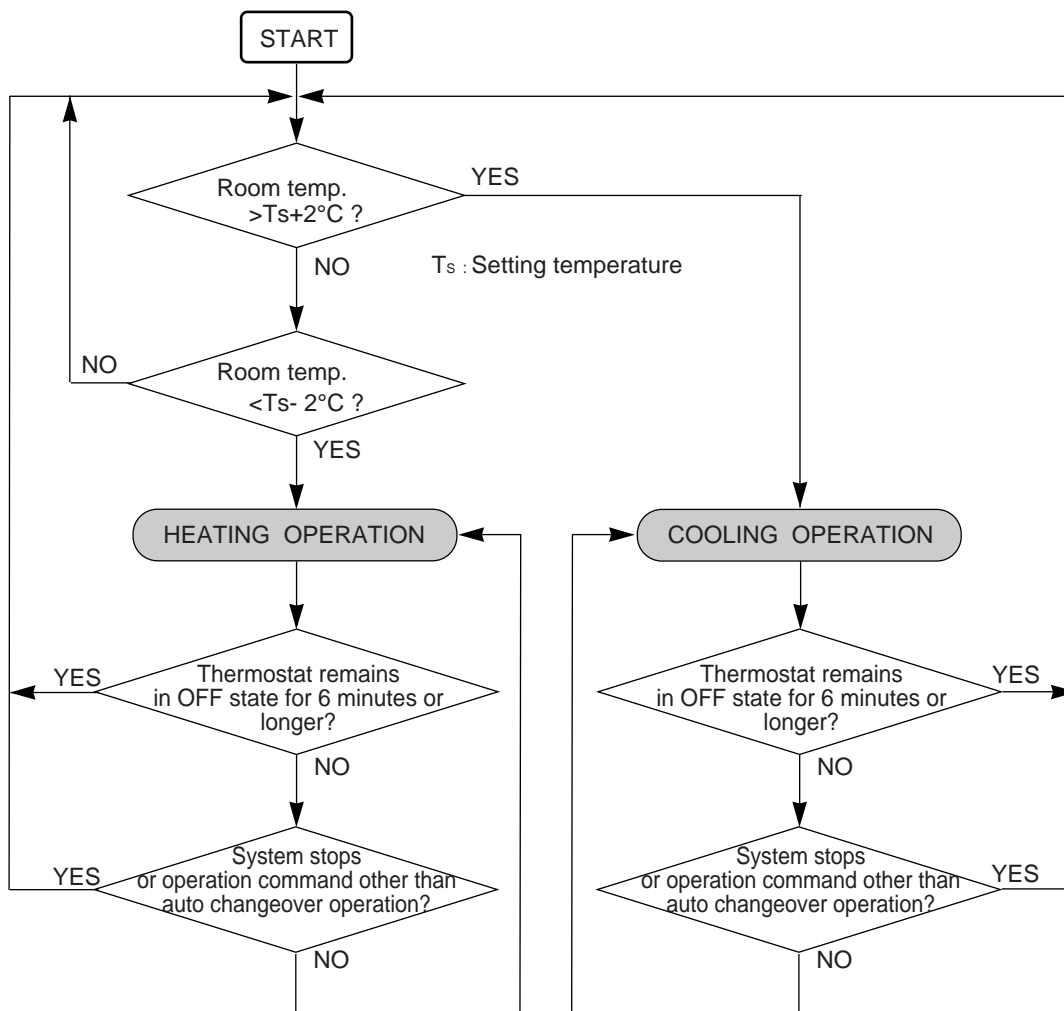

5. INDOOR FAN CONTROL

1. Fan speed

(Table 6 : Indoor fan speed)

() model 14

() model 14

Operation mode	Air flow mode	Speed (rpm)	Operation mode	Air flow mode	Speed (rpm)
Heating	Powerful	1380 (1420)	Cooling/ Fan	Powerful	1380 (1420)
	Hi	1320 (1360)		Hi	1320 (1360)
	Me+	1280 (1330)		Me	1160 (1220)
	Me	1160 (1220)		Lo	930 (990)
	Lo	980 (1040)		Quiet	680 (750)
	Quiet	710 (770)		*Soft Quiet	600 (670)
	Cool air prevention	600 (600)	Dry	X zone	680 (750)
	S-Lo	480 (480)		J zone	660 (730)

*Note, during Economy operation and operation mode is Fan, air flow is 1 step downs. (Hi > Me, Me > Lo, Lo > Quiet, Quiet > Soft Quiet)

2. FAN OPERATION

The airflow can be switched in 5 steps such as Auto, Quiet, Lo, Me, Hi, while the indoor fan only runs. When fan mode is set at [Auto], it operates on [Me] fan Speed.

3. COOLING OPERATION

Switch the airflow [Auto], and the indoor fan motor will run according to a room temperature, as shown in Figure3.

On the other hand, if switched in [Hi]~[Quiet], the indoor motor will run at a constant airflow of [Cool] operation modes Quiet, Lo, Me, Hi, as shown in Table 6.

(Fig.4 : Airflow change - over (Cooling : Auto))

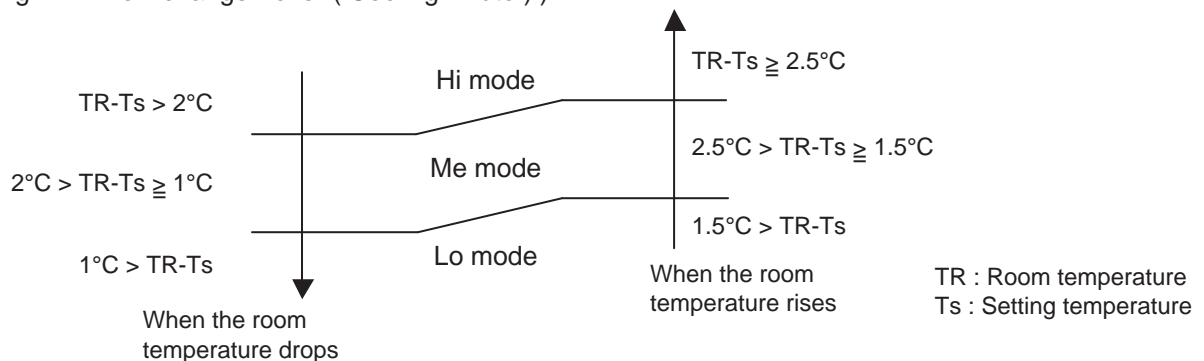

4. DRY OPERATION

Refer to the Table 6.

During the dry mode operation, the fan speed setting can not be changed.

5. HEATING OPERATION

Switch the airflow [Auto], and the indoor fan motor will run according to a room temperature, as shown in Fig. 5

On the other hand, if switched in [Hi] ~ [Quiet], the indoor motor will run at a constant airflow of [Heat] operation modes Quiet, Lo, Me, High, as shown in Table 6.

(Fig.5 : Airflow change - over (Heating : Auto))

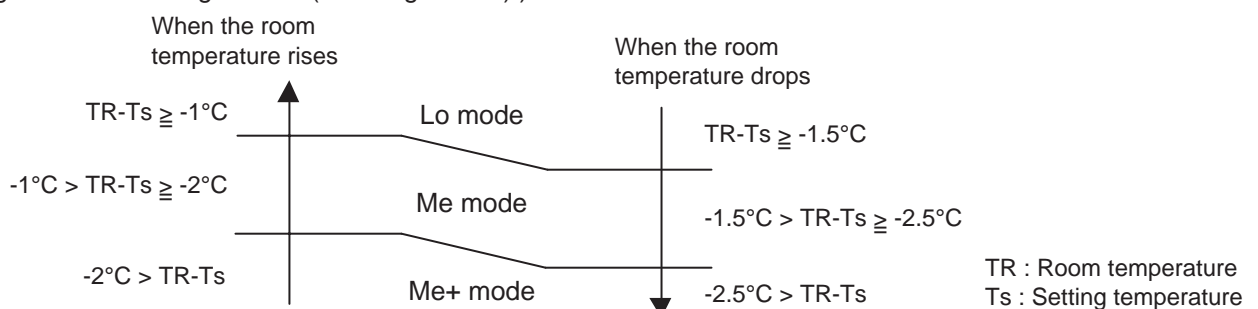

6. COOL AIR PREVENTION CONTROL (Heating mode)

The maximum value of the indoor fan speed is set as shown in Fig.6 based on the detected temperature by the indoor heat-exchanger sensor on heating mode.

(Fig.6 : Cool air prevention control)

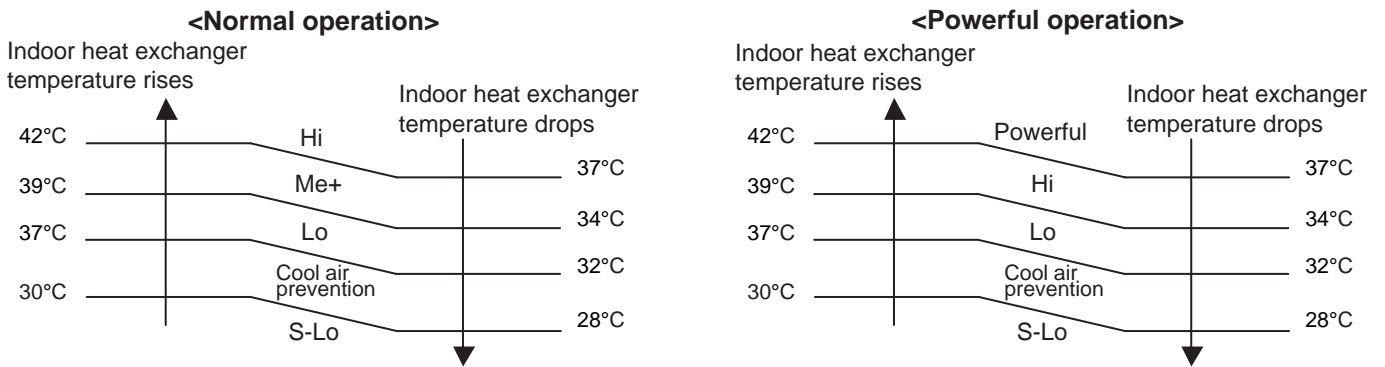

7. MOISTURE RETURN PREVENTION CONTROL (Cooling mode& Dry mode)

Switch the airflow [Auto] at cooling mode, and the indoor fan motor will run as shown in Fig.7.

(Fig.7 : Indoor fan control)

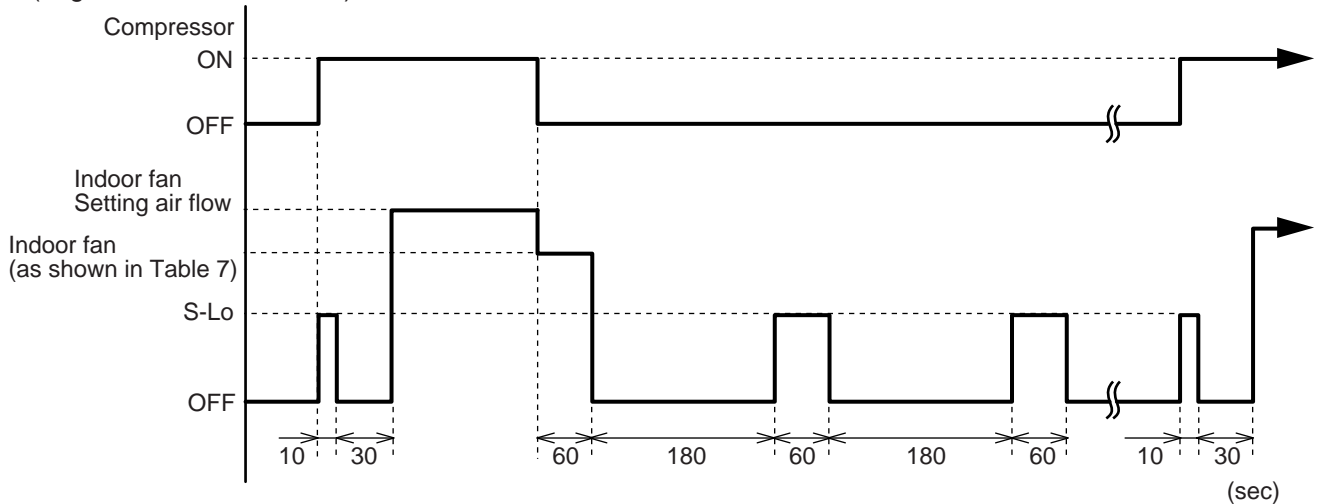

(Table 7 : Indoor fan speed)

	Dry		Cooling
	X zone	J zone	
AS*G07/09/12LMCA	680rpm	660rpm	680rpm
AS*G014LMCA	750rpm	730rpm	750rpm

8. INDOOR UNIT FAN (CONTROL FOR ENERGY SAVING (Cooling mode))

Switch the airflow at cooling mode, and the indoor fan motor will run as shown in Fig.7. It depends on the Function setting "Indoor unit fan control for energy saving".

9. DEFROST OPERATION

When the defrost operation starts, the indoor fan runs according to cool air prevention control for 20 seconds. And the fan is stopped if 20 seconds have passed.

When 60 seconds have passed after defrost operation is released, the fan runs according to cool air prevention control

6. OUTDOOR FAN CONTROL

1. Outdoor Fan Motor

Following table shows the type of the outdoor fan motor. The control method is different between AC motor and DC motor.

(Table 8 : Type of Motor)

	AC Motor	DC Motor
AO*G07/09/12/14LMCA		○

2. Fan Speed

(Table 9 : Outdoor fan speed)

	Zone ※	Cooling	Heating	Dry
AO*G07/09LMCA	Y	730/ 650/ 580/ 470	900/ 650/ 580/ 470	730/ 470
	Z	730/ 470/ 250		
	F	250/ 200/ 150		
	G	180/ 150		
AO*G12LMCA	Y	860/ 780/ 720/ 680/ 470	900/ 760/ 720/ 680/ 470	760/ 470
	Z	860/ 470/ 330		
	F	330/ 280/ 230		
	G	260/ 230/ 200		
AO*G14LMCA	Y	850/ 750/ 670/ 500	950/ 850/750/ 670/550/450	760/ 470
	Z	850/ 500/ 380		
	F	380/ 280/ 250		
	G	300/ 230/ 200		

※ Refer to Fig.8

(Fig.8 : Outside air temperature zone selection)

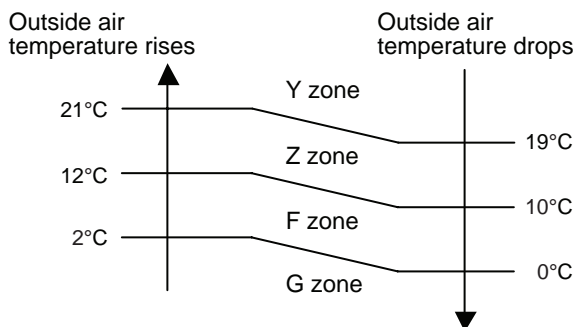

* The outdoor fan speed mentioned above depends on the compressor frequency.
(When the compressor frequency increases, the outdoor fan speed also changes to the higher speed. When the compressor frequency decreases, the outdoor fan speed also changes to the lower speed.)

* After the defrost control is operated on the heating mode, the fan speed keeps at the higher speed as table10 without relating to the compressor frequency.

(Table10 : Outdoor fan speed after the defrost)

AO*G07/09/12LMCA	900rpm
AO*G14LMCA	950rpm

7. LOUVER CONTROL

1. VERTICAL LOUVER CONTROL

(Function Range)

Each time the button is pressed, the air direction range will change as follow:

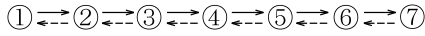

The Remote Controller's display does not change.

Fig.9 : Air Direction Range

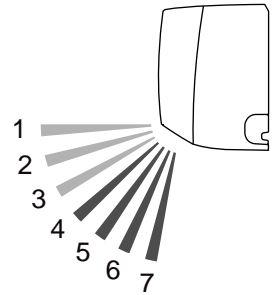

- If you set the angle to position 4.7 for more than 30 minutes in COOL or DRY mode, they automatically return to position 3.
In COOL or DRY mode, if the angle is set to position 4.7 for many hours, condensation may be formed, and the drips may wet your property.
- Use the air direction adjustments within the ranges shown above.
- The vertical airflow direction is set automatically as shown, in accordance with the type of operation selected.
 - Cooling / Dry mode : Horizontal flow ①
 - Heating mode : Downward flow ⑦
- During AUTO or Heating mode operation, for the first a few minutes after beginning operation, air-flow will be horizontal 1; the air direction cannot be adjusted during this period.
The air flow direction setting will temporarily become 1 when the temperature of the air -flow is low at the start of the Heating mode.

2. ADJUST THE RIGHT-LEFT LOUVERS

- Move the Right-Left louvers to adjust air flow in the direction you prefer.

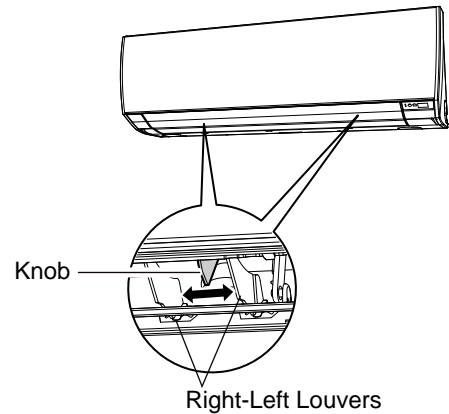

2. SWING OPERATION

To select Vertical Airflow Swing Operation

When the swing signal is received from the remote controller, the vertical louver starts to swing.

(Table11 : Swinging Range)

	Range
Cooling / Dry mode Fan mode (①~③)	① ⇔ ③
Heating mode Fan mode (④~⑦)	④ ⇔ ⑦

- The SWING operation may stop temporarily when the air conditioner's fan is not operating, or when operating at very low speeds.

To select Horizontal Airflow Swing Operation

(No function)

8. COMPRESSOR CONTROL

1. OPEARTION FREQUENCY RANGE

The operation frequency of the compressor is different based on the operation mode as shown in the Table 12.

(Table 12 : Compressor frequency range)

	Cooling / Dry		Heating	
	Minimum	Maximum	Minimum	Maximum
AO*G07/09LMCA	22rps	79rps	22rps	99rps
AO*G12LMCA	18rps	96rps	18rps	120rps
AO*G14LMCA	18rps	96rps	18rps	119rps

2. OPEARTION FREQUENCY CONTROL AT NORMAL START UP

The compressor frequency soon after the start-up is controlled as shown in the Fig.10

(Fig.10 : Compressor control at start-up)

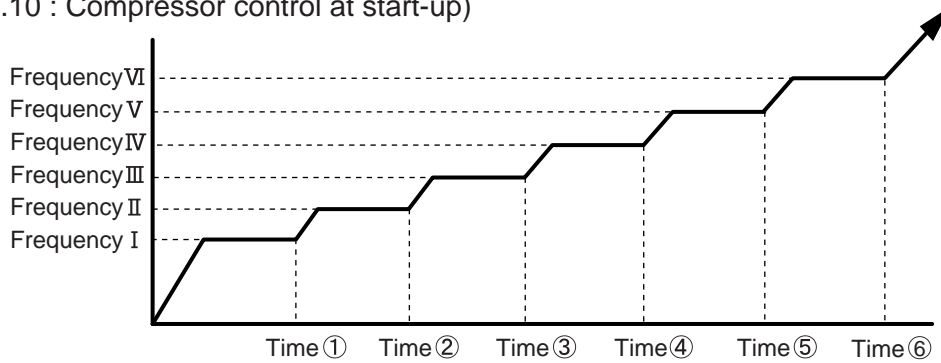

(Frequency)

	Frequency I	Frequency II	Frequency III	Frequency IV	Frequency V	Frequency VI
AO*G07/09LMCA	70rps	82rps	92rps	96rps	—	—
AO*G12/14LMCA	56rps	74rps	87rps	97rps	108rps	119rps

(Time)

	Time ①	Time ②	Time ③	Time ④	Time ⑤	Time ⑥
AO*G07/09LMCA	80sec	140sec	200sec	380sec	—	—
AO*G12LMCA	60sec	100sec	140sec	200sec	350sec	410sec
AO*G14LMCA	80sec	140sec	200sec	380sec	440sec	500sec

3. LIMITATION OF COMPRESSOR FREQUENCY BY OUTDOOR TEMPERATURE

The minimum compressor frequency is limited by outdoor temperature as shown in the Table13.

(Table13 : Limitation of Compressor Frequency)

[Cooling/ Dry]

	10°C		14°C		40°C	
	Under	Over	Under	Over	Under	Over
AO*G07/09LMCA	43rps	28rps	22rps	30rps		
AO*G12LMCA	45rps	27rps	18rps	30rps		
AO*G14LMCA	42rps	27rps	18rps	30rps		

[Heating]

	- 3°C		7°C		14°C		40°C	
	Under	Over	Under	Over	Under	Over	Under	Over
AO*G07/09LMCA	42rps	39rps	28rps	23rps	30rps			
AO*G12/14LMCA	36rps	27rps	27rps	18rps	30rps			

9. TIMER OPEARTION CONTROL

9-1 WIRELESS REMOTE CONTROLLER

The Table 14 shows the available timer setting based on the product model.

(Table 14 : Timer Setting)

	ON TIMER / OFF TIMER	PROGRAM TIMER	SLEEP TIMER
AS*G07/09/12/14LMCA	○	○	○

1. OPEARTION FREQUENCY RANGE

- OFF timer : When the clock reaches the set time, the air conditioner will be turned off.

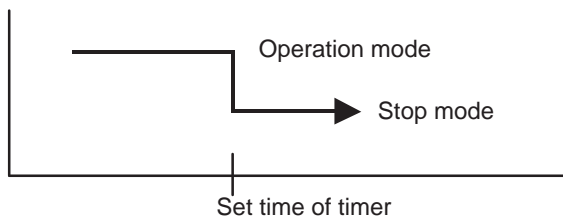

- ON timer : When the clock reaches the set time, the air conditioner will be turned on.

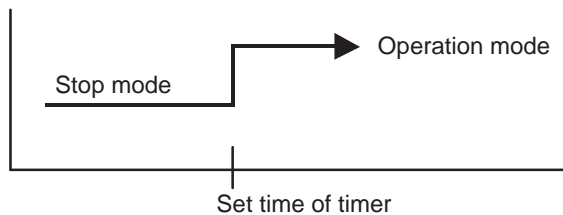

2. PROGRAM TIMER

- The program timer allows the OFF timer and ON timer to be used in combination one time.

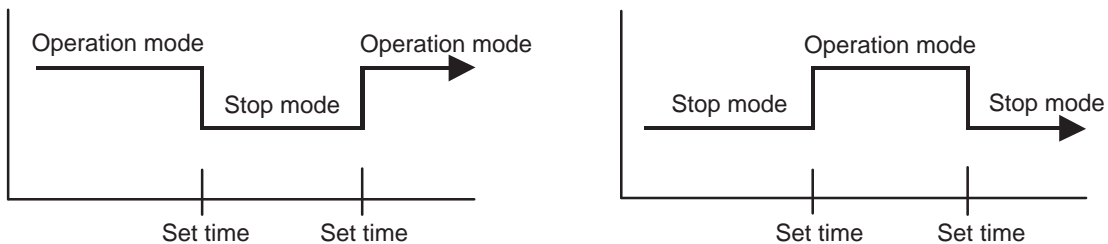

- Operation will start from the timer setting (either OFF timer or ON timer) whichever is closest to the clock's current timer setting.
The order of operations is indicated by the arrow in the remote control unit's display.
- SLEEP timer operation cannot be combined with ON timer operation.

3. SLEEP TIMER

If the sleep is set, the room temperature is monitored and the operation is stopped automatically. If the operation mode or the set temperature is change after the sleep timer is set, the operation is continued according to the changed setting of the sleep timer from that time ON.

In the cooling operation mode

When the sleep timer is set, the setting temperature is increased 1°C. It increases the setting temperature another 1°C after 1 hour. After that, the setting temperature is not changed and the operation is stopped at the time of timer setting.

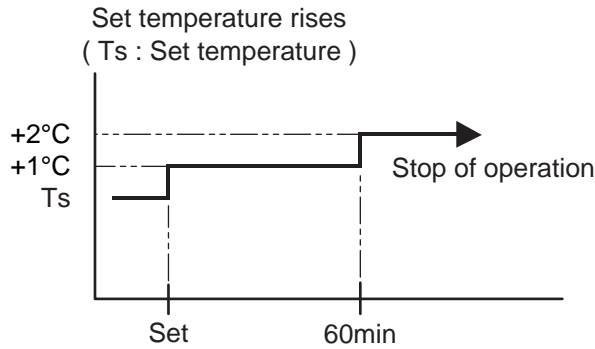

In the heating operation mode

When the sleep timer is set, the setting temperature is decreased 1°C. It decreases the setting temperature another 1°C every 30 minutes. Upon lowering 4°C, the setting temperature is not changed and the operation stops at the time of timer setting.

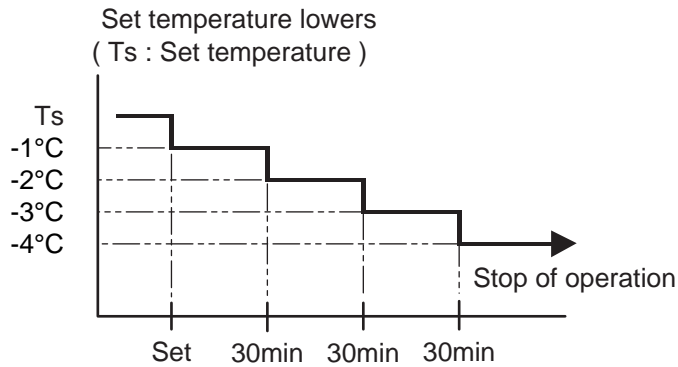

9-2 WIRED REMOTE CONTROLLER (OPTION)

The Table15 shows the available timer setting based on the product model.

(Table15 : Timer Setting)

	ON TIMER / OFF TIMER	WEEKLY TIMER	TEMPERATURE SET BACK TIMER
AS*G07/09/12/14LMCA	○	○	○

1. ON TIMER / OFF TIMER

Same to 9-1 1.ON TIMER / OFF TIMER and shown in those.

2. WEEKLY TIMER

This timer function can set operation times of the each day of the week.

All days can be set together, the weekly timer can be used to repeat the timer setting for all of the days.

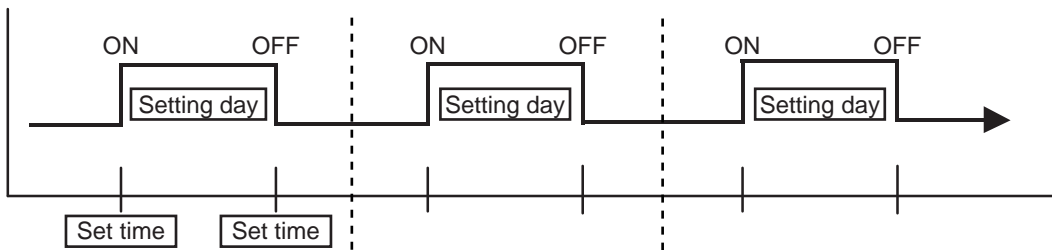

3. TEMPERATURE SET BACK TIMER

This timer function can change setting temperature of setting operation times of the each day of the week.

This can be together with other timer setting.

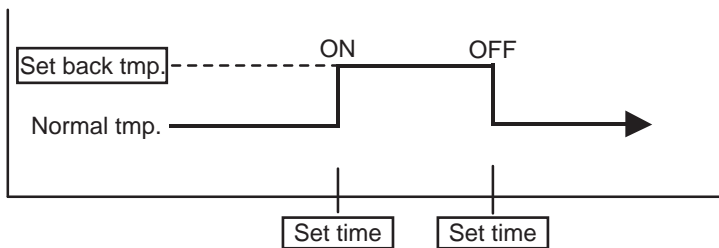

10. ELECTRONIC EXPANSION VALVE CONTROL

The most proper opening of the electronic expansion valve is calculated and controlled under the present operating condition based on the Table16.

The compressor frequency, the detected temperature by the discharge temperature sensor, the indoor heat exchanger sensor, the outdoor heat exchanger sensor, and the outdoor temperature sensor.

(Table16 : The pulse range of the electronic expansion valve control)

	Operation mode	Pulse range
AO*G07/09LMCA	Cooling / Dry mode	Between 32 to 480 pulses.
AO*G12/14LMCA	Heating mode	

- * The expansion valve is set at 480 pulses 110seconds after the compressor had stopped.
- * Initialization will start after 24 hours pass from the last initialization, and the compressor stops
- * At the time of supplying the power to the outdoor unit, the initialization of the electronic expansion valve is operated (528 pulses are input to the closing direction).

11. TEST OPERATION CONTROL

[Operation method]

The outdoor unit, may not operate, depending on the room temperature.

In this case, keep on pressing the MANUAL AUTO button of the indoor unit for more than 10 seconds.

The Operation lamp and Timer lamp will begin to flash simultaneously during cooling test run.

Then, heating test run will begin in about 3 minutes when HEAT is selected by the remote control operation.

(When the air conditioner is running by pressing the test run button, the Operation lamp and Timer lamp will simultaneously flash slowly.)

[Release]

Perform the test operation for 60 minutes.

Pressing the MANUAL AUTO button of the indoor unit for more than 3 seconds.

[Using the Wired remote control (Option)]

If the Operation lamp is on, press the START/STOP button to turn it off.

Press the MODE and the FAN buttons at the same time for more than two seconds to start the test operation.

The operation lamp will light up and "o1" will be displayed on the set temperature display.

[Release]

Perform the test operation for 60 minutes.

Pressing the START/STOP button will stop the test operation.

12. PREVENT TO RESTART FOR 3 MINUTES (3 MINUTES ST)

The compressor won't enter operation status for 2 minutes and 20 seconds after the compressor is stopped, even if any operation is given.

13. FOUR-WAY VALVE EXTENSION SELECT

At the time when the air conditioner is switched from the cooling mode to heating mode, the compressor is stopped, and the four-way valve is switched in 2 minutes and 20 seconds later after the compressor stopped.

14. AUTO RESTART

When the power was interrupted by a power failure, etc. during operation, the operation contents at that time are memorized and when power is recovered, operation is automatically started with the memorized operation contents.

When the power is interrupted and recovered during timer operation, since the timer operation time is shifted by the time the power was interrupted, an alarm is given by blinking (7 sec ON/2 sec OFF) the indoor unit body timer lamp.

[Operation contents memorized when the power is interrupted]

- Operation mode
- Set temperature
- Set air flow
- Timer mode and set time (set by wireless remote controller)
- Set air flow Direction
- Swing
- ECONOMY operation
- 10°C HEAT operation
- Outdoor low noise operation

15. MANUAL AUTO OPERATION (Indoor unit body operation)

When the remote control is lost or battery power dissipated, this function will work without the remote control. When MANUAL AUTO button is set more than 3seconds and less than 10seconds, MANUAL AUTO OPERATION will be started as shown in Table17. To stop operation, press the MANUAL AUTO button for 3seconds.

(Table17 : MANUAL AUTO OPERATION)

	Manual auto operation
OPERATION MODE	Auto changeover
FAN CONT. MODE	Auto
TIMER MODE	Continuous (No timer setting available)
SETTING TEMP.	24°C
SETTING LOUVER	Standard
SWING	OFF
ECONOMY	OFF

16. FORCED COOLING OPERATION (TEST OPERATION)

When FORCED COOLING OPERATION is set, the operation is controlled as shown in Table18.

(Table18 : FORCED COOLING OPERATION)

	Forced cooling operation
OPERATION MODE	Cooling
FAN CONT. MODE	Hi
TIMER MODE	-
SETTING TEMP.	Room Temp is not controlled
SETTING LOUVER	Horizontal (It is changed follow as setting of remote controller)
SWING	OFF
ECONOMY	-

- Forced cooling operation is started when press MANUAL AUTO button for 10 seconds or more.
- During the forced cooling operation, it operates regardless of room temperature sensor.
- Operation LED and timer LED blink at the same time during the forced cooling operation.
They blink for 1 second ON and 1 second OFF on both operation LED and timer LED (same as test operation).
- Forced cooling operation is released after 60 minutes of starting operation or pressing MANUAL AUTO button for 3 seconds.

17. COMPRESSOR PREHEATING

When the outdoor heat exchanger temperature is lower than 5°C and the all operation has been stopped for 30 minutes, power is applied to the compressor and the compressor is heated.

(By heating the compressor, warm air is quickly discharged when operation is started.)

When operation was started and when the outdoor temperature rises to 7°C or greater, preheating is ended.

18. 10°C HEAT OPERATION

10°C HEAT operation performs as below when pressing 10°C HEAT button or Weekly timer setting on the remote controller.

(Table 19 : 10°C HEAT operation)

Mode	Heating
Setting temperature	10°C
Fan mode	Auto
LED display	Economy
Defrost operation	Operate as normal

19. ECONOMY OPERATION

The ECONOMY operation functions by pressing ECONOMY button on the remote controller.

At the maximum output, ECONOMY Operation is approximately 70% of normal air conditioner operation for cooling and heating.

The ECONOMY operation is almost the same operation as below settings.

(Table 20)

Mode	Cooling/ Dry	Heating
Target temperature	Setting temp.+1°C	Setting temp.-1°C

20. OUTDOOR UNIT LOW NOISE OPERATION

The OUTDOOR UNIT LOW NOISE Operation functions by pressing OUTDOOR UNIT LOW NOISE button on the remote controller.

This operation stops the PFC control, and changes the Current release operation/release value.

OUTDOOR UNIT LOW NOISE Operation mode can be used during cooling, heating and automatic operation.

It can not be used in Fan and Dry mode

(Table 21)

	Control / Release
Current release operation/release value	3.5A / 3.0A

21. POWERFUL OPERATION

The POWERFUL OPERATION functions by pressing POWERFUL button on the remote controller. The indoor unit & outdoor unit will operate at maximum power as shown in Table22.

(Table22)

	Powerful operation
COMPRESSOR FREQUENCY	Maximum
FAN CONT. MODE	Powerful
SETTING LOUVER	Cooling/ Dry : 3, Heating : 6

Release Condition is as follows.

[Cooling / Dry]

- Room temperature \leq Setting temperature - 1°C or Operation time has passed 20 minutes.

[Heating]

- Room temperature \geq Setting temperature +2°C and Operation time has passed 20 minutes.

22. DEFROST OPERATION CONTROL

1. CONDITION OF STARTING THE DEFROST OPERATION

The defrost operation starts as shown in the following Table 23.

(Table 23 : Condition of starting Defrost Operation)

Normal defrost	Compressor integrating operation time	
	Less than 25 minutes	More than 25 minutes
	Does not operate	Outdoor heat exchanger temp. $\leq -17^{\circ}\text{C}$ (at outside air temp. $\geq -10^{\circ}\text{C}$) ----- Outdoor heat exchanger temp. \leq Outside air temp. - 7°C or Outdoor heat exchanger temp. $\leq -20^{\circ}\text{C}$ (at outside air temp. $< -10^{\circ}\text{C}$)

Integrating defrost	Compressor integrating operation time		
	More than 240 minutes (For continuous operation)	More than 213 minutes (For continuous operation)	Less than 10 minutes* (For intermittent operation)
	Outdoor heat exchanger temperature below -3°C	Outdoor heat exchanger temperature below -5°C	OFF count of the compressor 40 times

*If the compressor continuous operation time is less than 10 minutes, the OFF number of the compressor is counted.
If any defrost operated, the compressor OFF count is cleared.

2. CONDITION OF THE DEFROST OPERATION COMPLETION

Defrost operation is released when the conditions become as shown in Table 24.

(Table 24 : Defrost Release Condition)

Release Condition
Outdoor heat exchanger temperature sensor value is higher than $+16^{\circ}\text{C}$ or Compressor operation time has passed 15 minutes.

3. Defrost Flow Chart

The defrosting shall proceed by the integrating operation time, outdoor temperature and outdoor heat exchanger temperature as follows.

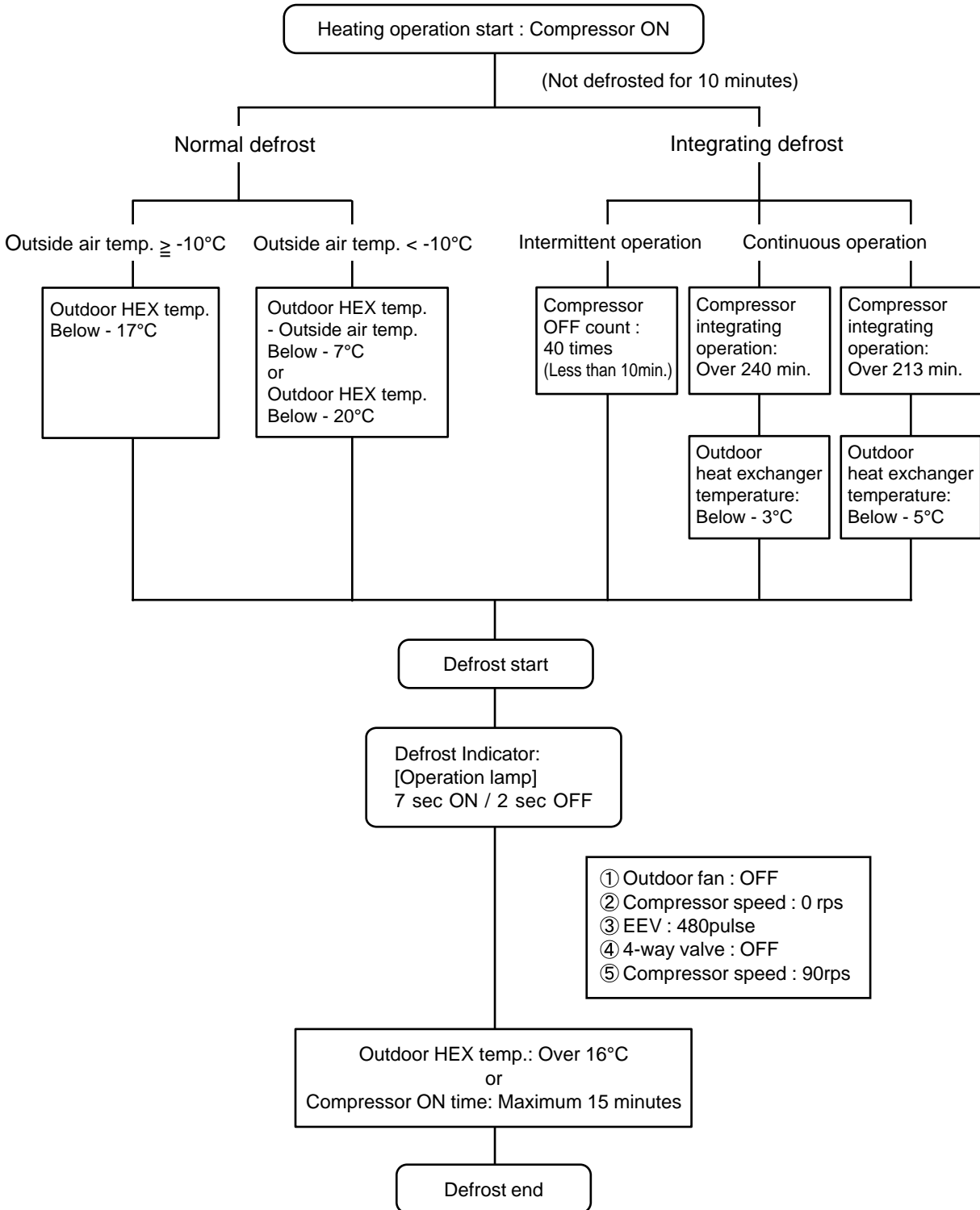

23. OFF DEFROST OPERATION CONTROL

When operation stops in the [Heating operation] mode, if frost is adhered to the outdoor unit heat exchanger, the defrost operation will proceed automatically. In this time, if indoor unit operation lamp flashes slowly (7 sec ON / 2 sec OFF), the outdoor unit will allow the heat exchanger to defrost, and then stop.

1. OFF DEFROST OPERATION CONDITION

In heating operation, the outdoor heat exchanger temperature is less than -4°C , compressor continuous operation more than 10 minutes, and compressor operation integrating time lasts for more than 30 minutes.

2. OFF DEFROST END CONDITION

Release Condition
Outdoor heat exchanger temperature sensor value is higher than 16°C or Compressor operation time has passed 15 minutes.

OFF Defrost Flow Chart

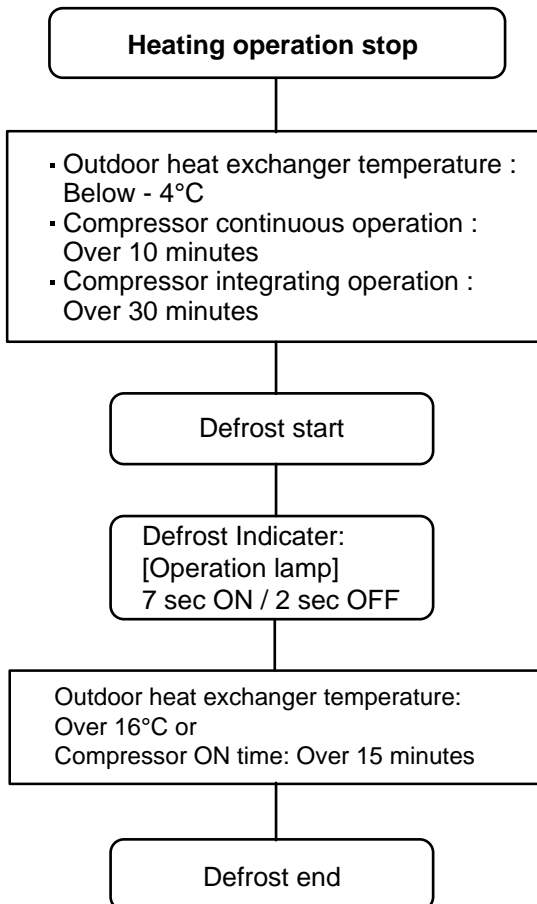

24. VARIOUS PROTECTIONS

1. DISCHARGE GAS TEMPERATURE OVERRISE PREVENION CONTROL

The discharge gas thermosensor (discharge thermistor : Outdoor side) will detect discharge gas temperature. When the discharge temperature becomes higher than Temperature I, the compressor frequency is decreased 20rps, and it continues to decrease the frequency for 20rps every 120 seconds until the temperature becomes lower than Temperature I.

When the discharge temperature becomes lower than Temperature II, the protection control of the compressor frequency will be released.

When the discharge temperature becomes higher than Temperature III, the compressor is stopped and the indoor unit LED starts blinking.

(Table 25 : Discharge temperature over rise prevention control / Release temperature)

	Temperature I	Temperature II	Temperature III
AO*G07/09/12/14LMCA	104°C	101°C	110°C

2. CURRENT RELEASE CONTROL

The compressor frequency is controlled so that the outdoor unit input current does not exceed the current limit value that was set up with the outdoor temperature.

The compressor frequency returns to the designated frequency of the indoor unit at the time when the frequency becomes lower than the release value.

(Table 26 : Current release operation value / Release value)

[Heating]

AO*G07/09LMCA	
OT (Control / Release)	
17°C	5.5A / 5.0A
10°C	6.0A / 5.5A
5°C	7.0A / 6.5A
	7.0A / 6.5A

OT : Outdoor Temperature

[Heating]

AO*G12LMCA	
OT (Control / Release)	
17°C	5.5A / 5.0A
10°C	7.0A / 6.5A
5°C	8.0A / 7.5A
	8.5A / 8.0A

OT : Outdoor Temperature

[Heating]

AO*G14LMCA	
OT (Control / Release)	
17°C	7.0A / 6.5A
10°C	9.0A / 8.5
5°C	10.0A / 9.5A
	10.0A / 9.5A

OT : Outdoor Temperature

[Cooling]

AO*G07/09LMCA	
OT (Control / Release)	
46°C	3.5A / 3.0A
40°C	4.0A / 3.5A
	5.5A / 5.0A

OT : Outdoor Temperature

[Cooling]

AO*G12LMCA	
OT (Control / Release)	
46°C	4.0A / 3.5A
40°C	5.0A / 4.5A
	6.0A / 5.5A

OT : Outdoor Temperature

[Cooling]

AO*G14LMCA	
OT (Control / Release)	
46°C	4.5A / 4.0A
40°C	6.0A / 5.5A
	8.5A / 8.0A

OT : Outdoor Temperature

3. ANTIFREEZING CONTROL (Cooling and Dry mode)

The compressor frequency is decrease on cooling & dry mode when the indoor heat exchanger temperature sensor detects the temperature lower than Temperature I. Then, the anti-freezing control is released when it becomes higher than Temperature II.

(Table 27 : Anti-freezing Protection Operation / Release Temperature)

Outdoor temperature	Temperature I	Temperature II
Over than 10°C *1 or 12°C *2	4°C	7°C
Less than 10°C *1 or 12°C *2		13°C

*1. When the temperature rises.

*2. When the temperature drops.

4. COOLING PRESSURE OVERRISE PROTECTION

When the outdoor unit heat exchange sensor temperature rises to 67°C or greater, the compressor and the outdoor fan motor are stopped and trouble display is performed.

5. HIGH TEMPERATURE RELEASE CONTROL (HEATING MODE)

On heating mode, the compressor frequency is controlled as following based on the detection value of the indoor heat exchanger temperature sensor.

[Control System]

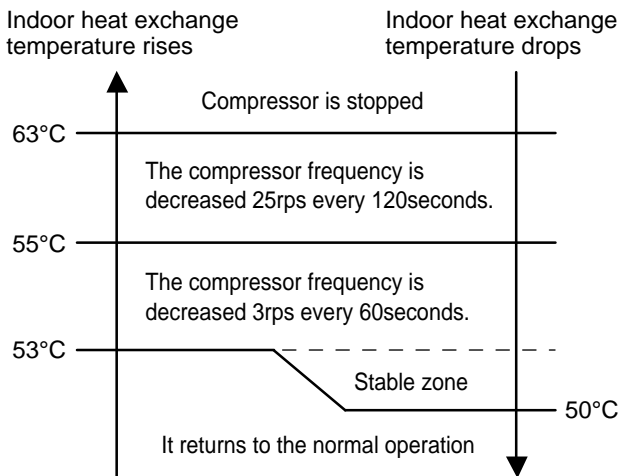

WALL MOUNTED type INVERTER

2 . TROUBLE SHOOTING

2. TROUBLESHOOTING

2-1 ERROR DISPLAY

2-1-1 INDOOR UNIT AND WIRED REMOTE CONTROLLER DISPLAY

Please refer the flashing pattern as follows.

Indoor Unit : AS*G07/ 09/ 12/ 14 LMCA

The OPERATION, TIMER and ECONOMY indicators operate as follows according to the error contents.

Error Contents	Indoor Unit Display			Wired Remote Controller Display	Trouble shooting
	OPERATION [I] (Green)	TIMER [⌚] (Orange)	ECONOMY [⌚] (Green)		
Serial communication error	1 times	1 times	Continuous	11	1
Wired remote controller communication error	1 times	2 times	Continuous	12	2
Indoor unit model information error EEPROM access abnormal	3 times	2 times	Continuous	32	3
Manual auto switch error	3 times	5 times	Continuous	35	4
Indoor room thermistor error	4 times	1 times	Continuous	41	5
Indoor heat Ex. thermistor error	4 times	2 times	Continuous	42	6
Indoor unit fan motor error	5 times	1 times	Continuous	51	7
Outdoor unit main PCB error	6 times	2 times	Continuous	62	8
PFC circuit error	6 times	4 times	Continuous	64	9
IPM error	6 times	5 times	Continuous	65	10
Discharge thermistor error	7 times	1 times	Continuous	71	11
Heat Ex. liquid outlet thermistor error	7 times	3 times	Continuous	73	12
Outdoor thermistor error	7 times	4 times	Continuous	74	13
Current sensor error	8 times	4 times	Continuous	84	14
Over current error	9 times	4 times	Continuous	94	15
Compressor control error	9 times	5 times	Continuous	95	16
Outdoor unit fan motor error	9 times	7 times	Continuous	97	17
4 Way valve error	9 times	9 times	Continuous	99	18
Discharge temp. error	10 times	1 times	Continuous	A1	19

2-1-2 WIRED REMOTE CONTROLLER DISPLAY (OPTION)

1. SELF - DIAGNOSIS

When "Er" in Temperature Display is displayed, inspection of the air conditioning system is necessary. Please consult authorized service personnel.

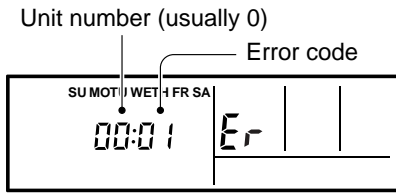

ex. Self-diagnosis check

2. ERROR CODE HISTORY DISPLAY

Up to 16 memorized error codes may be displayed for the indoor unit connected to the remote controller.

1. Stop the air conditioner operation.

2. Press the SET TEMPERATURE buttons ∇ , \blacktriangle simultaneously for 3 seconds or more to start the self-diagnosis.

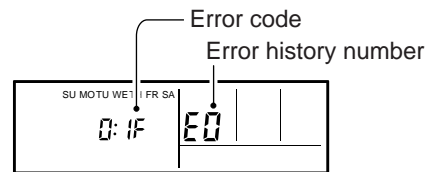
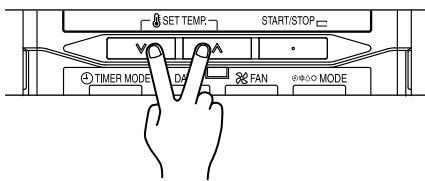

3. Press the SET TEMPERATURE button to select the error history number.

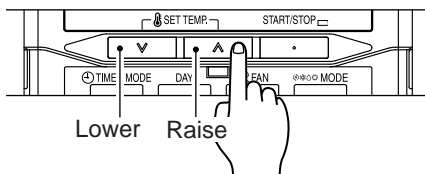

Lower Raise

0 ↔ 1 ↔ 2 ↔ 3 ↔ 4 ↔ 5 ↔ 6 ↔ 7
F ↔ E ↔ d ↔ c ↔ b ↔ A ↔ 9 ↔ 8

4. Press the SET TEMPERATURE buttons ∇ , \blacktriangle simultaneously for 3 seconds or more or there is no key input for 60 seconds to stop the display.

2-2 TROUBLE SHOOTING WITH ERROR CODE

Trouble shooting 1-1
OUTDOOR UNIT Error Method:
Serial communication error
(Serial Reverse Transfer Error)

Indicate or Display:

Refer to error code table.

Detective Actuators:

Outdoor unit Main PCB
 Outdoor unit fan motor

Detective details:

When the indoor unit cannot receive the serial signal from Outdoor unit more than 2minutes after power ON, or the indoor unit cannot receive the serial signal more than 15seconds during normal operation.

Forecast of Cause:

1. Connection failure 2. External cause 3. Main PCB failure 4. Outdoor unit fan motor failure

Check Point 1-1 : Reset the power and operate

· Does Error indication show again?

NO

YES

Check Point 2 : Check Connection

· Check any loose or removed connection line of Indoor unit and Outdoor unit.
 >> **If there is an abnormal condition, correct it by referring to Installation Manual or Data & Technical Manual.**

Check Point 1-2: Check external cause such as noise

· Check the complete insulation of the grounding.
 · Check if there is any equipment that causes harmonic wave near the power cable (Neon light bulb or any electronic equipment which causes harmonic wave).

OK

Check Point 3 : Check the voltage of power supply

· Check the voltage of power supply
 >> **Check if AC207V (AC230V -10%) - 253V (AC230V +10%) appears at Outdoor Unit Terminal L - N.**

AC

OK

Check Point 4 : Check Serial Signal (Reverse Transfer Signal)

· Check Serial Signal (Reverse Transfer Signal)
 >> **Check if Indicated value swings between AC90V and AC270V at Outdoor Unit Terminal 1 - 3.**
 >> **If it is abnormal, Check Outdoor unit fan motor. (PARTS INFORMATION 5)**
 >> **If Outdoor fan motor is abnormal, replace Outdoor unit fan motor and Main PCB.**
 >> **If Outdoor fan motor is normal, replace Main PCB.**

AC

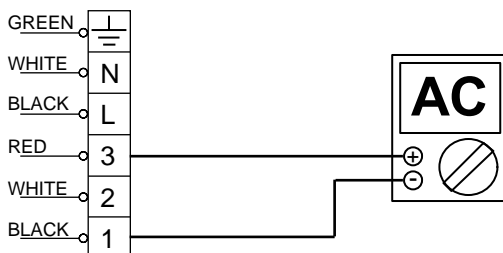

Trouble shooting 1-2 INDOOR UNIT Error Method: Serial communication error (Serial Forward Transfer Error)	Indicate or Display: Refer to error code table.
--	--

Detective Actuators: Indoor unit Controller PCB Indoor unit Fan motor Outdoor unit Main PCB	Detective details: When the outdoor unit cannot receive the serial signal from Indoor unit more than 10seconds.
---	---

Forecast of Cause: 1. Connection failure 2. External cause 3. Controller PCB failure 4. Indoor unit fan motor failure 5. Outdoor unit Main PCB
--

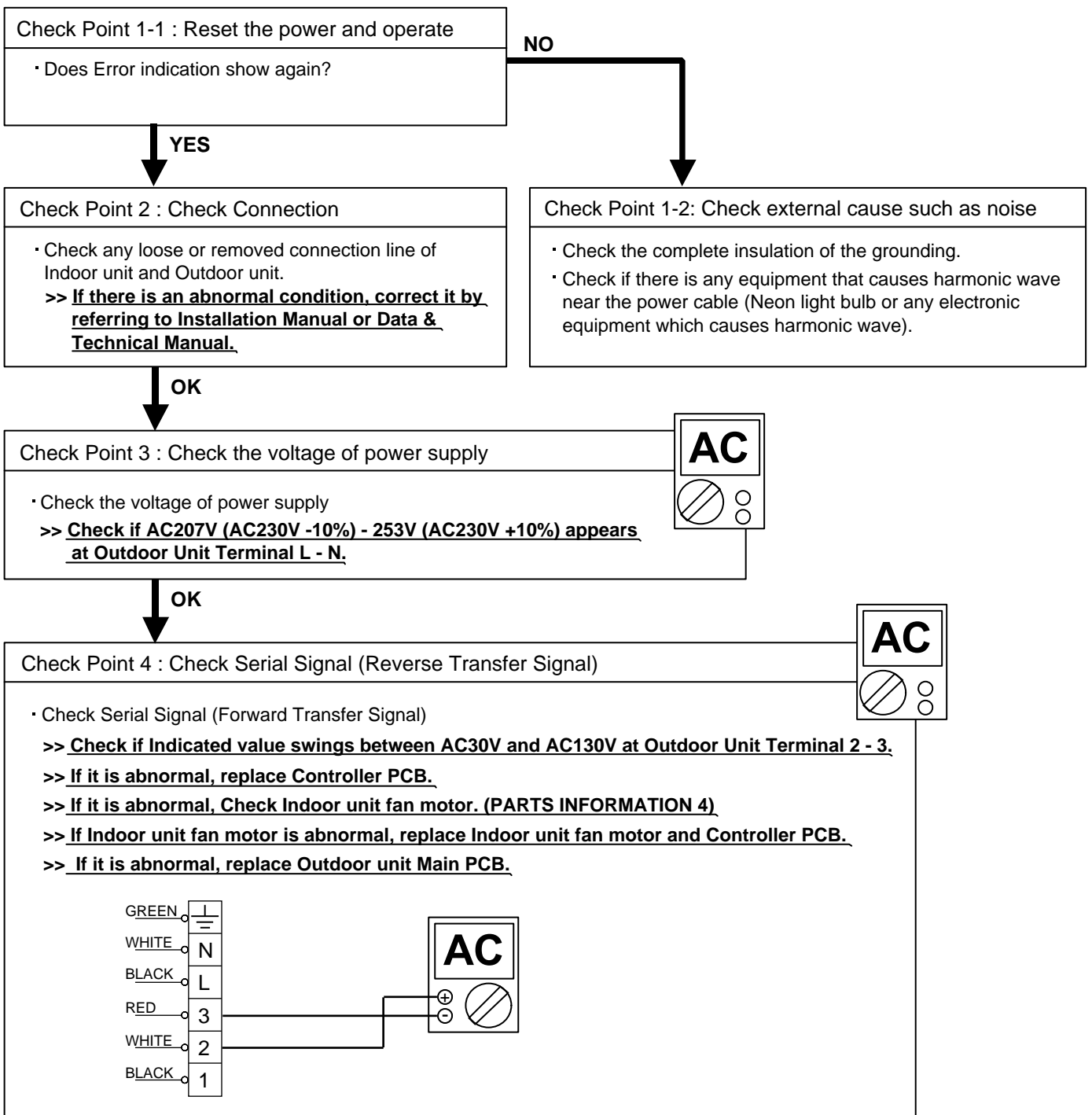

<p>Trouble shooting 2 <u>INDOOR UNIT Error Method:</u> Remote controller communication error</p>	<p><u>Indicate or Display:</u> Refer to error code table.</p>
---	--

<p><u>Detective Actuators:</u> Indoor unit Controller PCB Wired remote control</p>	<p><u>Detective details:</u> When the indoor unit cannot receive the signal from Wired Remote Control more than 1minute during normal operation.</p>
---	--

<p><u>Forecast of Cause:</u> 1. Terminal connection abnormal 2. Wired remote control failure 3. Controller PCB failure</p>
--

<p>Check Point 1 : Check the connection of terminal</p>
<p><u>After turning off the power, check & correct the followings.</u> · Check the connection of terminal between remote control and Indoor unit, and check if there is a disconnection of the cable.</p>



<p>Check Point 2 : Check Remote Control and Controller PCB</p>	
<p>· Check Voltage at CNC01 (terminal 1-3) of UTY-XCBXZ2 (Communication kit). (Power supply to Remote Control) >> If it is DC13V, Remote Control is failure. (Controller PCB is normal) >> Replace Remote Control >> If it is DC 0V, Controller PCB is failure. (Check Remote Control once again) >> Replace Controller PCB ▶ <u>Upon correcting the removed connector or mis-wiring, reset the power.</u></p>	

Trouble shooting 3 <u>INDOOR UNIT Error Method:</u> Indoor unit main PCB error	<u>Indicate or Display:</u> Refer to error code table.
---	---

<u>Detective Actuators:</u> Indoor unit Controller PCB	<u>Detective details:</u> When power is on and there is some below case. 1. When model information of EEPROM is incorrect. 2. When the access to EEPROM failed.
--	---

<u>Forecast of Cause:</u> 1. External cause 2. Defective connection of electric components 3. Controller PCB failure
--

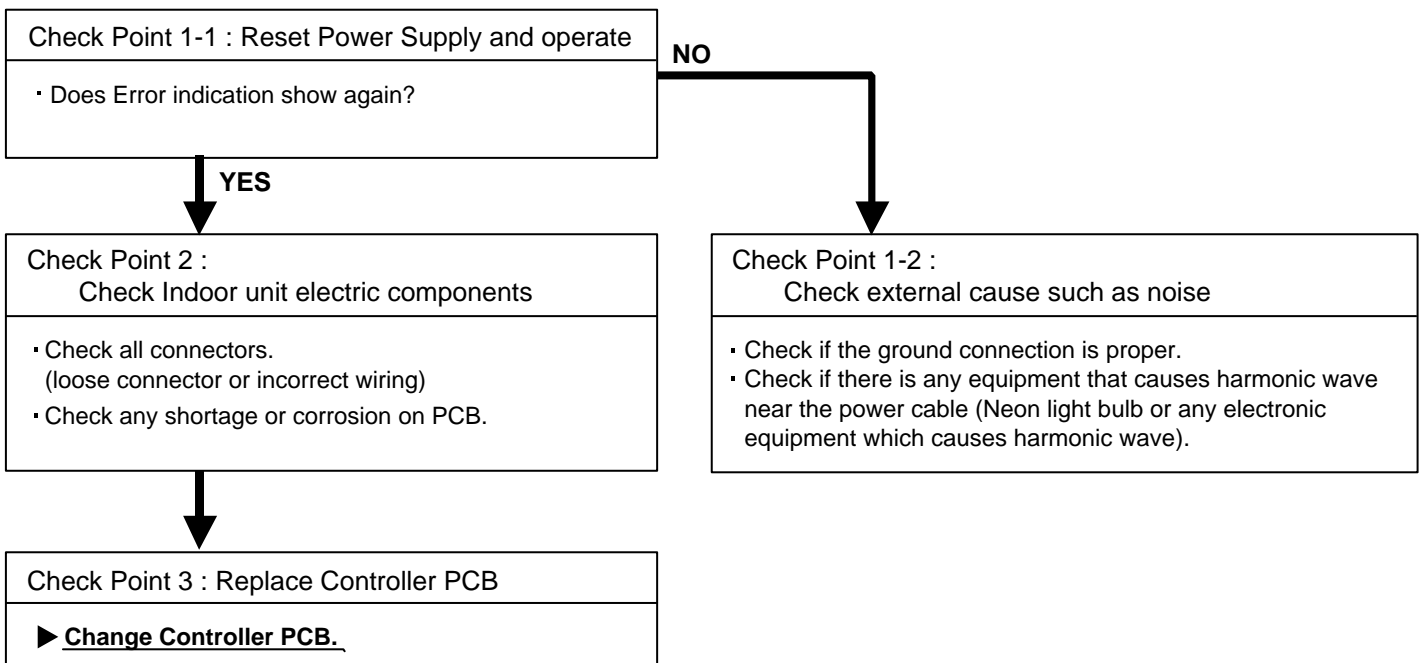

Note : EEPROM

EEPROM(Electronically Erasable and Programmable Read Only Memory) is a non-volatile memory which keeps memorized information even if power is turned off. It can change the contents electronically. To change the contents, it uses higher voltage than normal, and it can not change a partial contents. (Rewriting shall be done upon erasing the all contents.) There is a limit in a number of rewriting.

<p>Trouble shooting 4 <u>INDOOR UNIT Error Method:</u> Manual auto switch error</p>	<p><u>Indicate or Display:</u></p> <p>Refer to error code table.</p>
--	--

<p><u>Detective Actuators:</u></p> <p>Indoor unit Controller PCB Indicator PCB Manual auto switch</p>	<p><u>Detective details:</u></p> <p>When the Manual Auto Switch becomes ON for consecutive 60 or more seconds.</p>
--	---

<p><u>Forecast of Cause :</u></p> <p>1. Manual auto switch failure 2.Controller PCB and Indicator PCB failure</p>

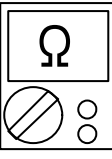
<p>Check Point 1 : Check the Manual auto switch</p> <ul style="list-style-type: none"> • Check if Manual auto switch is kept pressed. • Check ON/OFF switching operation by using a meter. <p>>><u>If Manual Auto Switch is disabled (on/off switching), replace it.</u></p>	
--	--



<p>Check Point 2 : Replace Controller PCB</p>
<p>▶ <u>If Check Point 1 do not improve the symptom, change Controller PCB and Indicator PCB.</u></p>

Trouble shooting 5 INDOOR UNIT Error Method: Room temperature sensor error	Indicate or Display: Refer to error code table.
---	--

Detective Actuators: Indoor unit Controller PCB Room temperature thermistor	Detective details: When Room Temperature Thermistor open or short-circuit is detected.
--	--

Forecast of Cause :
1. Connector connection failure 2. Thermistor failure 3. Controller PCB failure

Check Point 1 : Check connection of Connector

- Check if connector is removed.
- Check erroneous connection.
- Check if thermistor cable is open.

>>Upon correcting the removed connector or mis-wiring, reset the power.



Check Point 2 : Remove connector and check Thermistor resistance value

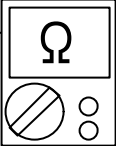

Thermistor Characteristics (Approx. value)

Temperature	-10°C	-5°C	0°C	5°C	10°C	15°C	20°C	25°C
Resistance Value (kΩ)	55.46	42.36	32.67	25.39	19.91	15.71	12.5	10.0

Temperature	30°C	35°C	40°C	45°C
Resistance Value (kΩ)	8.051	6.52	5.316	4.354

► If Thermistor is either open or shorted, replace it and reset the power.



Check Point 3 : Check voltage of Controller PCB (DC5.0V)

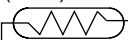
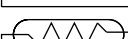
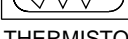
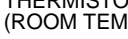

Make sure circuit diagram of indoor unit and check terminal voltage at Thermistor (DC5.0V)

THERMISTOR (PIPE)			
	BLACK	1	1
	BLACK	2	2
	BLACK	3	3
	BLACK	4	4
THERMISTOR (ROOM TEMP.)			

CN4

► If the voltage does not appear, replace Controller PCB.

Trouble shooting 6 INDOOR UNIT Error Method: Indoor unit Heat Ex. sensor error	Indicate or Display: Refer to error code table.
---	--

Detective Actuators: Indoor unit Controller PCB Heat Ex. temperature thermistor	Detective details: When Heat Ex. Temperature Thermistor open or short-circuit is detected.
--	--

Forecast of Cause : 1. Connector connection failure 2. Thermistor failure 3. Controller PCB failure

Check Point 1 : Check connection of Connector
<ul style="list-style-type: none"> • Check if connector is removed. • Check erroneous connection. • Check if thermistor cable is open. <p>>>Upon correcting the removed connector or mis-wiring, reset the power.</p>



Check Point 2 : Remove connector and check Thermistor resistance value							
Thermistor Characteristics (Approx. value)							
Temperature	-10°C	-5°C	0°C	5°C	10°C	20°C	
Resistance Value (kΩ)	295.1	223.3	170.7	131.4	102.1	62.9	
Temperature	30°C	40°C	50°C	60°C	63°C		
Resistance Value (kΩ)	39.78	25.8	17.11	11.6	10.36		
► If Thermistor is either open or shorted, replace it and reset the power.							



Check Point 3 : Check voltage of Controller PCB (DC5.0V)		
Make sure circuit diagram of indoor unit and check terminal voltage at Thermistor (DC5.0V)		
► If the voltage does not appear, replace Controller PCB.		

Trouble shooting 7 <u>INDOOR UNIT Error Method:</u> Indoor unit fan motor error	<u>Indicate or Display:</u> Refer to error code table.
---	--

<u>Detective Actuators:</u> Indoor unit Controller PCB Indoor unit Fan motor	<u>Detective details:</u> When the condition that actual frequency of Indoor Fan is below 1/3 of target frequency is continued more than 56 seconds.
---	--

<u>Forecast of Cause:</u> 1. Fan rotation failure 2. Fan motor winding open 3. Motor protection by surrounding temperature rise 4. Control PCB failure 5. Indoor unit fan motor failure
--

Check Point 1 : Check rotation of Fan
<ul style="list-style-type: none"> · Rotate the fan by hand when operation is off. (Check if fan is caught, dropped off or locked motor) >><u>If Fan or Bearing is abnormal, replace it.</u>



Check Point 2 : Check ambient temp. around motor
<ul style="list-style-type: none"> · Check excessively high temperature around the motor. (If there is any surrounding equipment that causes heat) >><u>Upon the temperature coming down, restart operation.</u>



Check Point 3 : Check Indoor unit fan motor
<ul style="list-style-type: none"> · Check Indoor unit fan motor. (PARTS INFORMATION 4) >><u>If Indoor unit fan motor is abnormal, replace Indoor unit fan motor.</u>



Check Point 4 : Replace Controller PCB
▶ <u>If Check Point 1- 3 do not improve the symptom, replace Controller PCB.</u>

<p>Trouble shooting 8 <u>OUTDOOR UNIT Error Method:</u> Outdoor unit main PCB error</p>	<p><u>Indicate or Display:</u> Refer to error code table.</p>
---	---

<p><u>Detective Actuators:</u> Outdoor unit Main PCB</p>	<p><u>Detective details:</u> Access to EEPROM failed due to some cause after outdoor unit started.</p>
---	---

<p><u>Forecast of Cause:</u> 1. External cause (Noise, temporary open, voltage drop) 2. Main PCB failure</p>

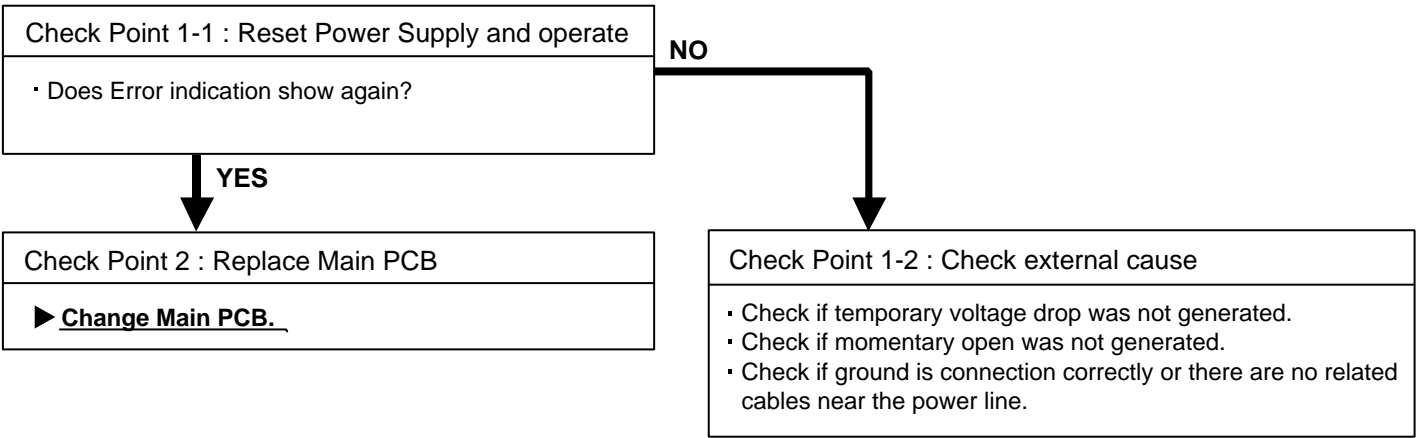

Trouble shooting 9 <u>OUTDOOR UNIT Error Method:</u> PFC circuit error	<u>Indicate or Display:</u> Refer to error code table.
---	---

<u>Detective Actuators:</u> Outdoor unit Main PCB	<u>Detective details:</u> When inverter output DC voltage is higher than 415V for over 3 seconds, the compressor stops. If the same operation is repeated 5 times, the compressor stops permanently.
---	---

<u>Forecast of Cause :</u> 1. External cause 2. Connector connection failure 3. Main PCB failure
--

Check Point 1 : Check external cause at Indoor and Outdoor (Voltage drop or Noise)
<ul style="list-style-type: none"> • Instant drop : Check if there is a large load electric apparatus in the same circuit. • Momentary power failure : Check if there is a defective contact or leak current in the power supply circuit. • Noise : Check if there is any equipment causing harmonic wave near electric line. (Neon bulb or electric equipment that may cause harmonic wave) Check the complete insulation of grounding.



Check Point 2 : Check connection of Connector
<ul style="list-style-type: none"> • Check if connector is removed. • Check erroneous connection. • Check if cable is open. <p>>><u>Upon correcting the removed connector or mis-wiring, reset the power.</u></p>



Check Point 3 : Replace Main PCB
<p>▶ <u>If Check Point 1, 2 do not improve the symptom, change Main PCB.</u></p>

Trouble shooting 10 OUTDOOR UNIT Error Method: IPM error	Indicate or Display: Refer to error code table.
---	--

Detective Actuators: Outdoor unit Main PCB Compressor	Detective details: ① When more than normal operating current to IPM in Main PCB flows, the compressor stops. ② After the compressor restarts, if the same operation is repeated within 40sec, the compressor stops again. ③ If ① and ② repeats 5 times, the compressor stops permanently.
--	---

Forecast of Cause :		
1. Defective connection of electric components	2. Outdoor Fan Operation failure	5. Main PCB failure
3. Outdoor Heat Exchanger clogged	4. Compressor failure	

Check Point 1 : Check connections of Outdoor Unit Electrical Components
<ul style="list-style-type: none"> • Check if the terminal connection is loose. • Check if connector is removed. • Check erroneous connection. • Check if cable is open. <p>>> Upon correcting the removed connector or mis-wiring, reset the power.</p>



Check Point 2 : Check Outdoor Fan, Heat Exchanger
<ul style="list-style-type: none"> • Is there anything obstructing the air distribution circuit? • Is there any clogging of Outdoor Heat Exchanger? • Is the Fan rotating by hand when operation is off ? <p>>> If the Fan Motor is locked, replace it.</p>



Check Point 3 : Check Outdoor Fan
<ul style="list-style-type: none"> • Check Outdoor Fan Motor. (Refer to Trouble shooting 17) <p>>> If the Fan Motor is failure, replace it.</p>



Check Point 4 : Check Compressor
<ul style="list-style-type: none"> • Check Compressor. (PARTS INFORMATION 2)



Check Point 5 : Replace Main PCB
► If Check Point 1~ 4 do not improve the symptom, change Main PCB.

Trouble shooting 11 OUTDOOR UNIT Error Method: Discharge thermistor error	Indicate or Display: Refer to error code table.
--	--

Detective Actuators: Outdoor unit Main PCB Discharge pipe temperature thermistor	Detective details: When Discharge pipe temperature thermistor open or short-circuit is detected at power ON or while running the compressor.
---	--

Forecast of Cause :
1. Connector connection failure 2. Thermistor failure 3. Main PCB failure

Check Point 1 : Check connection of Connector

- Check if connector is removed.
- Check erroneous connection.
- Check if thermistor cable is open.

>>Upon correcting the removed connector or mis-wiring, reset the power.



Check Point 2 : Remove connector and check Thermistor resistance value

Thermistor Characteristics (Approx. value)

Temperature	-10°C	-5°C	0°C	5°C	10°C	20°C	30°C
Resistance Value (kΩ)	286.3	218.6	168.6	130.9	102.5	64.22	41.33

Temperature	40°C	50°C	60°C	70°C	80°C	90°C	100°C	110°C	120°C
Resistance Value (kΩ)	27.26	18.40	12.68	8.909	6.375	4.639	3.430	2.573	1.956

► If Thermistor is either open or shorted, replace it and reset the power.



Check Point 3 : Check voltage of Main PCB (DC5.0V)

Make sure circuit diagram of outdoor unit and check terminal voltage at Thermistor (DC5.0V)

THERMISTOR (PIPE) BLACK 1 1
BLACK 2 2
THERMISTOR (DISCHARGE) BLACK 3 3
BLACK 4 4 CN71
THERMISTOR (OUTDOOR) BLACK 1 1
BLACK 2 2
BLACK 3 3 CN70

► If the voltage does not appear, replace Main PCB.

Trouble shooting 12 OUTDOOR UNIT Error Method: Outdoor unit Heat Ex. sensor error	Indicate or Display: Refer to error code table.
--	--

Detective Actuators: Outdoor unit Main PCB Heat exchanger temperature thermistor	Detective details: When Heat exchanger temperature thermistor open or short-circuit is detected at power ON or while running the compressor.
---	--

Forecast of Cause :
1. Connector connection failure 2. Thermistor failure 3. Main PCB failure

Check Point 1 : Check connection of Connector

- Check if connector is removed.
- Check erroneous connection.
- Check if thermistor cable is open.

>>Upon correcting the removed connector or mis-wiring, reset the power.



Check Point 2 : Remove connector and check Thermistor resistance value Ω

Thermistor Characteristics (Approx. value)

Temperature	-10°C	-5°C	0°C	5°C	10°C	20°C	30°C	40°C	50°C
Resistance Value (k Ω)	27.21	20.80	16.05	12.47	9.775	6.129	3.947	2.606	1.759

Temperature	60°C	70°C	80°C
Resistance Value (k Ω)	1.213	0.8531	0.6115

► If Thermistor is either open or shorted, replace it and reset the power.



Check Point 3 : Check voltage of Main PCB (DC5.0V) DC

Make sure circuit diagram of outdoor unit and check terminal voltage at Thermistor (DC5.0V)

The diagram shows two thermistor components. The first is labeled 'THERMISTOR (PIPE)' and is connected to a 4-pin connector labeled 'CN71'. All four wires are labeled 'BLACK' and are connected to pins 1, 2, 3, and 4. The second is labeled 'THERMISTOR (OUTDOOR)' and is connected to a 3-pin connector labeled 'CN70'. All three wires are labeled 'BLACK' and are connected to pins 1, 2, and 3.

► If the voltage does not appear, replace Main PCB.

Trouble shooting 13 OUTDOOR UNIT Error Method: Outdoor thermistor error	Indicate or Display: Refer to error code table.
--	--

Detective Actuators: Outdoor unit Main PCB Outdoor temperature thermistor	Detective details: When Outdoor temperature thermistor open or short-circuit is detected at power ON or while running the compressor.
--	---

Forecast of Cause :
1. Connector connection failure 2. Thermistor failure 3. Main PCB failure

Check Point 1 : Check connection of Connector

- Check if connector is removed.
- Check erroneous connection.
- Check if thermistor cable is open.

>>Upon correcting the removed connector or mis-wiring, reset the power.



Ω

Check Point 2 : Remove connector and check Thermistor resistance value

Thermistor Characteristics (Approx. value)

Temperature	-20°C	-15°C	-10°C	-5°C	0°C	5°C	10°C
Resistance Value (kΩ)	109.0	80.56	60.23	45.40	34.57	26.53	20.56

Temperature	15°C	20°C	25°C	30°C	35°C	40°C	45°C	50°C	55°C
Resistance Value (kΩ)	16.04	12.26	10.00	7.978	6.408	5.184	4.216	3.451	2.841

► If Thermistor is either open or shorted, replace it and reset the power.



DC

Check Point 3 : Check voltage of Main PCB (DC5.0V)

Make sure circuit diagram of outdoor unit and check terminal voltage at Thermistor (DC5.0V)

THERMISTOR (PIPE) BLACK 1 1
BLACK 2 2
BLACK 3 3
BLACK 4 4 CN71

THERMISTOR (DISCHARGE)

THERMISTOR (OUTDOOR) BLACK 1 1
BLACK 2 2
BLACK 3 3 CN70

► If the voltage does not appear, replace Main PCB.

Trouble shooting 14 OUTDOOR UNIT Error Method: Current sensor error	<u>Indicate or Display:</u> Refer to error code table.
--	--

<u>Detective Actuators:</u> Outdoor unit Main PCB	<u>Detective details:</u> When Input Current Sensor has detected 0A, while Inverter Compressor is operating at higher than 56rps, after 1minute upon starting the Compressor. (Except during the defrost operation)
--	--

<u>Forecast of Cause :</u> 1. Defective connection of electric components 2. External cause 3. Main PCB failure
--

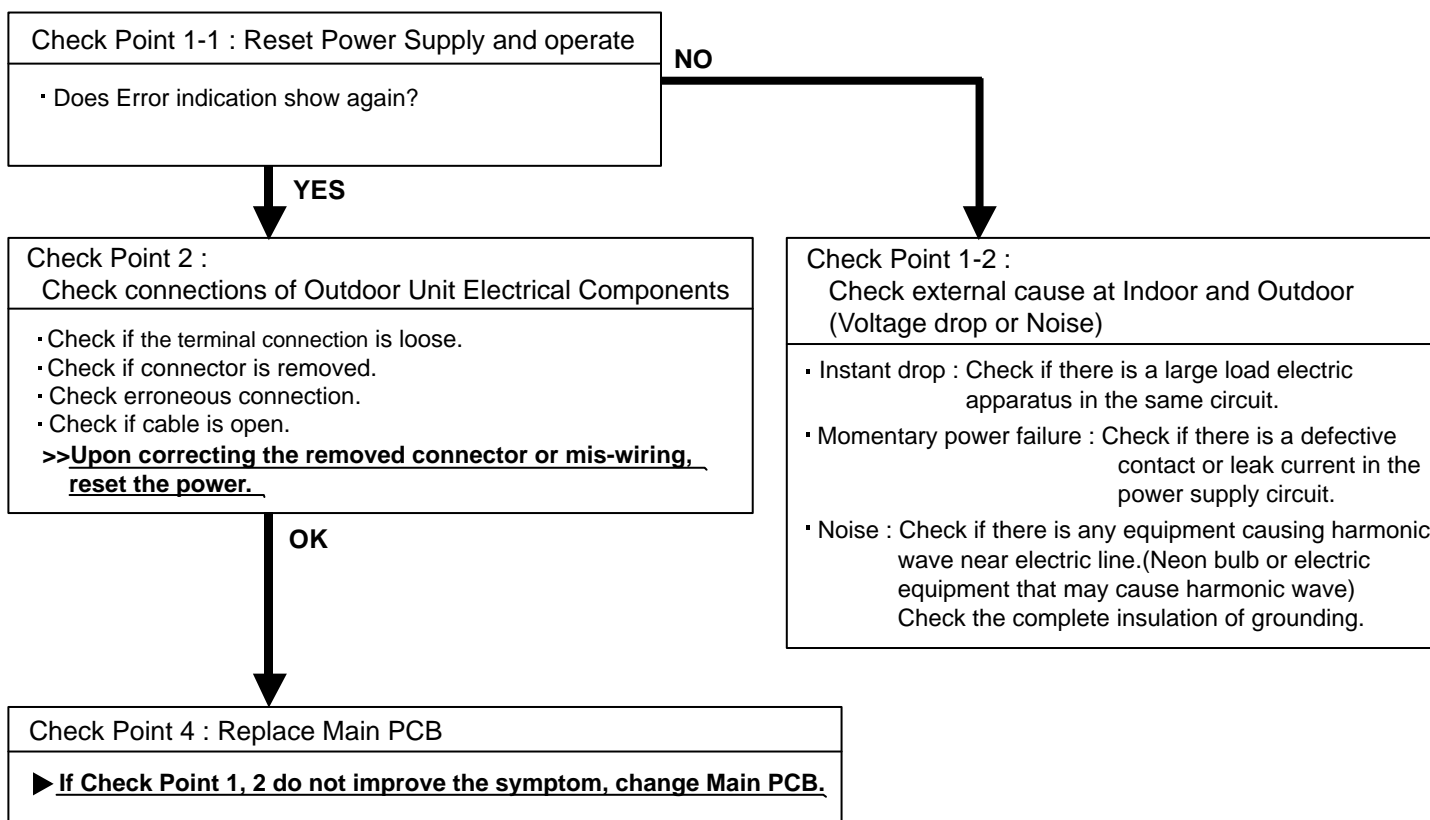

Trouble shooting 15 <u>OUTDOOR UNIT Error Method:</u> Trip detection	<u>Indicate or Display:</u> Refer to error code table.
---	---

<u>Detective Actuators:</u> Outdoor unit Main PCB Compressor	<u>Detective details:</u> ▪ "Protection stop by overcurrent generation after inverter compressor start processing completed" generated consecutively 10 times. * The number of generations is reset if the start-up of the compressor succeeds.
---	---

<u>Forecast of Cause :</u> <ol style="list-style-type: none"> 1. Outdoor unit fan operation defective, foreign matter on hear exchanger, excessive rise of ambient temperature 2. Inverter PCB failure 3. Inverter compressor failure (lock, winding short)

Check Point 1 : Check the outdoor unit fan operation, heat exchanger, ambient temperature <ul style="list-style-type: none"> • No obstructions in air passages? • Heat exchange fins clogged • Outdoor unit fan motor check • Ambient temperature not raised by the effect of other heat sources? • Discharged air not sucked in?
--

↓ **OK**

Check Point 2: Replace Main PCB ▶ <u>If Check Point 1 do not improve the symptom, change Main PCB.</u>

↓ **OK**

Check Point 3: Replace Compressor ▶ <u>If Check Point 2 do not improve the symptom, change Compressor.</u>

Trouble shooting 16 OUTDOOR UNIT Error Method: Compressor motor control error	Indicate or Display: Refer to error code table.
--	--

Detective Actuators: Outdoor unit Main PCB Compressor	Detective details: ① If the detected rotor location is out of phase with actual rotor location more than 90°, the compressor stops. After the compressor restarts, if the same operation is repeated ② within 40sec, the compressor stops again. ③ If ① and ② repeats 5 times, the compressor stops permanently.
--	---

Forecast of Cause : 1. Defective connection of electric components 2. Main PCB failure 3. Compressor failure
--

Check Point 1 : Check Noise from Compressor • Turn on Power and check operation noise. ▶ <u>If an abnormal noise show, replace Compressor.</u>
--



Check Point 2 : Check connection of around the Compressor components For Compressor Terminal, Main PCB • Check if connector is removed. • Check erroneous connection. • Check if cable is open. (Refer to PARTS INFORMATION 2) >><u>Upon correcting the removed connector or mis-wiring, reset the power.</u>



Check Point 3: Replace Main PCB ▶ <u>If Check Point 1,2 do not improve the symptom, change Main PCB.</u>



Check Point 4: Replace Compressor ▶ <u>If Check Point 3 do not improve the symptom, change Compressor.</u>

Trouble shooting 17 OUTDOOR UNIT Error Method: Outdoor unit fan motor error	Indicate or Display: Refer to error code table.
--	--

Detective Actuators: Outdoor unit Main PCB Outdoor unit Fan motor	Detective details: ① When outdoor fan rotation speed is less than 100rpm in 20 seconds after fan motor starts, fan motor stops. ② After fan motor restarts, if the same operation within 60sec is repeated 3 times in a row, compressor and fan motor stops. ③ If ① and ② repeats 5 times in a row, compressor and fan motor stops permanently.
--	---

Forecast of Cause: 1. Fan rotation failure 2. Motor protection by surrounding temperature rise 3. Main PCB failure 4. Outdoor unit fan motor

Check Point 1 : Check rotation of Fan
<ul style="list-style-type: none"> Rotate the fan by hand when operation is off. (Check if fan is caught, dropped off or locked motor) <p>>>If Fan or Bearing is abnormal, replace it.</p>



Check Point 2 : Check ambient temp. around motor
<ul style="list-style-type: none"> Check excessively high temperature around the motor. (If there is any surrounding equipment that causes heat) <p>>>Upon the temperature coming down, restart operation.</p>



Check Point 3 : Check Outdoor unit fan motor
<ul style="list-style-type: none"> Check Outdoor unit fan motor. (PARTS INFORMATION 5) <p>>>If Outdoor unit fan motor is abnormal, replace Outdoor unit fan motor.</p>



Check Point 4 : Check Output Voltage of Main PCB							
<ul style="list-style-type: none"> Check outdoor unit circuit diagram and the voltage. (Measure at Main PCB side connector) 							
<table border="1"> <thead> <tr> <th>Read wire</th> <th>DC voltage</th> </tr> </thead> <tbody> <tr> <td>Red - Black</td> <td>207V (AC230V-10%)~ 253V (AC230+10%)</td> </tr> <tr> <td>White - Black</td> <td>15 ± 1.5V</td> </tr> </tbody> </table>	Read wire	DC voltage	Red - Black	207V (AC230V-10%)~ 253V (AC230+10%)	White - Black	15 ± 1.5V	
Read wire	DC voltage						
Red - Black	207V (AC230V-10%)~ 253V (AC230+10%)						
White - Black	15 ± 1.5V						
▶ If the voltage is not correct, replace Main PCB.							

Trouble shooting 18 <u>INDOOR UNIT Error Method:</u> 4-way valve error	<u>Indicate or Display:</u> Refer to error code table.
--	--

<u>Detective Actuators:</u> Indoor unit Controller PCB Heat Ex. temperature thermistor Room temperature thermistor 4-way valve	<u>Detective details:</u> When the indoor heat exchanger temperature is compared with the room temperature, and either following condition is detected continuously two times, the compressor stops. <ul style="list-style-type: none"> ▪ Cooling or Dry operation [Indoor heat exchanger temp.] - [Room temp.] > 10degC ▪ Heating operation [Indoor heat exchanger temp.] - [Room temp.] < - 10degC If the same operation is repeated 5 times, the compressor stops permanently.
---	---

<u>Forecast of Cause :</u> 1. Connector connection failure 2. Thermistor failure 3. Coil failure 4. 4-way valve failure 5. Controller PCB failure
--

Check Point 1 : Check connection of Connector
<ul style="list-style-type: none"> ▪ Check if connector is removed. ▪ Check erroneous connection. ▪ Check if thermistor cable is open. >> <u>Upon correcting the removed connector or mis-wiring, reset the power.</u>



Check Point 2 : Check each thermistor
<ul style="list-style-type: none"> ▪ Isn't it fallen off the holder? ▪ Is there a cable pinched? >> <u>Check characteristics of thermistor (Refer to Trouble shooting 5, 6), If defective, replace the thermistor</u>



Check Point 3 : Check the solenoid coil and 4-way valve
<p>[Solenoid coil]</p> <ul style="list-style-type: none"> ▪ Remove CN30 from PCB and check the resistance value of coil. Resistance value is 1.88kΩ ~ 2.29kΩ (at 20°C). >> <u>If it is Open or abnormal resistance value, replace Solenoid Coil.</u> <p>[4-way valve]</p> <ul style="list-style-type: none"> ▪ Check each piping temperature, and the location of the valve by the temperature difference. >> <u>If the value location is not proper, replace 4-way valve.</u>



Check Point 4 : Replace Controller PCB
▶ <u>If Check Point 1- 3 do not improve the symptom, replace Controller PCB.</u>

Trouble shooting 19 OUTDOOR UNIT Error Method: Discharge temperature error	Indicate or Display: Refer to error code table.
---	--

Detective Actuators: Outdoor unit Main PCB Discharge temperature thermistor	Detective details: <ul style="list-style-type: none"> ▪ "Protection stop by "discharge temperature $\geq 110\text{degC}$ during compressor operation"" generated 2 times within 24 hours.
--	---

Forecast of Cause :	1. 2,3-way valve not opened 2. EEV defective, strainer clogged 3. Outdoor unit operation failure, foreign matter on heat exchanger 4. Discharge temperature thermistor failure 5. Insufficient refrigerant 6. Main PCB failure
----------------------------	---

<Cooling operation>

Check Point 1 : Check if 3-way valve is open.
▪ If the 3-way valve was closed, open the 3-way valve and check operation.

↓
OK

Check Point 2 : Check the EEV, strainer
▪ EEV open? ▪ Strainer clogging check (before and after EEV) Refer to "Service Parts Information 3".

↓
OK

Check Point 3 : Check the outdoor unit fan, heat exchanger
▪ Check for foreign object at heat exchanger ▪ Check if fan can be rotated by hand. ▪ Motor check (PARTS INFORMATION 5)

↓
OK

Check Point 4 : Check the discharge thermistor
▪ Discharge thermistor characteristics check. (Check by disconnecting thermistor from PCB.) * For the characteristics of the thermistor, refer to the "Trouble shooting 11".

↓
OK

Check Point 5 : Check the refrigerant amount
▪ Leak check

<Heating operation>

Check Point 1 : Check if 2-way valve is open.
▪ If the 2-way valve was closed, open the 2-way valve and check operation.

↓
OK

Check Point 2 : Check the EEV, strainer
▪ EEV open? ▪ Strainer clogging check (before and after EEV) Refer to "Service Parts Information 3".

↙
OK

2-3 TROUBLE SHOOTING WITH NO ERROR CODE

Trouble shooting 20

Indoor Unit - No Power

Forecast of Cause:

1. Power supply failure
2. External cause
3. Electrical components defective

Check Point 1 : Check Installation Condition

- Isn't the breaker down?
- Check loose or removed connection cable.
- >> **If abnormal condition is found, correct it by referring to Installation Manual or Data & Technical Manual.**

↓ OK

Check Point 2 : Check external cause at Indoor and Outdoor (Voltage drop or Noise)

- Instant drop ----- Check if there is a large load electric apparatus in the same circuit.
- Momentary power failure ----- Check if there is a defective contact or leak current in the power supply circuit.
- Noise ----- Check if there is any equipment causing harmonic wave near electric line.
(Neon bulb or electric equipment that may cause harmonic wave)
Check the complete insulation of grounding.

↓ OK

Check Point 3 : Check Electrical Components



- Check the voltage of power supply.
- >> **Check if AC207 - 253V appears at Outdoor Unit Terminal L - N.**

↓ YES

- Check Fuse in Main PCB.
>> **If Fuse is open, check if the wiring between Terminal and Main PCB is loose, and replace Fuse.**
- Check Varistor in Main PCB.
>> **If Varistor is defective, there is a possibility of an abnormal power supply. Check the correct power supply and replace Varistor. Upon checking the normal power supply, replace Varistor.**

NO

Trouble shooting 21

Outdoor Unit - No Power

Forecast of Cause:

1. Power supply failure
2. External cause
3. Electrical Components defective

Check Point 1 : Check Installation Condition

- Isn't the breaker down?
- Check loose or removed connection cable.
- >>If abnormal condition is found, correct it by referring to Installation Manual or Data & Technical Manual.**

OK

Check Point 2 : Check external cause at Indoor and Outdoor (Voltage drop or Noise)

- Instant drop ----- Check if there is a large load electric apparatus in the same circuit.
- Momentary power failure ----- Check if there is a defective contact or leak current in the power supply circuit.
- Noise ----- Check if there is any equipment causing harmonic wave near electric line.
(Neon bulb or electric equipment that may cause harmonic wave)
Check the complete insulation of grounding.

OK

Check Point 3 : Check Electrical Components

- Check the voltage of power supply.
- >> Check if AC207 - 253V appears at Outdoor Unit Terminal L - N.**

YES

- Check Fuse in Main PCB.
- >> If Fuse is open, check if the wiring between Terminal and Main PCB is loose, and replace Fuse.**
- Check Varistor in Main PCB.
- >> If Varistor is defective, there is a possibility of an abnormal power supply. Check the correct power supply and replace Varistor. Upon checking the normal power supply, replace Varistor.**

OK

► **If the symptom does not change by above Check 3, replace Main PCB.**

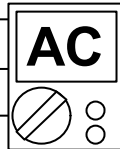

NO

Trouble shooting 22

No Operation (Power is ON)

Forecast of Cause:

1. Setting/ Connection failure
2. External cause
3. Electrical component defective

Check Point 1 : Check indoor and outdoor installation condition

- Indoor Unit - Check incorrect wiring between Indoor Unit - Remote Control.
Or, check if there is an open cable connection.
- Are these Indoor Unit, Outdoor Unit, and Remote Control suitable model numbers to connect?
>> If there is some abnormal condition, correct it by referring to Installation manual and Data & Technical Manual.

OK

Turn off Power and check/ correct followings.

- Is there loose or removed communication line of Indoor Unit and Outdoor Unit?

OK

Check Point 2 : Check external cause at Indoor and Outdoor (Voltage drop or Noise)

- Instant drop ----- Check if there is a large load electric apparatus in the same circuit.
- Momentary power failure ----- Check if there is a defective contact or leak current in the power supply circuit.
- Noise ----- Check if there is any equipment causing harmonic wave near electric line.
(Neon bulb or electric equipment that may cause harmonic wave)
Check the complete insulation of grounding.

OK

Check Point 3 : Check Electrical Components at Indoor and Outdoor

- Check Voltage at CNC01 (terminal 1-3) of UTY-XCBXZ2 (Communication kit).
(Power supply to Remote Control)

- >> If it is DC13V, Remote Control is failure. (Controller PCB is normal) >> Replace Remote Control**
- >> If it is DC 0V, Controller PCB is failure. (Check Remote Control once again)**
 - >> Check Indoor unit fan motor. (PARTS INFORMATION 4)**
 - If it is normal, replace Controller PCB.
 - If it is abnormal, replace Indoor unit fan motor and Controller PCB.
- >> If the symptom does not change by above Check 1, 2, 3, replace Main PCB of Outdoor unit.**



Trouble shooting 23

No Cooling / No Heating

Forecast of Cause:

1. Indoor Unit error
2. Outdoor Unit error
3. Effect by surrounding environment
4. Connection pipe / Connection wire failure
5. Refrigeration cycle failure

Check Point 1 : Check Indoor unit

- Does Indoor unit Fan run on High fan?
- Is Air filter dirty?
- Is Heat exchanger clogged?
- Check if Energy save function is operated.



Check Point 2 : Check Outdoor unit operation

- Check if Outdoor unit is operating
- Check any objects that obstruct the air flow route.
- Check clogged Heat Exchanger.
- Is the Valve open?



Check Point 3 : Check Site condition

- Is capacity of Indoor unit fitted to room size?
- Any windows open? or direct sunlight ?



Check Point 4 : Check Indoor/ Outdoor installation condition

- Check connection pipe (specified pipe length & Pipe diameter?)
- Check any loose or removed communication line.
- >> **If there is an abnormal condition, correct it by referring to Installation Manual or Data & Technical Manual.**



Check Point 5 : Check Refrigeration cycle

- Check if Strainer is clogged (Refer to the figure at right).
- Measure Gas Pressure and if there is a leakage, correct it.
- >> **When recharging the refrigerant, make sure to perform vacuuming, and recharge the specified amount.**
- Check EEV (PARTS INFORMATION 3)
- Check Compressor (PARTS INFORMATION 1,2)

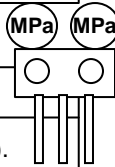

Attention

Strainer normally does not have temperature difference between inlet and outlet as shown in ①, but if there is a difference like shown in ②, there is a possibility of inside clogged. In this case, replace Strainer.

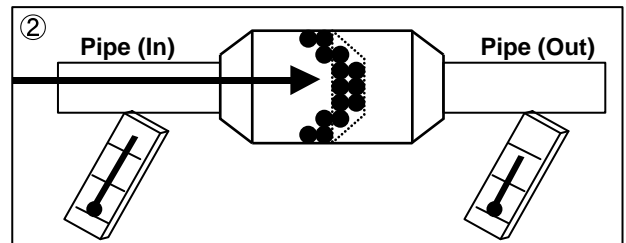
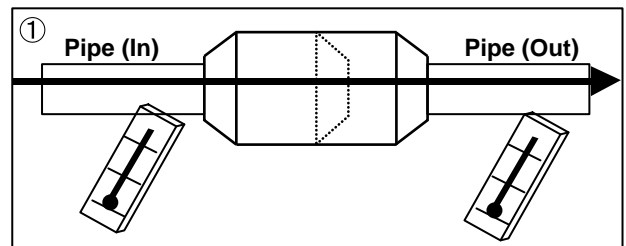

Trouble shooting 24

Abnormal Noise

Forecast of Cause :

1. Abnormal installation (Indoor/ Outdoor)
2. Fan failure (Indoor/ Outdoor)
3. Compressor failure (Outdoor)

Diagnosis method when abnormal noise is occurred

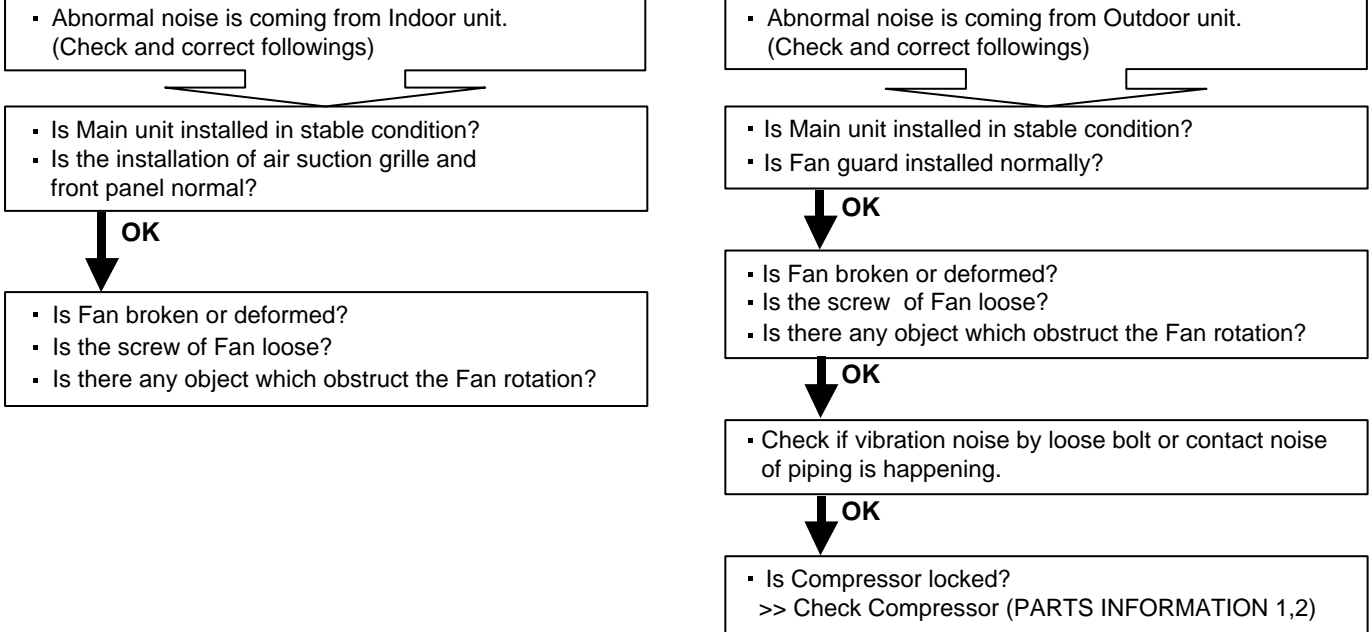

Trouble shooting 25

Water Leaking

Forecast of Cause:

1. Erroneous installation
2. Drain hose failure

Diagnosis method when water leak occurs

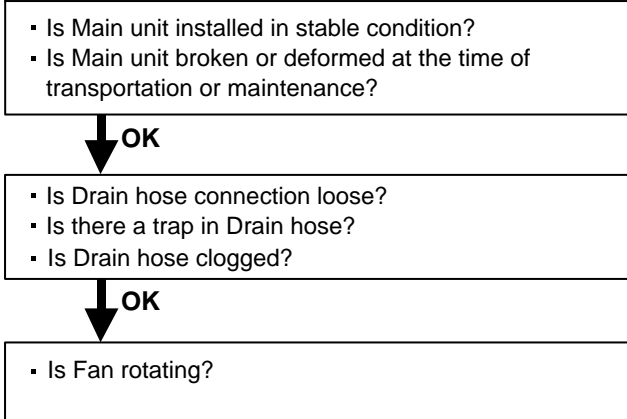

Diagnosis method when water is spitting out.

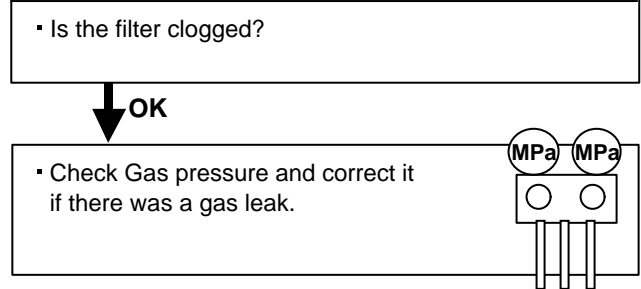

2-4 SERVICE PARTS INFORMATION

SERVICE PARTS INFORMATION 1

Compressor

Diagnosis method of Compressor (If Outdoor Unit LED displays Error, refer to Trouble shooting)

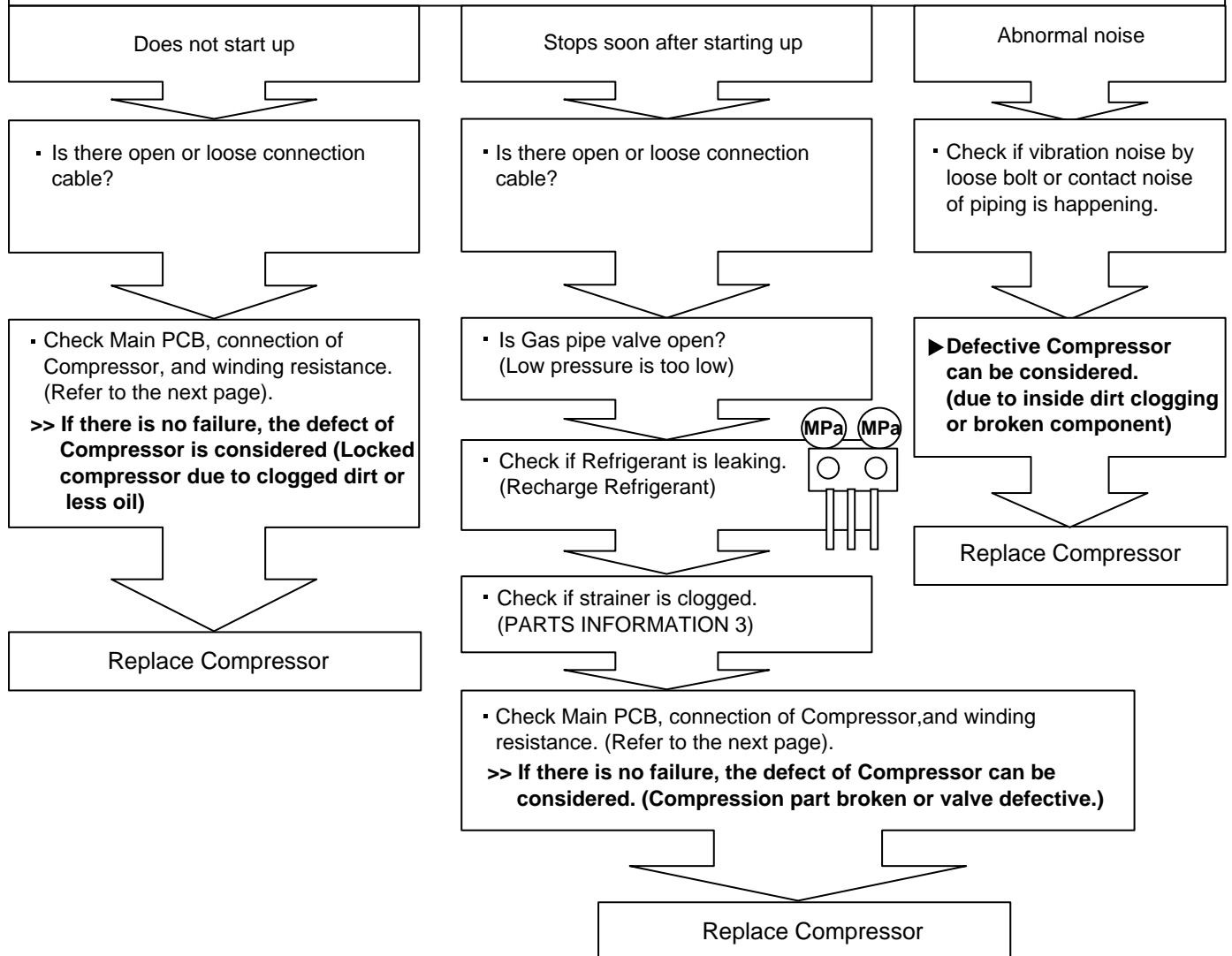

SERVICE PARTS INFORMATION 2

Inverter Compressor

Check Point 1 : Check Connection

- Check terminal connection of Compressor (loose or incorrect wiring)

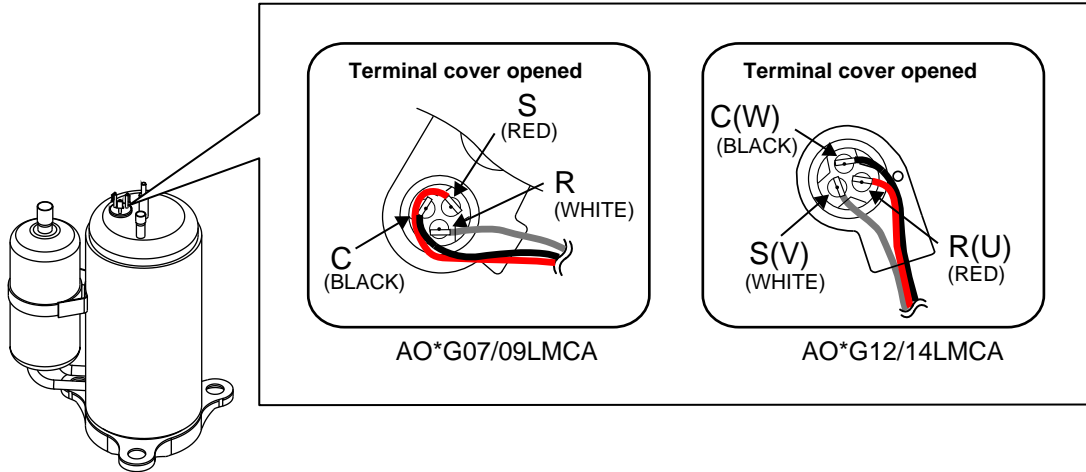

Check Point 2 : Check Winding Resistance

- Check winding resistance of each terminal

► **If the resistance value is 0Ω or infinite, replace Compressor.**

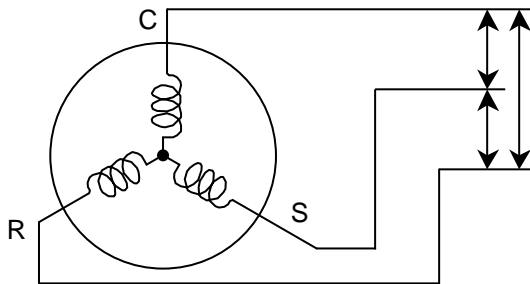

- **AO*G07/09LMCA**
Resistance Value :
3.3Ω at 20°C
- **AO*G12LMCA**
Resistance Value :
1.3Ω at 20°C
- **AO*G14LMCA**
Resistance Value :
0.7Ω at 20°C

Check Point 3 : Replace Main PCB

► **If the symptom does not change with above Check 1, 2, replace Main PCB.**

SERVICE PARTS INFORMATION 3

Outdoor unit Electronic Expansion Valve (EEV)

Check Point 1 : Check Connections

- Check connection of connector (CN40) (Loose connector or open cable)

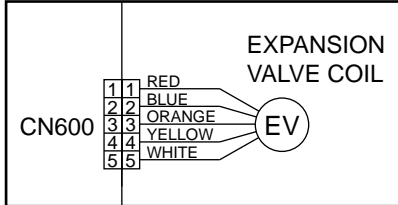

Check Point 2 : Check Coil of EEV

- Remove connector, check each winding resistance of Coil.

Read wire	Resistance value
White - Red	$46 \Omega \pm 4 \Omega$ at 20°C
Yellow - Red	
Orange - Red	
Blue - Red	

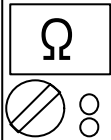

► **If Resistance value is abnormal, replace EEV.**

Check Point 3 : Check Noise at start up

- Turn on Power and check operation noise.
- **If an abnormal noise does not show, replace Main PCB.**

Check Point 4 : Check Voltage from Main PCB.

- Remove Connector and check Voltage (DC12V)
- **If it does not appear, replace Main PCB.**



Check Point 5 : Check Opening and Closing Operation of Valve

When Valve is closed, it has a temp. difference between Inlet and Outlet.

CLOSE
Example : Hot Gas

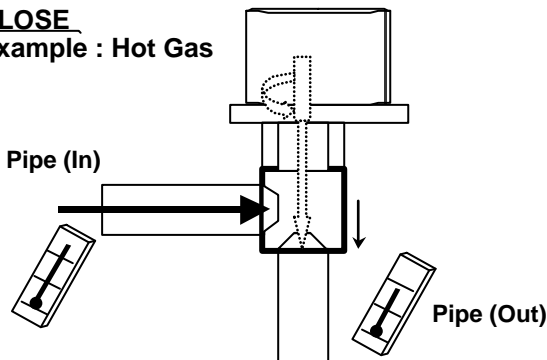

If it is open, it has no temp. difference between Inlet and Outlet.

OPEN
Example : Hot Gas

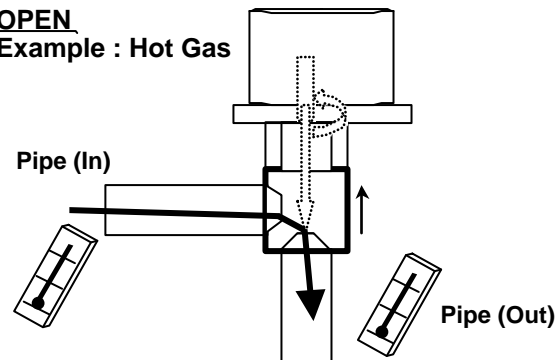

Check Point 6 : Check Strainer

Strainer normally does not have temperature difference between inlet and outlet as shown in ①, but if there is a difference as shown in ②, there is a possibility of inside clogged. In this case, replace Strainer.

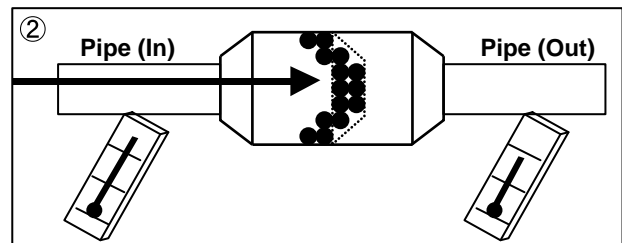
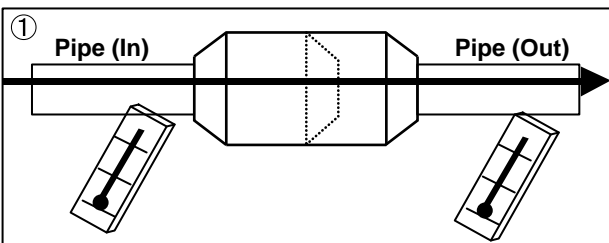

SERVICE PARTS INFORMATION 4

Indoor unit fan motor

Check Point 1 : Check rotation of Fan

- Rotate the fan by hand when operation is off.
(Check if fan is caught, dropped off or locked motor)
- >>If Fan or Bearing is abnormal, replace it.**

Check Point 2 : Check resistance of Indoor Fan Motor

- Refer to below. Circuit-test "Vm" and "GND" terminal.
(Vm: DC voltage, GND: Earth terminal)
- >>If they are short-circuited (below 300 k Ω), replace Indoor fan motor and Controller PCB.**

Pin number (wire color)	Terminal function (symbol)
1 (Blue)	Feed back (FG)
2 (Yellow)	Speed command (Vsp)
3 (White)	Control voltage (Vcc)
4 (Black)	Earth terminal (GND)
5	No function
6 (Red)	DC voltage (Vm)

SERVICE PARTS INFORMATION 5

Outdoor unit fan motor

Check Point 1 : Check rotation of Fan

- Rotate the fan by hand when operation is off.
(Check if fan is caught, dropped off or locked motor)
- >>If Fan or Bearing is abnormal, replace it.**

Check Point 2 : Check resistance of Outdoor Fan Motor

- Refer to below. Circuit-test "Vm" and "GND" terminal.
(Vm: DC voltage, GND: Earth terminal)
- >>If they are short-circuited (below 300 k Ω), replace Outdoor fan motor and Main PCB.**

Pin number (wire color)	Terminal function (symbol)
1 (Red)	DC voltage (Vm)
2	No function
3	No function
4 (Black)	Earth terminal (GND)
5 (White)	Control voltage (Vcc)
6 (Yellow)	Speed command (Vsp)
7 (Brown)	Feed back (FG)

WALL MOUNTED type INVERTER

3 . APPENDING DATA

3-1. FUNCTION SETTING

3-1-1 INDOOR UNIT

- Follow the instructions in the Local Setup Procedure, which is supplied with the remote control, in accordance with the installed condition.
After the power is turned on, perform the Function Setting on the remote control.
- The settings may be selected between the following two: Function Number or Setting Value.
- Settings will not be changed if invalid numbers or setting values are selected.

1-1. Setting the Filter Sign

The indoor unit has a sign to inform the user that it is time to clean the filter.

Select the time setting for the filter sign display interval in the table below according to the amount of dust or debris in the room.

If you do not wish the filter sign to be displayed, select the setting value for "No indication".

(◆ . . . Factory setting)

Setting Description	Function Number	Setting Value
Standard (400 hours)	11	00
Long interval (1000 hours)		01
Short interval (200 hours)		02
◆ No indication		03

1-2. Cooling Room Temperature Correction

Depending on the installed environment, the room temperature sensor may require a correction. The settings may be selected as shown in the table below.

(◆ . . . Factory setting)

Setting Description	Function Number	Setting Value
◆ Standard	30	00
Slightly lower control		01
Lower control		02
Warmer control		03

1-3. Heating Room Temperature Correction

Depending on the installed environment, the room temperature sensor may require a correction. The settings may be selected as shown in the table below.

(◆ . . . Factory setting)

Setting Description	Function Number	Setting Value
◆ Standard	31	00
Lower control		01
Slightly warmer control		02
Warmer control		03

1-4. Setting the Auto Restart

Enable or disable automatic system restart after a power outage.

(◆ . . . Factory setting)

Setting Description	Function Number	Setting Value
◆ Yes	40	00
No		01

**1-5. Indoor room temperature sensor switching function
(Only for Wired remote controller)**

The following settings are needed when use the control by Wired remote controller temperature sensor.

(◆ . . . Factory setting)

Setting Description	Function Number	Setting Value
◆ No	42	00
Yes		01

* If setting value is "00" : Room temperature is controlled by the indoor unit temperature sensor.

* If setting value is "01" : Room temperature is controlled by either indoor unit temperature sensor or remote controller unit sensor.

1-6. Remote controller signal code

Change the indoor unit Signal Code, depending on the remote controllers.

(◆ . . . Factory setting)

Setting Description	Function Number	Setting Value
◆ A	44	00
B		01
C		02
D		03

1-7. External input control

"Operation/Stop" mode or "Forced stop" mode can be elected.

(◆ . . . Factory setting)

Setting Description	Function Number	Setting Value
◆ Operation/Stop mode	46	00
(Setting forbidden)		01
Forced stop mode		02

1-8. Indoor unit fan control for energy saving

Enable or disable indoor unit fan control when the outdoor unit is stopped.

(◆ . . . Factory setting)

Setting Description	Function Number	Setting Value
◆ No	49	00
Yes		01

* If setting value is "00" : When the outdoor unit is stopped, the indoor unit fan operates following the setting on the remote controller continuously.

* If setting value is "01" : When the outdoor unit is stopped, the indoor unit fan operates at very low speed intermittently.

3-1-2 Procedures to change the Function Setting for wireless RC

- This procedure changes to the function settings used to control the indoor unit according to the installation conditions. Incorrect settings can cause the indoor unit malfunction.
- After the power is turned on, perform the "FUNCTION SETTING" according to the installation conditions using the remote controller.
- Settings will not be changed if invalid numbers or setting values are selected.

Entering the Function Setting Mode

- While pressing the POWERFUL button and SET TEMP.(^) button simultaneously, press the RESET button to enter the function setting mode.

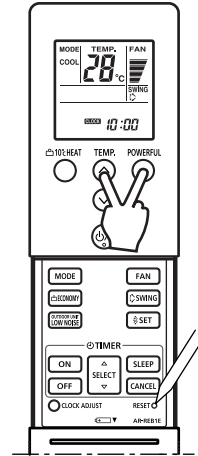

Selecting the Function Number and Setting Value

- (1) Press the SET TEMP.(^) (^) buttons to select the function number.
(Press the 10°C HEAT button to switch between the left and right digits.)

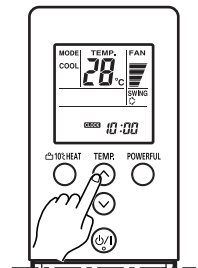

- (2) Press the POWERFUL button to proceed to setting the value.
(Press the POWERFUL button again to return to the function number selection.)

- (3) Press the SET TEMP.(^) (^) buttons to select the setting value.
(Press the 10°C HEAT button to switch between the left and right digits.)

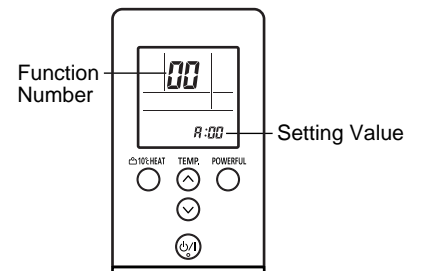

- (4) Press the MODE button, in the order listed to confirm the setting.
Please confirm that the beep sounds.

- (5) Next, please press the START/STOP(⏻/⏩) button.
Please confirm that the beep sounds.



- (6) Press the RESET button to cancel the function setting mode.
- (7) After completing the FUNCTION SETTING, be sure to turn off the power and turn it on again.

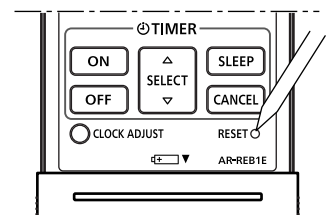
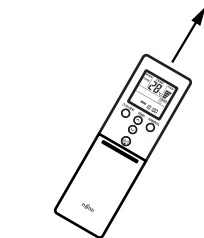

⚠ CAUTION

After turning off the power, wait 10 seconds or more before turning on it again.
The FUNCTION SETTING doesn't become active unless the power is turned off then on again.

Selecting the Remote Controller Signal Code

- (1) Press the START/STOP(⏻/⏪) button until only the clock is displayed on the remote controller display.
- (2) Press the MODE button for at least 5 seconds to display the current signal code. (initially set to A).
- (3) Press the SET TEMP.(^)(v) buttons to change the signal code between A→b→c→d.
Match the code on the display to the air conditioner signal code.
- (4) Press the MODE button again to return to the clock display.
The signal code will be changed.

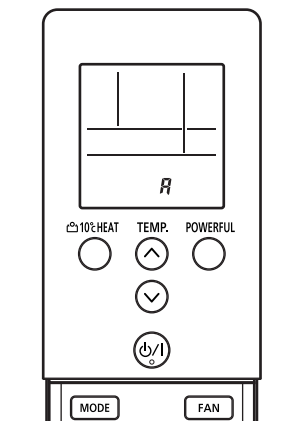

CAUTION

- If no buttons are pressed within 30 seconds after the signal code is displayed, the system returns to the original clock display.
- In this case, start again from step 1.
The air conditioner signal code is set to A prior to shipment.

3-2. Thermistor Resistance Values

3-2-1 INDOOR UNIT

Room temperature thermistor		
Temp (°C)	Resistance(k Ω)	Voltage(V)
-10.0	55.46	0.76
-5.0	42.36	0.95
0.0	32.67	1.17
5.0	25.39	1.41
10.0	19.91	1.67
15.0	15.71	1.94
20.0	12.5	2.22
25.0	10.0	2.50
30.0	8.051	2.77
35.0	6.52	3.03
40.0	5.316	3.26
45.0	4.354	3.48

Indoor heat exchanger thermistor		
Temp (°C)	Resistance(k Ω)	Voltage(V)
-30.0	977.6	0.24
-25.0	713.2	0.33
-20.0	526.8	0.43
-15.0	392.1	0.56
-10.0	295.1	0.72
-5.0	223.3	0.91
0.0	170.7	1.13
5.0	131.4	1.38
10.0	102.1	1.64
15.0	79.81	1.92
20.0	62.9	2.21
25.0	49.84	2.50
30.0	39.78	2.78
35.0	31.92	3.05
40.0	25.8	3.30
45.0	20.94	3.52
50.0	17.11	3.72
55.0	14.05	3.90
60.0	11.6	4.06
63.0	10.36	4.14

3-2-2 OUTDOOR UNIT

Discharge thermistor		
Temp (°C)	Resistance(k Ω)	Voltage(V)
-30.0	920.3	0.07
-25.0	676.6	0.09
-20.0	503.5	0.13
-15.0	377.6	0.17
-10.0	286.3	0.22
-5.0	218.6	0.28
0.0	168.6	0.36
5.0	130.9	0.45
10.0	102.5	0.56
15.0	80.82	0.69
20.0	64.22	0.84
25.0	51.36	1.01
30.0	41.33	1.20
35.0	33.64	1.39
40.0	27.26	1.61
45.0	22.33	1.84
50.0	18.40	2.07
55.0	15.23	2.30
60.0	12.68	2.53
65.0	10.60	2.75
70.0	8.909	2.97
75.0	7.518	3.17
80.0	6.375	3.35
85.0	5.427	3.53
90.0	4.639	3.69
95.0	3.981	3.83
100.0	3.430	3.96
105.0	2.965	4.07
110.0	2.573	4.17
115.0	2.239	4.27
120.0	1.956	4.35

Outdoor heat exchanger thermistor		
Temp (°C)	Resistance(k Ω)	Voltage(V)
-30.0	87.21	0.26
-25.0	64.16	0.34
-20.0	47.78	0.45
-15.0	35.86	0.58
-10.0	27.21	0.74
-5.0	20.80	0.93
0.0	16.05	1.14
5.0	12.47	1.38
10.0	9.775	1.64
15.0	7.709	1.91
20.0	6.129	2.18
25.0	4.903	2.46
30.0	3.947	2.73
35.0	3.196	2.99
40.0	2.606	3.23
45.0	2.135	3.45
50.0	1.759	3.65
55.0	1.457	3.83
60.0	1.213	3.98
65.0	1.015	4.12
70.0	0.8531	4.24
75.0	0.7206	4.34
80.0	0.6115	4.43

Outdoor temperature thermistor		
Temp (°C)	Resistance(k Ω)	Voltage(V)
-30.0	205.7	0.78
-25.0	148.8	1.02
-20.0	109.0	1.30
-15.0	80.56	1.61
-10.0	60.23	1.94
-5.0	45.40	2.29
0.0	34.57	2.63
5.0	26.53	2.95
10.0	20.56	3.25
15.0	16.04	3.52
20.0	12.26	3.79
25.0	10.00	3.96
30.0	7.978	4.14
35.0	6.408	4.28
40.0	5.184	4.40
45.0	4.216	4.50
50.0	3.451	4.59
55.0	2.841	4.65

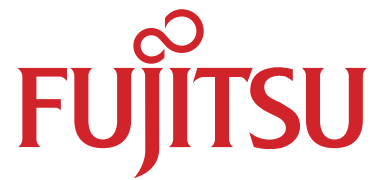

FUJITSU GENERAL LIMITED

1116, Suenaga, Takatsu-ku, Kawasaki 213-8502, Japan