

AIR CONDITIONER

Wall Mounted Type

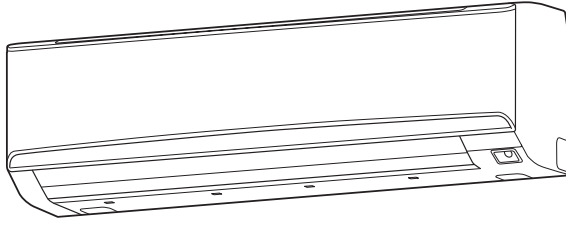

INSTALLATION MANUAL



PART No. 9387082050

[Original instructions]

For authorized service personnel only.

1. SAFETY PRECAUTIONS

- Be sure to read this manual thoroughly before installation.
- The warnings and precautions indicated in this manual contain important information pertaining to your safety. Be sure to observe them.
- Hand this manual, together with the operating manual, to the customer. Request the customer to keep them on hand for future use, such as for relocating or repairing the unit.

WARNING

Indicates a potentially or imminently hazardous situation which, if not avoided, could result in death or serious injury.

CAUTION

Indicates a potentially hazardous situation that may result in minor or moderate injury or damage to property.

WARNING

- Installation of this product must be done by experienced service technicians or professional installers only in accordance with this manual. Installation by non-professional or improper installation of the product might cause serious accidents such as injury, water leakage, electric shock, or fire. If the product is installed in disregard of the instructions in this manual, it will void the manufacturer's warranty.
- Do not turn on the power until all work has been completed. Turning on the power before the work is completed can cause serious accidents such as electric shock or fire.
- If refrigerant leaks when you are working, ventilate the area. If the leaking refrigerant is exposed to a direct flame, it may produce a toxic gas.
- Installation must be performed in accordance with regulations, codes, or standards for electrical wiring and equipment in each country, region, or the installation place.
- Do not use means to accelerate the defrosting process or to clean, other than those recommended by the manufacturer.
- This appliance is not intended for use by persons (including children) with reduced physical, sensory or mental capabilities, or lack of experience and knowledge, unless they have been given supervision or instruction concerning use of the appliance by a person responsible for their safety. Children should be supervised to ensure that they do not play with the appliance.

CAUTION

- Read carefully all safety information written in this manual before you install or use the air conditioner.
- Install the product by following local codes and regulations in force at the place of installation, and the instructions provided by the manufacturer.
- This product is part of a set constituting an air conditioner. The product must not be installed alone or be installed with non-authorized device by the manufacturer.
- Always use a separate power supply line protected by a circuit breaker operating on all wires with a distance between contact of 3 mm for this product.
- To protect the persons, earth (ground) the product correctly, and use the power cable combined with an Earth Leakage Circuit Breaker (ELCB).

Contents

1. SAFETY PRECAUTIONS	1
2. ABOUT THIS PRODUCT.....	1
3. GENERAL SPECIFICATION	2
4. ELECTRICAL REQUIREMENT	2
5. SELECTING THE MOUNTING POSITION	3
6. INSTALLATION WORK	3
7. ELECTRICAL WIRING	5
8. FINISHING	6
9. FRONT PANEL REMOVAL AND INSTALLATION	7
10. TEST RUN.....	7
11. REMOTE CONTROLLER INSTALLATION.....	7
12. OPTIONAL KIT INSTALLATION	7
13. SELECTING THE REMOTE CONTROLLER CUSTOM CODE	8
14. FUNCTION SETTING.....	8
15. CUSTOMER GUIDANCE	10
16. ERROR CODES.....	10

CAUTION

- This product is not explosion proof, and therefore should not be installed in explosive atmosphere.
- To avoid getting an electric shock, never touch the electrical components soon after the power supply has been turned off. After turning off the power, always wait 5 minutes or more before you touch the electrical components.
- This product contains no user-serviceable parts. Always consult experienced service technicians for repairing.
- When moving or relocating the air conditioner, consult experienced service technicians for disconnection and reinstallation of the product.
- Do not place any other electrical products or household belongings under the product. Condensation dripping from the product might get them wet, and may cause damage or malfunction to the property.

- Be careful not to scratch the air conditioner when handling it.
- After installation, explain correct operation to the customer, using the operating manual.

2. ABOUT THIS PRODUCT

2.1. Precautions for using R410A refrigerant

The basic installation work procedures are the same as conventional refrigerant (R22) models.

However, pay careful attention to the following points:

Since the working pressure is 1.6 times higher than that of conventional refrigerant (R22) models, some of the piping and installation and service tools are special. (See the table below.)

Especially, when replacing a conventional refrigerant (R22) model with a new refrigerant R410A model, always replace the conventional piping and flare nuts with the R410A piping and flare nuts.

Models that use refrigerant R410A have a different charging port thread diameter to prevent erroneous charging with conventional refrigerant (R22) and for safety. Therefore, check beforehand. [The charging port thread diameter for R410A is 1/2-20 UNF]

Be more careful that foreign matter (oil, water, etc.) does not enter the piping than with refrigerant (R22) models. Also, when storing the piping, securely seal the opening by pinching, taping, etc.

When charging the refrigerant, take into account the slight change in the composition of the gas and liquid phases. And always charge from the liquid phase where refrigerant composition is stable.

English

Deutsch

Français

Español

Italiano

Ελληνικά

Portugués

Русский

Türkçe

2.2. Special tools for R410A

Tool name	Change from R22 to R410A
Gauge manifold	Pressure is high and cannot be measured with a R22 gauge. To prevent erroneous mixing of other refrigerants, the diameter of each port has been changed. It is recommended to use gauge with seals -0.1 to 5.3 MPa (-1 to 53 bar) for high pressure. -0.1 to 3.8 MPa (-1 to 38 bar) for low pressure.
Charge hose	To increase pressure resistance, the hose material and base size were changed. (R410A)
Vacuum pump	A conventional vacuum pump can be used by installing a vacuum pump adapter. (Use of a vacuum pump with a series motor is prohibited.)
Gas leakage detector	Special gas leakage detector for HFC refrigerant R410A.

Copper pipes

It is necessary to use seamless copper pipes and it is desirable that the amount of residual oil is less than 40 mg/10 m. Do not use copper pipes having a collapsed, deformed or discolored portion (especially on the interior surface). Otherwise, the expansion value or capillary tube may become blocked with contaminants.

As an air conditioner using R410A incurs pressure higher than when using R22, it is necessary to choose adequate materials.

⚠ WARNING

- Do not use the existing (for R22) piping and flare nuts. If the existing materials are used, the pressure inside the refrigerant cycle will rise and cause failure, injury, etc. (Use the special R410A materials.)
- Use (refill or replace with) specified refrigerant (R410A) only. Use of unspecified refrigerant can cause product malfunction, burst, or injury.
- Do not mix any gas or impurities except specified refrigerant (R410A). Inflow of air or application of unspecified material makes the internal pressure of the refrigerant cycle too high, and may cause product malfunction, burst of piping, or injury.

⚠ WARNING

- For appropriate working of the air conditioner, install it as written in this manual.
- To connect indoor unit and outdoor unit, use air conditioner piping and cables available through your local distributor. This manual describes proper connections using such installation set.
- Do not turn on the power until all work has been completed.











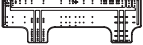

⚠ CAUTION

This manual describes how to install the indoor unit only. To install the outdoor unit, (if any), refer to the installation manual included in each product.

- Be careful not to scratch the air conditioner when handling it.
- After installation, explain correct operation to the customer, using the operating manual.

2.3. Accessories

The following installation accessories are supplied. Use them as required.

Name and Shape	Q'ty	Name and Shape	Q'ty
Operating Manual 	1	Cloth tape 	1
Installation Manual (This manual) 	1	Tapping screw (Large) 	8
Wall hook bracket 	1	Tapping screw (Small) 	2
Remote controller 	1	Air cleaning filter 	2
Battery 	2	Filter holders 	2
Remote controller holder 	1	Drain hose insulation 	1

The following items are necessary to install this air conditioner. (The items are not included with the air conditioner and must be purchased separately.)

Name	Q'ty	Name	Q'ty
Connection pipe assembly	1	Wall cap	1
Connection cable (4-conductor)	1	Saddle	1 set
Wall pipe	1	Drain hose	1
Decorative tape	1	Tapping screws	1 set
Vinyl tape	1	Sealant	1

2.4. Optional parts

Refer to each installation manual for the method of installing optional parts.

Parts name	Model name	Application
Wired Remote Controller *	UTY-RVN*M	For air conditioner operation
Wired Remote Controller **	UTY-RNR*Z1	For air conditioner operation
Wired Remote Controller **	UTY-RLR*	For air conditioner operation
Simple Remote Controller *	UTY-RSN*M	For air conditioner operation
Communication kit	UTY-XWNX	For the installation of optional parts
Communication kit	UTY-TWRX	For the installation of optional parts
External connect kit	UTY-XWZX	For control input/output port
External input and output PCB ***	UTY-GXXB	For connecting external devices
PCB kit	UTY-XCSXZ1	For the installation of optional parts

* Optional communication kit (UTY-XWNX) is necessary for the installation.

** Optional communication kit (UTY-TWRX) is necessary for the installation.

*** Optional PCB kit (UTY-XCSXZ1) is necessary for the installation.

3. GENERAL SPECIFICATION

This INSTALLATION MANUAL briefly outlines where and how to install the air conditioning system. Please read over the entire set of instructions for the indoor and outdoor units and make sure all accessory parts listed are with the system before beginning.

3.1. Type of copper pipe and insulation material

⚠ CAUTION

Refer to the installation manual of the outdoor unit for description of the length of connecting pipe or for difference of its elevation.

Gas pipe size (thickness) [mm]	Liquid pipe size (thickness) [mm]
Ø 15.88 (5/8 in.)	Ø 9.52 (3/8 in.)

⚠ CAUTION

- Wrap heat insulation around both of the gas pipe and the liquid pipe. No heat-insulation work or incorrect heat-insulation work may cause water leaks.
- In a reverse cycle model, use heat insulation with heat resistance above 120 °C.
- If expected humidity of the installation location of refrigerant pipes is higher than 70 %, wrap the heat insulation around the refrigerant pipes. If the expected humidity is between 70 % and 80 %, use heat insulation that has thickness of 15 mm or more. If the expected humidity is higher than 80 %, use heat insulation that has thickness of 20 mm or more.
- Using of thinner heat insulation than specified above may cause a condensation on the surface of the insulation.
- Use heat insulation with thermal conductivity of 0.045 W/(m·K) or less, at 20 °C.

3.2. Additional materials required for installation

- Refrigeration (armored) tape
- Insulated staples or clamps for connecting wire (See your local electrical codes.)
- Putty
- Refrigeration lubricant
- Clamps or saddles to secure refrigerant piping

4. ELECTRICAL REQUIREMENT

The indoor unit is powered from the outdoor unit. Do not power indoor unit from separate power source.

⚠ WARNING

Standard for electrical wiring and equipment differs in each country or region. Before you start electrical working, confirm related regulations, codes, or standards.

Cable	Conductor size [mm ²]	Type	Remarks
Connection cable	1.5	Type 60245 IEC 57	3 cable + Earth (Ground), 1 Ø 230 V

Max. Cable Length: Limit voltage drop to less than 2%. Increase cable gauge if voltage drop is 2% or more.

5. SELECTING THE MOUNTING POSITION

Decide the mounting position with the customer as follows:

5.1. Indoor unit

- (1) Install the indoor unit level on a strong wall which is not subject to vibration.
- (2) The inlet and outlet ports should not be obstructed : the air should be able to blow all over the room.
- (3) Install the unit a dedicated electrical branch circuit.
- (4) Do not install the unit where it will be exposed to direct sunlight.
- (5) Install the unit where connection to the outdoor unit is easy.
- (6) Install the unit where the drain pipe can be easily installed.
- (7) Take servicing, etc. into consideration and leave the spaces shown in "6.1. Installation dimensions". Also install the unit where the filter can be removed.

Correct initial installation location is important because it is difficult to move the unit after it is installed.

WARNING

Install the indoor unit where is capable to support the weight of the unit. Secure the unit firmly so that the unit does not topple or fall.

CAUTION

Do not install the unit in the following areas:

- Area with high salt content, such as at the seaside. It will deteriorate metal parts, causing the parts to fail or the unit to leak water.
 - Area filled with mineral oil or containing a large amount of splashed oil or steam, such as a kitchen. It will deteriorate plastic parts, causing the parts to fail or the unit to leak water.
 - Area where is close to heat sources.
 - Area that generates substances that adversely affect the equipment, such as sulfuric gas, chlorine gas, acid, or alkali. It will cause the copper pipes and brazed joints to corrode, which can cause refrigerant leakage.
 - Area that can cause combustible gas to leak, contains suspended carbon fibers or flammable dust, or volatile in flammables such as paint thinner or gasoline.
 - If gas leaks and settles around the unit, it can cause a fire.
 - Area where animals may urinate on the unit or ammonia may be generated.
- Do not use the unit for special purposes, such as storing food, raising animals, growing plants, or preserving precision devices or art objects. It can degrade the quality of the preserved or stored objects.
 - Install the unit where drainage does not cause any trouble.
 - Install the indoor unit, outdoor unit, power supply cable, transmission cable, and remote control cable at least 1 m away from a television or radio receivers. The purpose of this is to prevent TV reception interference or radio noise. (Even if they are installed more than 1 m apart, you could still receive noise under some signal conditions.)
 - If children under 10 years old may approach the unit, take preventive measures so that they cannot reach the unit.
 - Install the indoor unit on the wall where the height from the floor is more than 1.8 m.

6. INSTALLATION WORK

CAUTION

- Do not hit or push the human sensor. This may lead to damage or malfunction.
- Do not touch the human sensor. Any scratches or dirt may lead to incorrect detection.
- Do not place large objects near the human sensor. Also keep heating units outside the sensor's detection area.

Detection range of the human sensor is as follows.

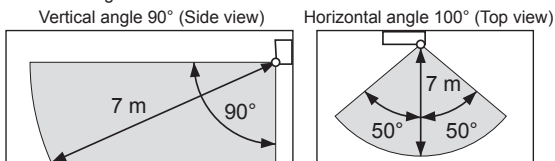

6.1. Installation dimensions

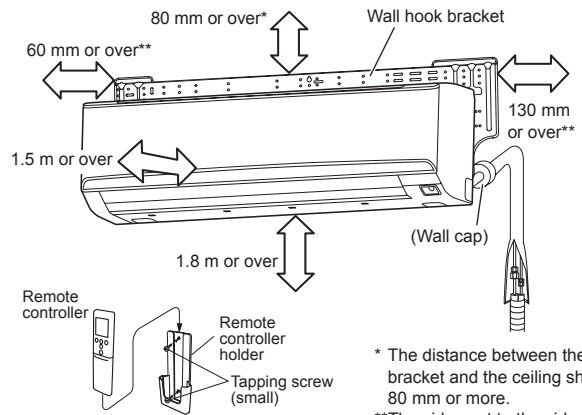

* The distance between the wall hook bracket and the ceiling should be 80 mm or more.

**The side next to the sidewall must follow the size indicated in figure.

6.2. Indoor unit piping direction

The piping can be connected in the 7 directions in the figure. When the piping is connected in direction (B), (C), (D) or (E), cut along the piping groove in the side of the front panel with a hacksaw.

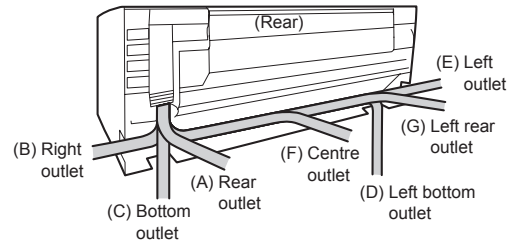

6.3. Cutting the hole in the wall for the connecting piping

- (1) Cut a 80 mm diameter hole in the wall at the position shown in the following.
- (2) Cut the hole so that the outside end is lower (5 to 10 mm) than the inside end.
- (3) Always align the center of the wall hole. If misaligned, water leakage will occur.
- (4) Cut the wall pipe to match the wall thickness, stick it into the wall cap, fasten the cap with vinyl tape, and stick the pipe through the hole.
- (5) For left piping and right piping, cut the hole a little lower so that drain water will flow freely.

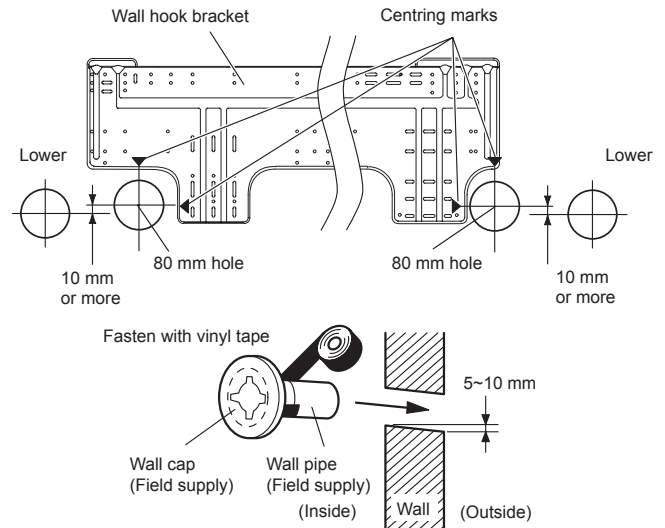

WARNING

Always use the wall pipe. If the wall pipe is not used, the cable that is connected between the indoor unit and the outdoor unit may touch metal, and cause an electric discharge.

6.4. Installing the wall hook bracket

- Install the wall hook bracket so that it is correctly positioned horizontally and vertically. If the wall hook bracket is tilted, water will drip to the floor.
- Install the wall hook bracket so that it is strong enough to support the weight of the unit.
 - Fasten the wall hook bracket to the wall with 5 or more screws through the holes near the outer edge of the bracket.
 - Check that there is no rattle at the wall hook bracket.

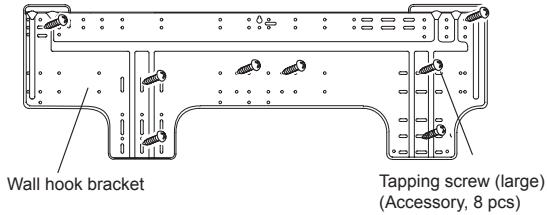

CAUTION

Install the wall-hook bracket both horizontally and vertically aligned. Misaligned installation may cause water leakage.

6.5. Forming the drain hose and pipe

CAUTION

- Insert drain hose and drain cap securely. Drain should slope down to avoid water leakage.
- When inserting the drain hose, no other material than water should be applied. Application of other material than water will cause deterioration of the hose, and may cause water leakage.
- After you remove a drain hose, be sure to attach the drain cap.
- When you secure the piping and drain hose with tape, arrange the drain hose so that it is at the bottom of the piping.
- For drain hose piping in low temperature environment, you need to apply freeze protection to prevent a frozen drain hose. After cooling operation is performed in low temperature environment, (when outdoor temperature under 0 °C,) water in the drain hose could be frozen. Frozen drain water will block the water flow in the hose, and may cause water leakage at the indoor unit.

[Rear piping, Right piping, Bottom piping]

- Install the indoor unit piping in the direction of the wall hole and bind the drain hose and pipe together with vinyl tape.
- Install the piping so that the drain hose is at the bottom.
- Wrap the pipes of the indoor unit that are visible from the outside with decorative tape.

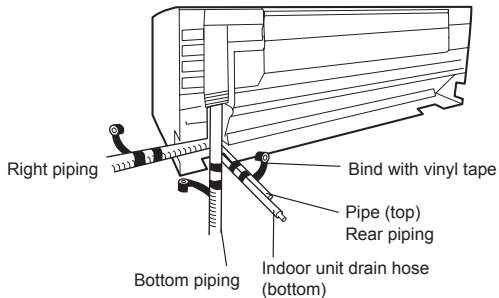

[For Left rear piping, Left piping]

Interchange the drain cap and the drain hose.

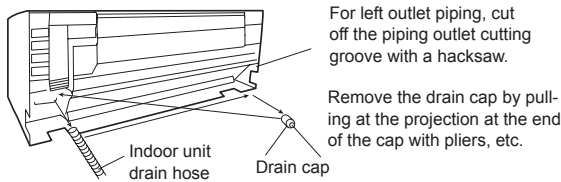

Installing the Drain cap

Use a hexagonal wrench 4 mm at opposite side to insert the drain cap, till the drain cap contacts the tip of the drain cock.

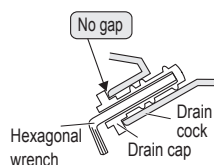

CAUTION

Insert the drain hose and drain cap into the drain port, making sure that it comes in contact with the back of the drain port, and then mount it. If the drain hose is not connected properly, leaking will occur.

- For left piping and left rear piping, align the marks on the wall hook bracket and shape the connection pipe.
- Bend the connection piping at the bend radius of 100 mm or more and install no more than 35 mm from the wall.
- After passing the indoor piping and drain hose through the wall hole, hang the indoor unit on the hooks at the top and bottom of the wall hook bracket.

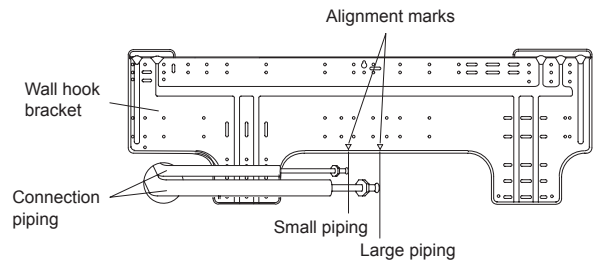

[Installing the indoor unit]

- Hang the indoor unit from the hooks at the top of the wall hook bracket.
- Insert the spacer, etc. between the indoor unit and the wall hook bracket and separate the bottom of the indoor unit from the wall.

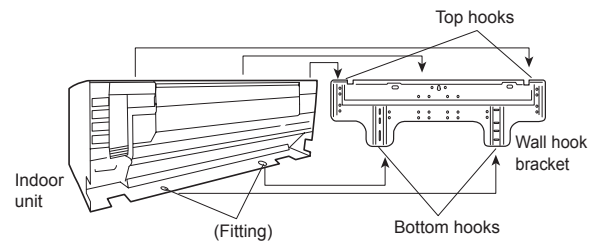
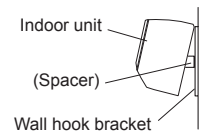

- After hooking the indoor unit to the top hook, hook the fittings of the indoor unit to the 2 bottom hooks while lowering the unit and pushing it against the wall.

6.6. Flare connection (Pipe connection)

CAUTION

Tighten the flare nuts with a torque wrench using the specified tightening method. Otherwise, the flare nuts could break after a prolonged period, causing refrigerant to leak and generate hazardous gas if the refrigerant comes into contact with a flame.

6.6.1. Flaring

Use special pipe cutter and flare tool designed for R410A pipework.

- Cut the connection pipe to the necessary length with a pipe cutter.
- Hold the pipe downward so that cuttings will not enter the pipe and remove any burrs.
- Insert the flare nut (always use the flare nut attached to the indoor unit(s) and outdoor unit or branch box respectively) onto the pipe and perform the flare processing with a flare tool. Use the special R410A flare tool, or the conventional flare tool. Leakage of refrigerant may result if other flare nuts are used.
- Protect the pipes by pinching them or with tape to prevent dust, dirt, or water from entering the pipes.

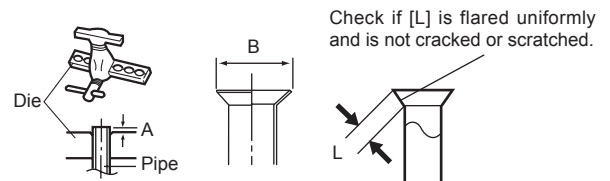

Pipe outside diameter [mm (in.)]	Dimension A [mm]	Dimension B [mm]
	Flare tool for R410A, clutch type	
6.35 (1/4)	0 to 0.5	9.1
9.52 (3/8)		13.2
12.70 (1/2)		16.6
15.88 (5/8)		19.7
19.05 (3/4)		24.0

When using conventional flare tools to flare R410A pipes, the dimension A should be approximately 0.5 mm more than indicated in the table (for flaring with R410A flare tools) to achieve the specified flaring. Use a thickness gauge to measure the dimension A.

Width across flats

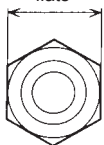

Pipe outside diameter [mm (in.)]	Width across flats of Flare nut [mm]
6.35 (1/4)	17
9.52 (3/8)	22
12.70 (1/2)	26
15.88 (5/8)	29
19.05 (3/4)	36

6.6.2. Bending pipes

CAUTION

To prevent breaking of the pipe, avoid sharp bends.

If the pipe is bent repeatedly at the same place, it will break.

- The pipes are shaped by your hands. Be careful not to collapse them.
- Bend R70 mm or more with a pipe bender.
- Do not bend the pipes in an angle more than 90°.
- When pipes are repeatedly bent or stretched, the material will harden, making it difficult to bend or stretch them any more.
- Do not bend or stretch the pipes more than 3 times.
- When bending the pipe, do not bend it as is. The pipe will be collapsed. In this case, cut the insulating pipe with a sharp cutter as shown on the right, and bend it after exposing the pipe. After bending the pipe as you want, be sure to put the heat insulating pipe back on the pipe, and secure it with tape.

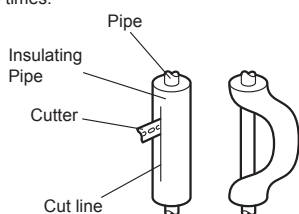

6.6.3. Pipe connection

CAUTION

Be sure to install the pipe against the port on the indoor unit correctly. If the centering is improper, the flare nut cannot tighten smoothly. If the flare nut is forced to turn, the threads will be damaged.

Do not remove the flare nut from the indoor unit pipe until immediately before connecting the connection pipe.

Hold the torque wrench at its grip, keeping it in the right angle with the pipe, in order to tighten the flare nut correctly.

Tighten the flare nuts with a torque wrench using the specified tightening method. Otherwise, the flare nuts could break after a prolonged period, causing refrigerant to leak and generate hazardous gas if the refrigerant comes into contact with a flame.

Connect the piping so that the control box cover can easily be removed for servicing when necessary.

In order to prevent water from leaking into the control box, make sure that the piping is well insulated.

When the flare nut is tightened properly by your hand, hold the body side coupling with a wrench, then tighten with a torque wrench. (See the table below for the flare nut tightening torques.)

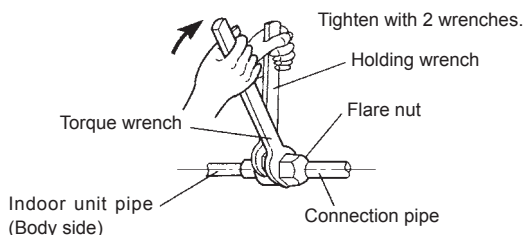

Flare nut [mm (in.)]	Tightening torque [N·m (kgf·cm)]
6.35 (1/4) dia.	16 to 18 (160 to 180)
9.52 (3/8) dia.	32 to 42 (320 to 420)
12.70 (1/2) dia.	49 to 61 (490 to 610)
15.88 (5/8) dia.	63 to 75 (630 to 750)
19.05 (3/4) dia.	90 to 110 (900 to 1,100)

Do not remove the cap from the connection pipe before connecting the pipe.

7. ELECTRICAL WIRING

CAUTION

Be careful not to generate a spark as follows for using a flammable refrigerant.

- Do not remove the fuse while the power is on.
- Do not disconnect the wiring while the power is on.
- It is recommended to position the outlet connection in a high position. Place the cords so that they do not get tangled.

7.1. Wiring system diagram

WARNING

- Before connecting the wires, make sure the power supply is OFF.
- Every wire must be connected firmly.
- No wire should be allowed to touch refrigerant tubing, the compressor, or any moving part.
- Loose wiring may cause the terminal to overheat or result in unit malfunction. A fire hazard may also exist. Therefore, be sure all wiring is tightly connected.
- Connect wires to the matching numbers of terminals.

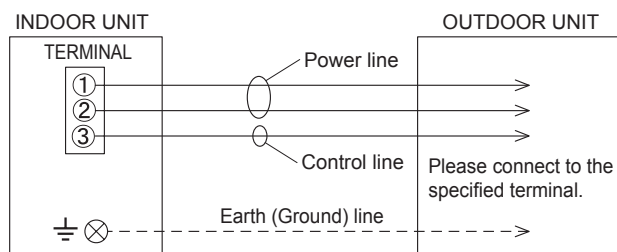

7.2. Indoor unit wiring

- Open the intake grille. Remove the tapping screw for the wire cover and remove the wire cover.

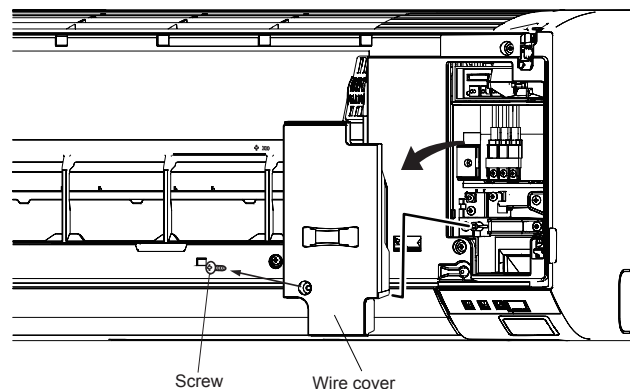

- (2) Remove the tapping screw and while minding the cable clamp hook, remove the cable clamp.

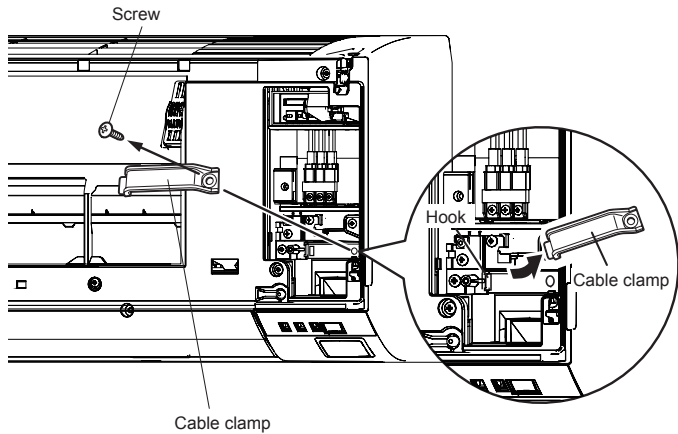

- (3) Connect the end of the connection cable fully into the terminal block.

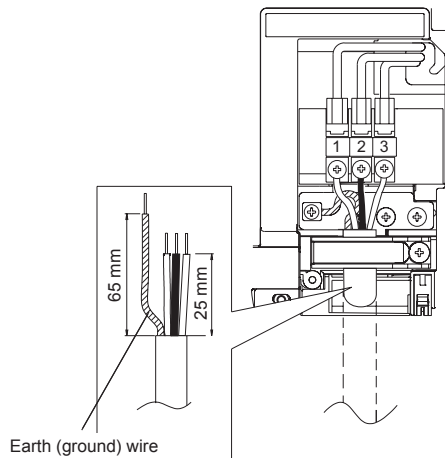

7.3. How to connect wiring to the terminals

Caution when wiring cable

To strip off the insulation of a lead wire, always use a special tool such as a wire stripper. If there is no special tool, carefully strip off the insulation by using a knife or other utensil.

- Use ring terminals with insulating sleeves as shown in the figure to connect to the terminal block.
- Securely clamp the ring terminals to the wires by using an appropriate tool so that the wires do not come loose.

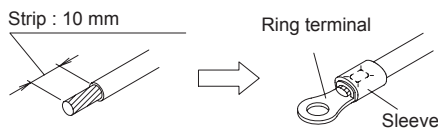

- Connect specified wires securely, and fasten them so that there is no stress applied on the terminals.
- Use a screwdriver with an appropriate bit size to tighten the terminal screws. Using of screwdriver with inappropriate bit size will damage the screw heads, and the screws will not be tightened properly.
- Do not overtighten the terminal screws. Otherwise, the screws may break.

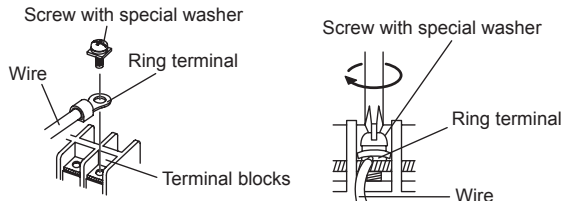

- (6) See the table for the terminal screw tightening torques.

Tightening torque [N·m (kgf·cm)]	
M4 screw	1.2 to 1.8 (12 to 18)

CAUTION

- Match the terminal block numbers and connection cable colors with those of the outdoor unit. Incorrect wiring may cause a fire.
- Connect the connection cables firmly to the terminal block. Imperfect installation may cause a fire.
- When fixing the connection cable with the cable clamp, always fasten the cable at the plastic jacket portion, but not at the insulator portion. If the insulator is chafed, electric leakage may occur.
- Always connect the earth (ground) wire. Improper earthing (grounding) work can cause electric shocks.
- Do not use the earth (ground) screw for the indoor unit to the outdoor unit unless it is specified.

8. FINISHING

- Insulate between pipes.
 - Insulate suction and discharge pipes separately.
 - For rear, right, and bottom piping, overlap the connection pipe heat insulation and indoor unit pipe heat insulation and bind them with vinyl tape so that there is no gap.
- Temporarily fasten the connection cable along the connection pipe with vinyl tape. (Wrap to about 1/3 the width of the tape from the bottom of the pipe so that water does not enter.)
- Fasten the connection pipe to the outside wall with a saddle, etc.
- Fill the gap between the outside wall pipe hole and the pipe with sealer so that rain water and wind cannot blow in.
- Fasten the drain hose to the outside wall, etc.

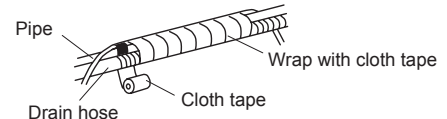
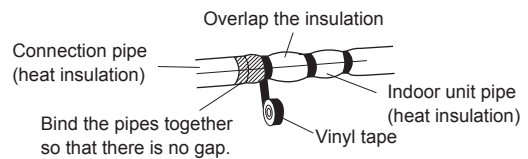
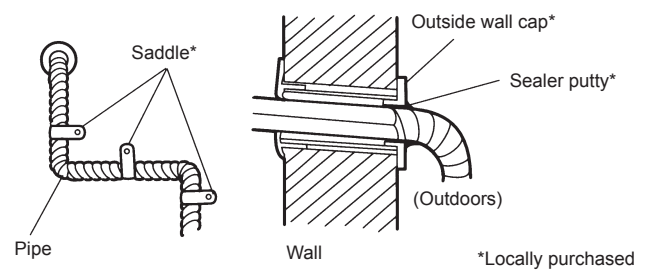

Drain hose insulation is used when the diameter of gas pipe is $\varnothing 12.70$ or more.

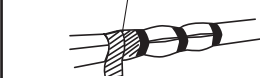

Butt connection pipe (heat insulation) against the indoor unit pipe (heat insulation) and wrap with drain hose insulation so that there is no gap.

Check the following:

GOOD

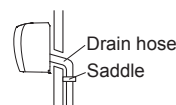

PROHIBITED

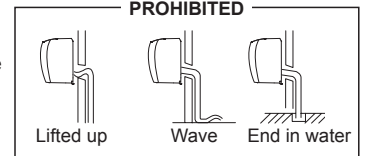

9. FRONT PANEL REMOVAL AND INSTALLATION

Intake grille removal

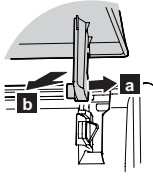

Open the intake grille. While gently pressing the left and right mounting shafts of the intake grille outward "a", remove the intake grille in direction of the arrow "b".

Intake grille installation

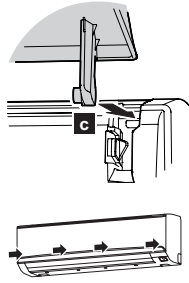

While holding the grille horizontal, set the left and right mounting shafts into the pillow blocks at the top of the panel "c". To latch each shaft properly, insert the shaft until it snaps. Press 4 places on the intake grille to close it completely.

9.1. Front panel removal

- (1) Remove intake grille (Reference the intake grille removal.)
- (2) Remove 4 caps.
- (3) Remove wire cover.
- (4) Remove 10 screws.

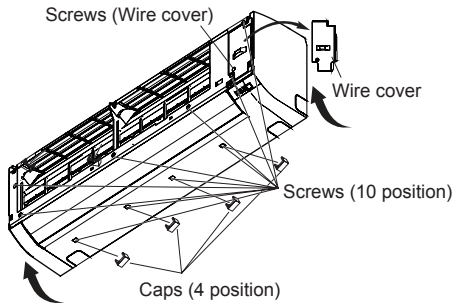

NOTE : When replacing the front panel, do not scratch or damage the louver.

- (5) The front panel is pulled to the front, raising the upper surface, then the front panel is removed.

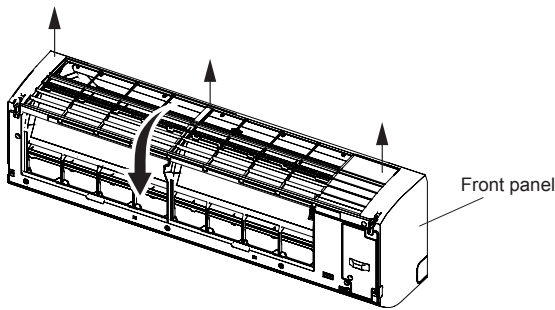

9.2. Front panel installation

- (1) First, fit the lower part of the front panel, and insert top and middle hooks. (3 top sides, 5 middles)

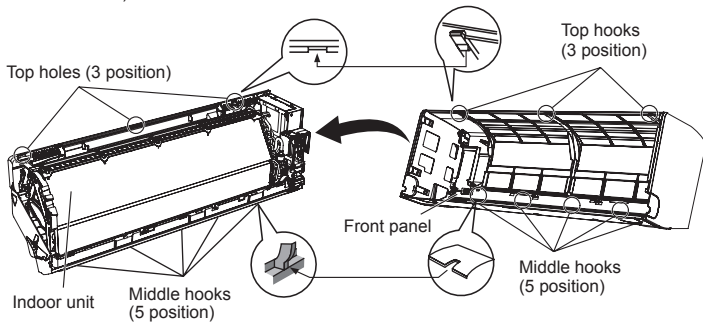

- (2) Attach the 10 screws.
- (3) Attach the wire cover.
- (4) Attach the 4 caps.
- (5) Attach the intake grille.

CAUTION

Install the front panel and intake grille securely. If installation is imperfect, the front panel or intake grille may fall off and cause injury.

10. TEST RUN

Check items

- (1) Is operation of each button on the remote control unit normal?
 - (2) Does each lamp light normally?
 - (3) Do air flow direction louvers operate normally?
 - (4) Is the drain normal?
 - (5) Do not have an abnormal noise and vibration during operation?
- Do not operate the air conditioner in test run for a long time.

[Operation method]

- For the operation method, refer to the operating manual.
- The outdoor unit, may not operate, depending on the room temperature. In this case, keep on pressing the "MANUAL AUTO" button of the indoor unit for more than 10 seconds. The OPERATION indicator lamp and TIMER indicator lamp will begin to flash simultaneously during cooling test run. Then, heating test run will begin in about 3 minutes when HEAT is selected by the remote controller operation [reverse cycle model only]. (Please follow the operating manual for remote controller operation.)
- To end test operation, press the remote controller "Start/Stop(⏻)" button. (When the air conditioner is running by pressing the "TEST RUN" button, the OPERATION Lamp and TIMER Lamp will simultaneously flash slowly.)

11. REMOTE CONTROLLER INSTALLATION

Check that the indoor unit correctly receives the signal from the remote controller, then install the remote controller holder.

CAUTION

Do not install the remote controller holder in the following conditions:

- Any places exposed in direct sunlight
- Positions affected by the heat from a stove or heater

11.1. Remote controller holder installation

- Install the remote controller a maximum distance of 7 m from the remote control signal receiver. After installing the remote controller, check that it operates correctly.
- Install the remote controller holder to a wall, pillar, etc. with the tapping screw.

Remote controller holder fixing

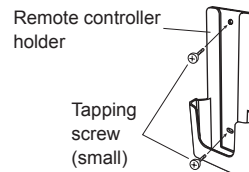

Remote controller mounting

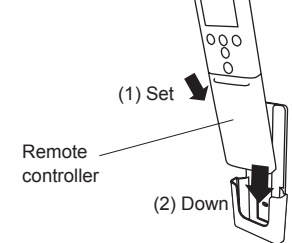

12. OPTIONAL KIT INSTALLATION

This air conditioner can be connected with the following optional kits.

- Wired remote controller
- Simple remote controller
- External connect kit
- External input and output PCB

13. SELECTING THE REMOTE CONTROLLER CUSTOM CODE

When two or more air conditioners are installed in a room and the remote controller is operating an air conditioner other than the one you wish to set, change the custom code of the remote controller to operate only the air conditioner you wish to set (4 selections possible).

When two or more air conditioners are installed in a room, please contact your retailer to set the individual air conditioner custom codes.

Selecting the Remote Controller Custom Code

Use the following steps to select the custom code of the remote controller. (Note that the air conditioner cannot receive a signal if the air conditioner has not been set for the matching custom code.)

- Press the "Start/Stop(⏻)" button until only the clock is displayed on the remote controller display.
- Press the "MODE" button for at least 5 seconds to display the current custom code (initially set to A).
- Press the "TEMP." (∧ / ∨) buttons to change the custom code between A→B→C→D. Match the code on the display to the air conditioner custom code.
- Press the "MODE" button again to return to the clock display. The custom code will be changed.

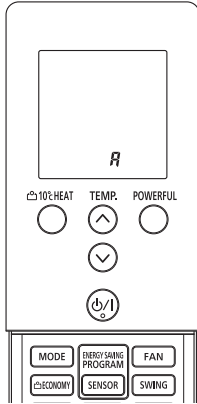

- If no buttons are pressed within 30 seconds after the custom code is displayed, the system returns to the original clock display. In this case, start again from step 1.
- The air conditioner custom code is set to A prior to shipment.

14. FUNCTION SETTING

Perform the "FUNCTION SETTING" according to the installation conditions using the remote controller.

CAUTION

- Confirm whether the wiring work for outdoor unit has been finished.
- Confirm that the cover for the electrical enclosure on the outdoor unit is in place.

- This procedure changes to the function settings used to control the indoor unit according to the installation conditions. Incorrect settings can cause the indoor unit to malfunction.
- After the power is turned on, perform the "FUNCTION SETTING" according to the installation conditions using the remote controller.
- The settings may be selected between the following two: Function Number or Setting Value.
- Settings will not be changed if invalid numbers or setting values are selected.
- Refer to the installation manual enclosed with the remote control unit when the wired remote control unit (option) is used.

Entering the Function Setting Mode

While pressing the "POWERFUL" button and "TEMP." (∧) button simultaneously, press the "RESET" button to enter the function setting mode.

Selecting the Function Number and Setting Value [Reverse cycle model]

- Press the "TEMP." (∧ / ∨) buttons to select the function number. (Press the "10°C HEAT" button to switch between the left and right digits.)
- Press the "POWERFUL" button to proceed to setting value. (Press the "POWERFUL" button again to return to the function number selection.)
- Press the "TEMP." (∧ / ∨) buttons to select the setting value. (Press the "10°C HEAT" button to switch between the left and right digits.)
- Press the "MODE" button once to send the function setting information. Please confirm the beeping sound.
- Next, please press "Start/Stop(⏻)" button once to fix the function setting. Please confirm the beeping sound.
- Press the "RESET" button to cancel the function setting mode.
- After completing the FUNCTION SETTING, be sure to turn off the power and turn it on again.

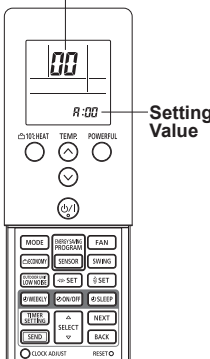

Selecting the Function Number and Setting Value [Cool model]

- Press the "TEMP." (∧ / ∨) buttons to select the function number. (Press the "ECONOMY" button to switch between the left and right digits.)
- Press the "POWERFUL" button to proceed to setting value. (Press the "POWERFUL" button again to return to the function number selection.)
- Press the "TEMP." (∧ / ∨) buttons to select the setting value. (Press the "ECONOMY" button to switch between the left and right digits.)
- Press the "MODE" button once to send the function setting information. Please confirm the beeping sound.
- Next, please press "Start/Stop(⏻)" button once to fix the function setting. Please confirm the beeping sound.
- Press the "RESET" button to cancel the function setting mode.
- After completing the FUNCTION SETTING, be sure to turn off the power and turn it on again.

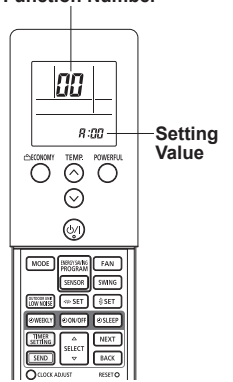

CAUTION

After turning off the power, wait 30 seconds or more before turning it on again. The function setting does not become active unless the power is turned off then on again.

Remote controller address setting

* Because this setting is normally done automatically when 2-wire-type wired remote controller is installed, setting is unnecessary.

Multiple indoor units can be operated by using one wired remote controller. Set the unit number of each indoor unit.

(... Factory setting)

Setting Description	Function Number	Setting Value
Unit no. 0	00	00
Unit no. 1		01
Unit no. 2		02
Unit no. 3		03
Unit no. 4		04
Unit no. 5		05
Unit no. 6		06
Unit no. 7		07
Unit no. 8		08
Unit no. 9		09
Unit no. 10		10
Unit no. 11		11
Unit no. 12		12
Unit no. 13		13
Unit no. 14		14
Unit no. 15	15	

* When connecting Polar 3-core wired remote controller, set the remote controller address in the order of 0, 1, 2, ..., and 15.

* When different type of indoor units (such as wall-mounted type and cassette type, cassette type and duct type, or other combinations) are connected using group control system, some functions may no longer be available.

Filter sign

Select appropriate intervals for displaying the filter sign on the indoor unit according to the estimated amount of dust in the air of the room.

If the indication is not required, select "No indication" (03).

(... Factory setting)

Setting Description	Function Number	Setting Value
Standard (400 hours)	11	00
Long interval (1,000 hours)		01
Short interval (200 hours)		02
No indication		03

Room temperature control for indoor unit sensor

Depending on the installed environment, correction of the room temperature sensor may be required. Select the appropriate control setting according to the installed environment. The temperature correction values show the difference from the Standard setting "00" (manufacturer's recommended value).

(◆... Factory setting)

Setting Description	Function Number	Setting Value
◆ Standard setting	30 (For cooling)	00
No correction 0.0 °C		01
-0.5 °C		02
-1.0 °C		03
-1.5 °C		04
-2.0 °C		05
-2.5 °C		06
-3.0 °C		07
-3.5 °C		08
-4.0 °C		09
+0.5 °C		10
+1.0 °C		11
+1.5 °C		12
+2.0 °C		13
+2.5 °C		14
+3.0 °C		15
+3.5 °C		16
+4.0 °C	17	

Room temperature control for wired remote controller sensor

Depending on the installed environment, correction of the wire remote temperature sensor may be required. Select the appropriate control setting according to the installed environment. To change this setting, set Function 42 to Both "01".

Ensure that the Thermo Sensor icon is displayed on the remote controller screen.

(◆... Factory setting)

Setting Description	Function Number	Setting Value
◆ No correction	35 (For cooling)	00
No correction 0.0 °C		01
-0.5 °C		02
-1.0 °C		03
-1.5 °C		04
-2.0 °C		05
-2.5 °C		06
-3.0 °C		07
-3.5 °C		08
-4.0 °C		09
+0.5 °C		10
+1.0 °C		11
+1.5 °C		12
+2.0 °C		13
+2.5 °C		14
+3.0 °C		15
+3.5 °C		16
+4.0 °C	17	

Auto restart

Enable or disable automatic restart after a power interruption.

(◆... Factory setting)

Setting Description	Function Number	Setting Value
◆ Enable	40	00
Disable		01

* Auto restart is an emergency function such as for power outage etc. Do not attempt to use this function in normal operation. Be sure to operate the unit by remote controller or external device.

Room temperature sensor switching

(Only for wired remote controller)

When using the Wired remote controller temperature sensor, change the setting to "Both" (01).

(◆... Factory setting)

Setting Description	Function Number	Setting Value
◆ Indoor unit	42	00
Both		01

00: Sensor on the indoor unit is active.

01: Sensors on both indoor unit and wired remote controller are active.

* Remote controller sensor must be turned on by using the remote controller.

Remote controller custom code

(Only for wireless remote controller)

The indoor unit custom code can be changed. Select the appropriate custom code.

(◆... Factory setting)

Setting Description	Function Number	Setting Value
◆ A	44	00
B		01
C		02
D		03

External input control

"Operation/Stop" mode or "Forced stop" mode can be selected.

(◆... Factory setting)

Setting Description	Function Number	Setting Value
◆ Operation/Stop mode1	46	00
(Setting forbidden)		01
Forced stop mode		02
Operation/Stop mode 2		03

Room temperature sensor switching (Aux.)

To use the temperature sensor on the wired remote controller only, change the setting to "Wired remote controller" (01).

This function will only work if the function setting 42 is set at "Both" (01).

(◆... Factory setting)

Setting Description	Function Number	Setting Value
◆ Both	48	00
Wired remote controller		01

Indoor unit fan control for energy saving for cooling

Enables or disables the power-saving function by controlling the indoor unit fan rotation when the outdoor unit is stopped during cooling operation.

(◆... Factory setting)

Setting Description	Function Number	Setting Value
◆ Disable	49	00
Enable		01
Remote controller		02

00: When the outdoor unit is stopped, the indoor unit fan operates continuously following the setting on the remote controller.

01: When the outdoor unit is stopped, the indoor unit fan operates intermittently at a very low speed.

02: Enable or disable this function by remote controller setting.

* As the factory setting, this setting is initially activated.

* When connecting VRF system using network converter, this setting must be set to "00" or "01".

Switching functions for external output terminal

Functions of the external output terminal can be switched. For details, refer to "External input and output".

(◆... Factory setting)

Setting Description	Function Number	Setting Value
◆ Operation status	60	00
Error status		09
Indoor unit fan operation status		10
Set point attainment status		12

Server room control switching

Switches between normal control and server room control.

To use this function, address setting of the primary unit and secondary unit needs to be done.

(◆... Factory setting)

Setting Description	Function Number	Setting Value
◆ Normal control	96	00
Server room control (Primary unit)		01
Server room control (Secondary unit)		02

Setting record

Record any changes to the settings in the following table.

Setting Description	Setting Value
Remote controller address setting	
Filter sign	
Room temperature control for indoor unit sensor	Cooling Heating
Room temperature control for wired remote controller sensor	Cooling Heating
Auto restart	
Room temperature sensor switching	
Remote controller custom code	
External input control	
Room temperature sensor switching (Aux.)	
Indoor unit fan control for energy saving for cooling	
Switching functions for external output terminal	
Server room control switching	

After completing the FUNCTION SETTING, be sure to turn off the power and turn it on again.

15. CUSTOMER GUIDANCE

Explain the following to the customer in accordance with the operating manual:

- (1) Starting and stopping method, operation switching, temperature adjustment, timer, air flow switching, and other remote control unit operations.
- (2) Air filter removal and cleaning, and how to use the air louvers.
- (3) Give the operating manual to the customer.

16. ERROR CODES

If you use a wireless remote controller, the lamp on the photo detector unit will output error codes by way of blinking patterns. If you use a wired remote controller, error codes will appear on the remote control display. See the lamp blinking patterns and error codes in the table. An error display is displayed only during operation.

Error display			Wired remote controller Error code	Description
OPERATION lamp (green)	TIMER lamp (orange)	ECONOMY lamp (green)		
●(1)	●(1)	◇	11	Serial communication error
●(1)	●(2)	◇	12	• Wired remote controller communication error • Server room control communication error
●(1)	●(5)	◇	15	Check run unfinished
●(1)	●(6)	◇	16	Peripheral unit transmission PCB connection error
●(2)	●(1)	◇	21	Unit number or Refrigerant circuit address setting error [Simultaneous Multi]
●(2)	●(2)	◇	22	Indoor unit capacity error
●(2)	●(3)	◇	23	Combination error
●(2)	●(4)	◇	24	• Connection unit number error (indoor slave unit) [Simultaneous Multi] • Connection unit number error (indoor unit or branch unit) [Flexible Multi]
●(2)	●(6)	◇	26	Address setting error in wired remote controller system
●(2)	●(7)	◇	27	Master unit, slave unit set-up error [Simultaneous Multi]
●(3)	●(2)	◇	32	Indoor unit PCB model information error
●(3)	●(5)	◇	35	Manual auto switch error
●(4)	●(1)	◇	41	Room temp. sensor error
●(4)	●(2)	◇	42	Indoor unit Heat Ex. Middle temp. sensor error
●(5)	●(1)	◇	51	Indoor unit fan motor error
●(5)	●(3)	◇	53	Drain pump error
●(5)	●(7)	◇	57	Damper error
●(5)	●(8)	◇	58	Intake grille error
●(5)	●(15)	◇	5U	Indoor unit error
●(6)	●(2)	◇	62	Outdoor unit main PCB model information error or communication error
●(6)	●(3)	◇	63	Inverter error
●(6)	●(4)	◇	64	Active filter error, PFC circuit error
●(6)	●(5)	◇	65	Trip terminal L error
●(6)	●(10)	◇	6A	Display PCB microcomputers communication error

●(7)	●(1)	◇	71	Discharge temp. sensor error
●(7)	●(2)	◇	72	Compressor temp. sensor error
●(7)	●(3)	◇	73	Outdoor unit Heat Ex. liquid temp. sensor error
●(7)	●(4)	◇	74	Outdoor temp. sensor error
●(7)	●(5)	◇	75	Suction Gas temp. sensor error
●(7)	●(6)	◇	76	• 2-way valve temp. sensor error • 3-way valve temp. sensor error
●(7)	●(7)	◇	77	Heat sink temp. sensor error
●(8)	●(2)	◇	82	• Sub-cool Heat Ex. gas inlet temp. sensor error • Sub-cool Heat Ex. gas outlet temp. sensor error
●(8)	●(3)	◇	83	Liquid pipe temp. sensor error
●(8)	●(4)	◇	84	Current sensor error
●(8)	●(6)	◇	86	• Discharge pressure sensor error • Suction pressure sensor error • High pressure switch error
●(9)	●(4)	◇	94	Trip detection
●(9)	●(5)	◇	95	Compressor rotor position detection error
●(9)	●(7)	◇	97	Outdoor unit fan motor error
●(9)	●(9)	◇	99	4-way valve error
●(10)	●(1)	◇	A1	Discharge temp. error
●(10)	●(3)	◇	A3	Compressor temp. error
●(10)	●(4)	◇	A4	High pressure error
●(10)	●(5)	◇	A5	Low pressure error
●(13)	●(2)	◇	J2	Branch boxes error [Flexible Multi]

Display mode ● : 0.5s ON / 0.5s OFF
◇ : 0.1s ON / 0.1s OFF
() : Number of flashing

[Troubleshooting with the indoor unit display]

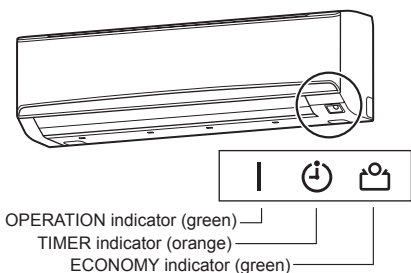

[Troubleshooting with the Wired Remote Controller Display (Option)]

If an error occurs, the following display will be shown. ("Er" will appear in the set room temperature display.)

