

# AIR CONDITIONER

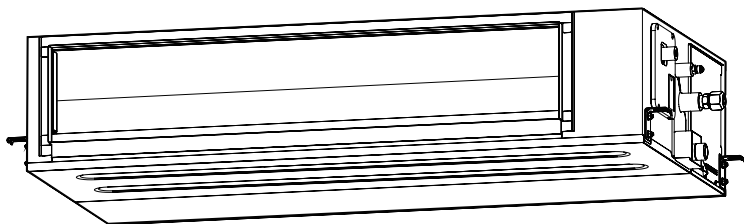

## INSTALLATION MANUAL

Indoor Unit (Duct type)  
For authorized service personnel only.

English

## INSTALLATIONSANLEITUNG

Innengerät (Für Luftkanalsysteme)  
Nur für autorisiertes Fachpersonal.

Deutsch

## MANUEL D'INSTALLATION

Unité intérieure (Type conduit)  
Pour le personnel de service agréé uniquement.

Français

## MANUAL DE INSTALACIÓN

Unidad interior (Tipo ducto)  
Únicamente para personal de servicio autorizado.

Español

## MANUALE D'INSTALLAZIONE

Unità interna (Tipo di condotto)  
A uso esclusivo del personale tecnico autorizzato.

Italiano

## ΕΓΧΕΙΡΙΔΙΟ ΕΓΚΑΤΑΣΤΑΣΗΣ

Εσωτερική μονάδα (Τύπος αγωγού)  
Μόνο για εξουσιοδοτημένο τεχνικό προσωπικό.

Ελληνικά

## MANUAL DE INSTALAÇÃO

Unidade interior (Tipo conduta)  
Somente para o pessoal do serviço técnico autorizado.

Português

## РУКОВОДСТВО ПО УСТАНОВКЕ

Внутренний модуль (Канального типа)  
Только для авторизованного обслуживающего персонала.

Русский

## KURULUM KILAVUZU

İç Ünite (Kanal tipi)  
Yalnızca yetkili servis personeli için.

Türkçe

[Original instructions]



PART No. 9381386116

# INSTALLATION MANUAL

PART No. 9381386116

Indoor Unit (Duct type)

## Contents

1. SAFETY PRECAUTIONS .....	1
2. ABOUT THIS PRODUCT .....	1
2.1. Precautions for using R410A refrigerant .....	1
2.2. Special tools for R410A refrigerant .....	1
2.3. Accessories .....	2
2.4. Optional parts .....	2
3. GENERAL SPECIFICATION .....	2
3.1. Selecting the pipe material .....	2
3.2. Pipe requirement .....	2
3.3. Electrical requirement .....	3
4. INSTALLATION WORK .....	3
4.1. Selecting an installation location .....	3
4.2. Installation dimension .....	3
4.3. Installing the unit .....	4
4.4. Installing the drain hose .....	5
4.5. Intake duct connection .....	6
4.6. Fresh air intake .....	6
5. PIPE INSTALLATION .....	6
5.1. Flare connection (pipe connection) .....	7
5.2. Installing heat insulation .....	7
6. ELECTRICAL WIRING .....	8
6.1. Wiring method .....	8
7. REMOTE CONTROLLER SETTING .....	9
8. FUNCTION SETTING .....	9
8.1. Function details .....	9
8.2. Static pressure .....	11
9. SPECIAL INSTALLATION METHODS .....	11
9.1. Group control system .....	11
9.2. Multiple remote control .....	12
9.3. Fan delay setting .....	12
10. OPTIONAL PARTS .....	12
10.1. Optional parts .....	12
10.2. External input and output .....	12
10.3. Remote sensor .....	13
11. CHECK LIST .....	13
12. TEST RUN .....	14
13. CUSTOMER GUIDANCE .....	14
14. ERROR CODES .....	14

Note: This manual describes how to install the air conditioner described above. Handling and installation shall only be done by professionals as outlined in this manual.

## 1. SAFETY PRECAUTIONS

- Be sure to read this manual thoroughly before installation.
- The warnings and precautions indicated in this manual contain important information pertaining to your safety. Be sure to observe them.
- Hand this manual, together with the operating manual, to the customer. Request the customer to keep them on hand for future use, such as for relocating or repairing the unit.

 <b>WARNING</b>	Indicates a potentially or imminently hazardous situation which, if not avoided, could result in death or serious injury.
Installation of this product must be done by experienced service technicians or professional installers only in accordance with this manual. Installation by nonprofessional or improper installation of the product may cause serious accidents such as injury, water leakage, electric shock, or fire. If the product is installed in disregard of the instructions in this manual, it will void the manufacturer's warranty.	
Do not turn on the power until all work has been completed. Turning on the power before the work is completed can cause serious accidents such as electric shock or fire.	
If refrigerant leaks when you are working, ventilate the area. If the leaking refrigerant is exposed to a direct flame it may produce a toxic gas.	
Do not use this equipment with air or any other unspecified refrigerant in the refrigerant lines. Excess pressure can cause a rupture.	
Installation must be performed in accordance with regulations, codes, or standards for electrical wiring and equipment in each country, region, or the installation place.	
This appliance is not intended for use by persons (including children) with reduced physical, sensory or mental capabilities, or lack of experience and knowledge, unless they have been given supervision or instruction concerning use of the appliance by a person responsible for their safety. Children should be supervised to ensure that they do not play with the appliance.	
To avoid danger of suffocation, keep the plastic bag or thin film used as the packaging material away from young children.	

 <b>CAUTION</b>	Indicates a potentially hazardous situation that may result in minor or moderate injury or damage to property.
Read carefully all safety information written in this manual before you install or use the air conditioner.	
Install the product by following local codes and regulations in force at the place of installation, and the instructions provided by the manufacturer.	
This product is part of a set constituting an air conditioner. The product must not be installed alone or be installed with non-authorized device by the manufacturer.	
Always use a separate power supply line protected by a circuit breaker operating on all wires with a distance between contact of 3 mm for this product.	
To protect the persons, earth (ground) the product correctly, and use the power cable combined with an Earth Leakage Circuit Breaker (ELCB).	
The product is not explosion proof, and therefore should not be installed in explosive atmosphere.	
To avoid getting an electric shock, never touch the electrical components soon after the power supply has been turned off. After turning off the power, always wait 5 minutes or more before you touch the electrical components.	
Do not touch the fins of the heat exchanger. Touching the heat exchanger fins could result in damage to the fins or personal injury such as skin rupture.	
This product contains no user-serviceable parts. Always consult experienced service technicians for repairing.	
When moving or relocating the air conditioner, consult experienced service technicians for disconnection and reinstallation of the product.	
Do not place any other electrical products or household belongings under the product. Condensation dripping from the product might get them wet, and may cause damage or malfunction of the property.	

## 2. ABOUT THIS PRODUCT

### 2.1. Precautions for using R410A refrigerant

 <b>WARNING</b>	Do not introduce any substance other than the prescribed refrigerant into the refrigeration cycle. If air enters the refrigeration cycle, the pressure in the refrigeration cycle will become abnormally high and cause the piping to rupture.
If there is a refrigerant leak, make sure that it does not exceed the concentration limit. If a refrigerant leak exceeds the concentration limit, it can lead to accidents such as oxygen starvation.	
Do not touch refrigerant that has leaked from the refrigerant pipe connections or other area. Touching the refrigerant directly can cause frostbite.	
If a refrigerant leak occurs during operation, immediately vacate the premises and thoroughly ventilate the area. If the refrigerant comes in contact with a flame, it produces a toxic gas.	

### 2.2. Special tools for R410A refrigerant

 <b>WARNING</b>	To install a unit that uses R410A refrigerant, use dedicated tools and piping materials that have been manufactured specifically for R410A use. Because the pressure of R410A refrigerant is approximately 1.6 times higher than the R22, failure to use dedicated piping material or improper installation can cause rupture or injury. Furthermore, it can cause serious accidents such as water leakage, electric shock, or fire.
--	--

















Tool name	Changes
Gauge manifold	The pressure in the refrigerant system is extremely high and cannot be measured with a conventional gauge. To prevent erroneous mixing of other refrigerants, the diameter of each port has been changed. It is recommended to use a gauge manifold with a high pressure display range of -0.1 to 5.3 MPa and a low pressure display range of -0.1 to 3.8 MPa.
Charging hose	To increase pressure resistance, the hose material and base size were changed. (The charging port thread diameter for R410A is 1/2-20 UNF.)
Vacuum pump	A conventional vacuum pump can be used by installing a vacuum pump adapter. Be sure that the pump oil does not backflow into the system. Use one capable for vacuum suction of -100.7 kPa (5 Torr, -755 mmHg).
Gas leakage detector	Special gas leakage detector for R410A refrigerant.

## 2.3. Accessories

### ⚠ WARNING

For installation purposes, be sure to use the parts supplied by the manufacturer or other prescribed parts.  
The use of non-prescribed parts can cause serious accidents such as the unit falling, water leakage, electric shock, or fire.

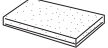
- The following installation parts are furnished. Use them as required.
- Keep the Installation Manual in a safe place and do not discard any other accessories until the installation work has been completed.

Name and Shape	Q'ty	Description
Operating Manual 	1	
Operating Manual (CD-ROM) 	1	
Operating Manual (For remote controller) 	1	
Installation Manual (indoor unit) 	1	(This book)
Installation Manual (remote controller) 	1	
Special nut A (large flange) 	4	For suspending the indoor unit from ceiling
Special nut B (small flange) 	4	
Washer 	8	
Coupler heat insulation (large) 	1	For indoor side pipe joint (gas pipe)
Coupler heat insulation (small) 	1	For indoor side pipe joint (liquid pipe)
Cable tie (large) 	4	For fixing the heat insulation
Cable tie (medium) 	1	For fixing the remote controller cable
Cable tie (small) 	1	For fixing the remote controller cable
Remote controller (WEC type) 	1	For air conditioner operation
Remote controller accessories	1 set	See installation manual for remote controller
Drain hose insulation 	1	Insulates the drain hose and vinyl hose
Drain hose 	1	For installing drain pipe VP25 (O.D.32, I.D.25)
Hose Band 	1	For installing drain hose

## 2.4. Optional parts

Parts name	Model No.	Summary
Wired Remote Controller	UTY-RVN*M	For air conditioner operation (3-wire type)
Wired Remote Controller	UTY-RNR*Z1	For air conditioner operation (2-wire type)
Simple remote controller	UTY-RSN*M	For air conditioner operation (3-wire type)
IR receiver unit	UTY-LBT*M	For air conditioner operation
Remote sensor	UTY-XSZX	Room temperature sensor
External input and output PCB	UTY-XCSX	For connecting external devices
External input and output PCB bracket	UTZ-GXNA	For installing the External input and output PCB
External connect kit	UTY-XWZXZG	For control output port
Air filter kit	UTD-LFNA	

## 3. GENERAL SPECIFICATION

### 3.1. Selecting the pipe material

#### ⚠ CAUTION

Do not use existing pipes.

Use pipes that have clean external and internal sides without any contamination which may cause trouble during use, such as sulfur, oxide, dust, cutting waste, oil, or water.

It is necessary to use seamless copper pipes.

Material : Phosphor deoxidized seamless copper pipes

It is desirable that the amount of residual oil is less than 40 mg/10 m.

Do not use copper pipes that have a collapsed, deformed, or discolored portion (especially on the interior surface). Otherwise, the expansion valve or capillary tube may become blocked with contaminants.

Improper pipe selection will degrade performance. As an air conditioner using R410A incurs pressure higher than when using conventional refrigerant, it is necessary to choose adequate materials.

- Thicknesses of copper pipes used with R410A are as shown in the table.
- Never use copper pipes thinner than those indicated in the table even if they are available on the market.

Pipe outside diameter [mm (in.)]	Thickness [mm]
6.35 (1/4)	0.8
9.52 (3/8)	0.8
12.70 (1/2)	0.8
15.88 (5/8)	1.0
19.05 (3/4)	1.2

### 3.2. Pipe requirement

#### ⚠ CAUTION

Refer to the installation manual of the outdoor unit for description of the length of connecting pipe or for difference of its elevation.

Diameter [mm (in.)]	Liquid	9.52 (3/8)
	Gas	15.88 (5/8)

- Use pipe with water-resistant heat insulation.

#### ⚠ CAUTION

Install heat insulation around both the gas and liquid pipes. Failure to do so may cause water leaks.

Use heat insulation with heat resistance above 120 °C. (Reverse cycle model only)

In addition, if the humidity level at the installation location of the refrigerant piping is expected to exceed 70 %, install heat insulation around the refrigerant piping.

If the expected humidity level is 70-80 %, use heat insulation that is 15 mm or thicker and if the expected humidity exceeds 80 %, use heat insulation that is 20 mm or thicker. If heat insulation is used that is not as thick as specified, condensation may form on the surface of the insulation.

In addition, use heat insulation with heat conductivity of 0.045 W/(m·K) or less (at 20 °C).

### 3.3. Electrical requirement

The indoor unit is powered from the outdoor unit. Do not power indoor unit from separate power source.

#### ⚠ WARNING

Standard for electrical wiring and equipment differs in each country or region. Before you start electrical working, confirm related regulations, codes, or standards.

Cable	Conductor size (mm <sup>2</sup> )	Type	Remarks
Connection cable	1.5 (MIN.)	Type 60245 IEC57	3Wire+Earth (Ground), 1φ 230V

Max. Cable Length: Limit voltage drop to less than 2%. Increase cable gauge if voltage drop is 2% or more.

Cable	Conductor size (mm <sup>2</sup> )	Type	Remarks
Remote controller cable (2-wire type)	0.33 to 1.25	Use Sheathed PVC cable (locally purchased) in accordance with the regional cable standard.	Non-polar 2-wired, twisted pair
Remote controller cable (3-wire type)	0.33		Polar 3-wired

## 4. INSTALLATION WORK

#### ⚠ WARNING

Do not turn on the power until all installation work is complete.

Carrying and installation of the unit should be performed by a sufficient number of people and with sufficient equipment that is adequate for the weight of the unit. Performing such work with an insufficient number of people or with inadequate equipment could result in dropping of the unit or personal injury.

#### ⚠ CAUTION

For installation details, refer to the technical data.

### 4.1. Selecting an installation location

Decide the mounting position together with the customer as follows.

#### ⚠ WARNING

Select installation locations that can properly support the weight of the indoor unit and which will not amplify sound or vibration. If the installation location is not strong enough, the indoor unit may fall and cause injuries.

Install the units securely so that they do not topple or fall.

#### ⚠ CAUTION

Do not install the indoor unit in the following areas:

- Area with high salt content, such as at the seaside.  
It will deteriorate metal parts, causing the parts to fall or the unit to leak water.
- Area filled with mineral oil or containing a large amount of splashed oil or steam, such as a kitchen.  
It will deteriorate plastic parts, causing the parts to fall or the unit to leak water.
- Area that generates substances that adversely affect the equipment, such as sulfuric gas, chlorine gas, acid, or alkali. It will cause the copper pipes and brazed joints to corrode, which can cause refrigerant leakage.
- Area that can cause combustible gas to leak, contains suspended carbon fibers or flammable dust, or volatile inflammables such as paint thinner or gasoline. If gas leaks and settles around the unit, it can cause a fire.
- Area where animals may urinate on the unit or ammonia may be generated.

Do not use the unit for special purposes, such as storing food, raising animals, growing plants, or preserving precision devices or art objects. It can degrade the quality of the preserved or stored objects.

Do not install where there is the danger of combustible gas leakage.

Do not install the unit near a source of heat, steam, or flammable gas.

Install the unit where drainage does not cause any trouble.

Install the indoor unit, outdoor unit, power supply cable, transmission cable, and remote control cable at least 1 m away from a television or radio receivers. The purpose of this is to prevent TV reception interference or radio noise.  
(Even if they are installed more than 1 m apart, you could still receive noise under some signal conditions.)

Install the unit where ambient temperature does not reach 60°C or more.  
Take a measure such as ventilation for an environment in which heat is retained.

If children under 10 years old may approach the unit, take preventive measures so that they cannot reach the unit.

- (1) The inlet and outlet ports should not be obstructed; the air should be able to blow all over the room.
- (2) Leave the space required to service the air conditioner.
- (3) Install the unit where connection to the outdoor unit is easy.
- (4) Install the unit where the connection pipe can be easily installed.
- (5) Install the unit where the drain pipe can be easily installed.
- (6) Install the unit where noise and vibrations are not amplified.
- (7) Take servicing, etc., into consideration and leave the spaces. Also install the unit where the filter can be removed.
- (8) Do not install the unit where it will be exposed to direct sunlight.

Correct initial installation location is important because it is difficult to move unit after it is installed.

### 4.2. Installation dimension

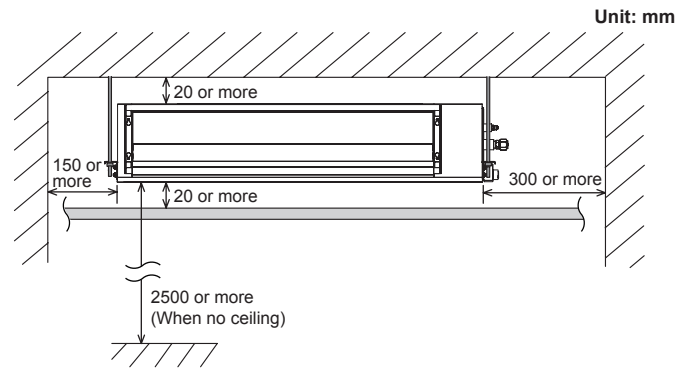

Provide a service access for maintenance purposes.

(Bottom side)

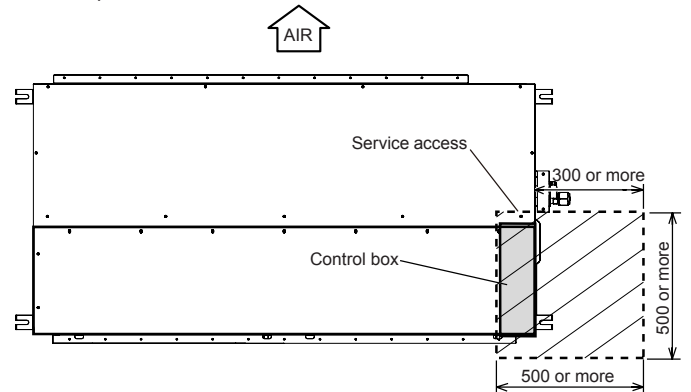

\* The service access necessary for fan units and filter maintenance.

(Bottom side)

Unit: mm

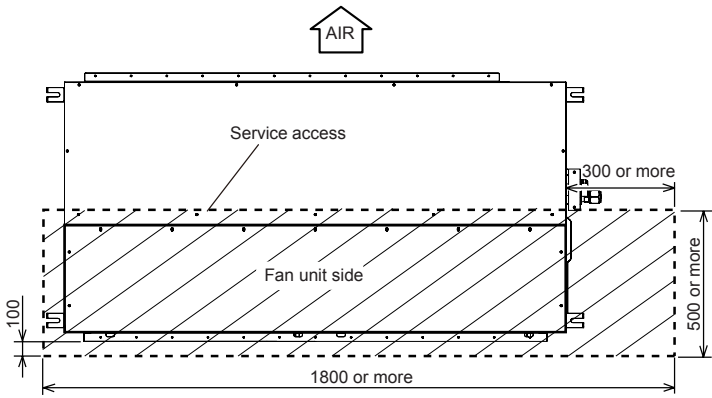

### 4.3. Installing the unit

#### ⚠ WARNING

Carrying and installation of the unit should be performed by a sufficient number of people and with sufficient equipment that is adequate for the weight of the unit. Performing such work with an insufficient number of people or with inadequate equipment could result in dropping of the unit or personal injury.

If the job is done with the panel frame only, there is a risk that the unit will come loose. Please take care.

When fastening the hangers, make the bolt positions uniform.

#### ⚠ CAUTION

Confirm the directions of the air intake and outlet before installing the unit. The unit takes in air from the evaporator side, and expels it from the fan side.

Hanging bolt installation diagram.

(Top side)

Unit: mm

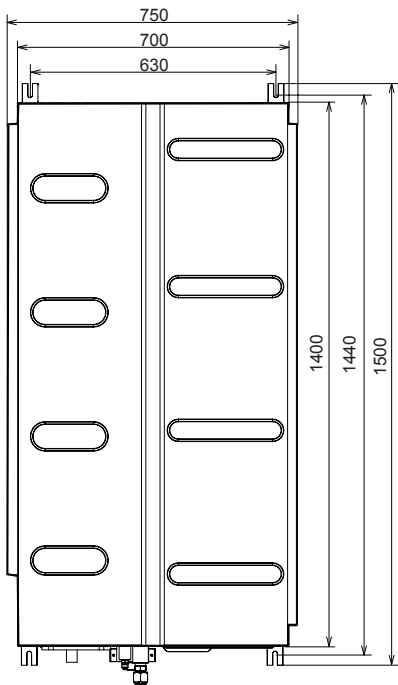

(Right side)

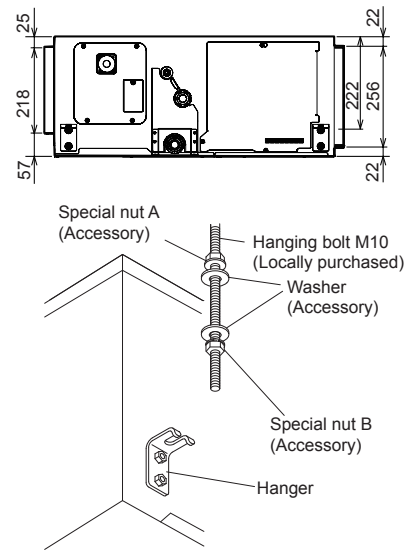

<b>Bolt Strength</b>	9.81 to 14.71 N·m (100 to 150 kgf·cm)
----------------------	---------------------------------------

#### ⚠ CAUTION

Fasten the unit securely with special nuts A and B so that the unit does not fall.

#### 4.3.1. Leveling

Base vertical direction leveling on the unit (right and left).

(Right side)

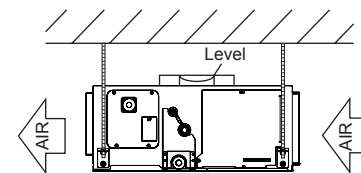

Base horizontal direction leveling on top of the unit.

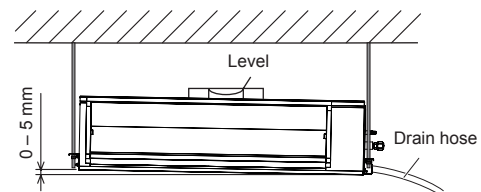

Give a slight tilt to the side to which the drain hose is connected. The tilt should be in the range of 0 mm to 5 mm.

#### 4. 4. Installing the drain hose

##### CAUTION

Install the drain hose in accordance with the instructions in this installation manual and keep the area warm enough to prevent condensation. Problems with the piping may lead to water leaks.

Be sure to properly insulate the drain hose so that the water will not drip from the connected parts.

The position of the installed drain hose should have a downward gradient of 1/100 or more.

Do not connect the drain hose in which ammonia or other types of gas affecting the unit is generated. Heat exchange erosion may occur.

Install the drain hose according to the measurements given in the following figure.

(Right side)

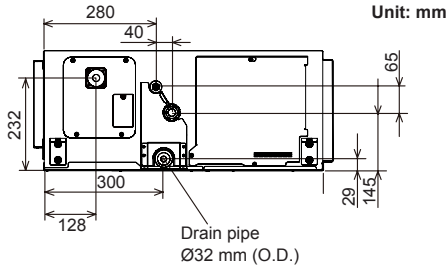

##### 4. 4. 1. How to install the drain hose

- Install the drain hose (accessory) to the drain port of the indoor unit. Attach the hose band around the hose within the dimension shown. Secure firmly with the hose band.
- Attach the drain pipe (locally purchased). Use general hard polyvinyl chloride pipe (VP25) [outside diameter 38 mm] and connect it with adhesive (polyvinyl chloride) so that there is no leakage.
- Check the drainage.
- Wrap the drain hose insulation around the drain hose connection.

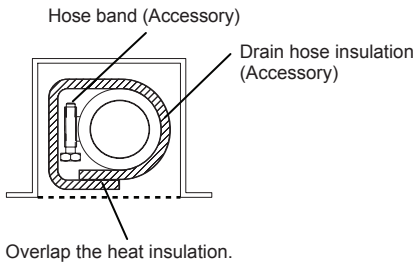
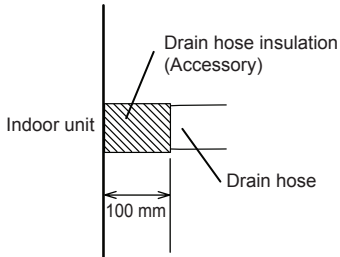
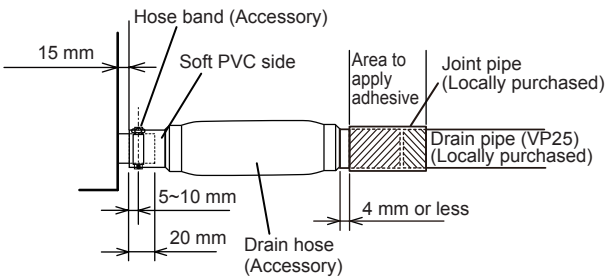

##### 4. 4. 2. When drain pump is used

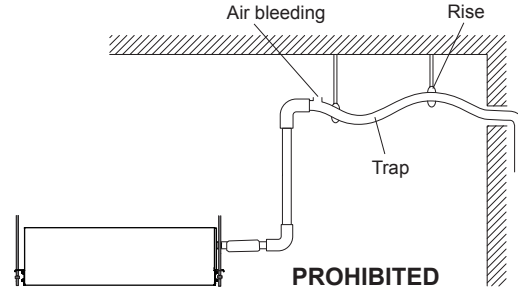
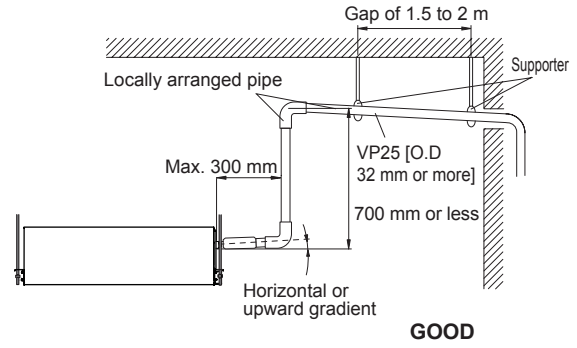

Observe the following procedures to construct centralized drain pipe fittings.

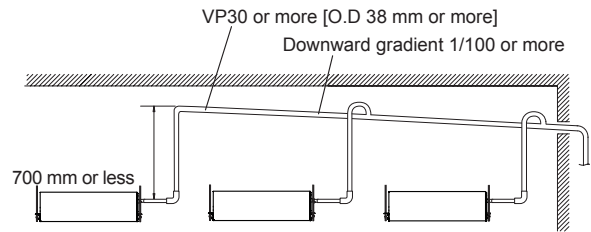

##### 4. 4. 3. When drain pump is not used (Natural drainage)

If the drain pump is not used, please move the position of the drain cap and insulation.

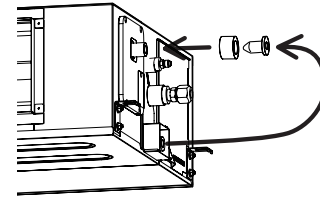

##### NOTE:

- Install the drain pipe with downward gradient (1/50 to 1/100) and so there are no rises or traps in the pipe.

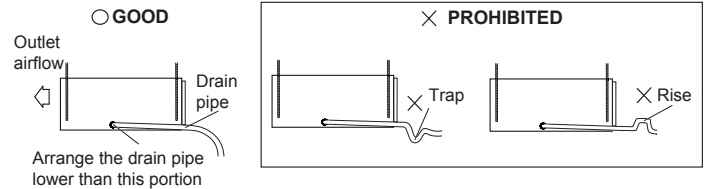

- When the pipe is long, install supporters.

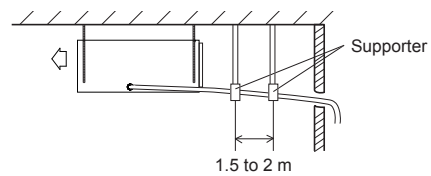

- Do not perform air bleeding.

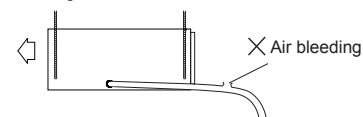



#### 4. 5. Intake duct connection

Follow the procedure in the following figure.

(Back side)

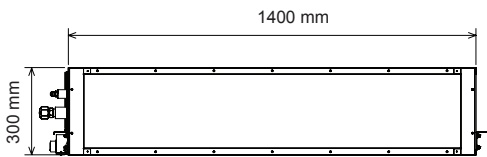

The air inlet duct can be changed by replacing the intake grille and service panel.

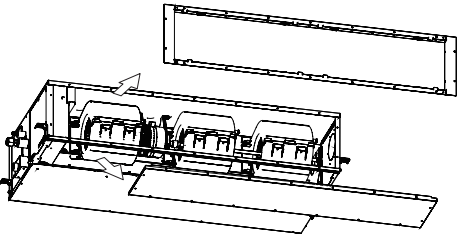

For the bottom air intake, position (1) the intake grille, and (2) the service panel, as shown in the following figure. (The factory setting is back air intake.)

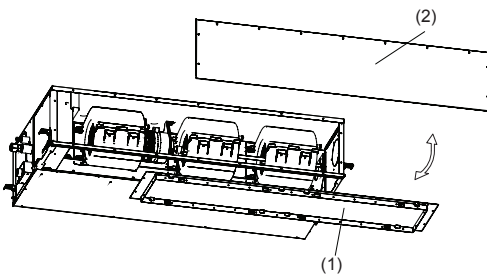

#### CAUTION

Make sure the drain water is properly drained.

To prevent people from touching the parts inside the unit, be sure to install grilles on the inlet and outlet ports. The grilles must be designed in such a way that cannot be removed without tools.

Set the appropriate external static pressure within the permissible range. (Refer to "8. FUNCTION SETTING")

If an intake duct is installed, take care not to damage the temperature sensor (the temperature sensor is attached to the intake port flange).

Be sure to install the air inlet grille and air outlet grille for air circulation. The correct temperature cannot be detected.

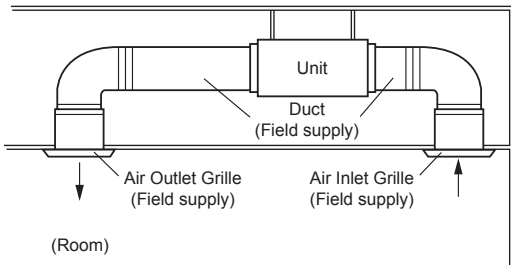

When connecting the duct, perform duct-insulation appropriate for the installing environment. Inappropriate insulation work may cause condensation on the surface of the insulating material, and may lead to condensation dripping.

#### 4. 6. Fresh air intake

(Processing before use)

- (1) When taking in fresh air, cut out the slit of the cabinet on the left side of the outer case with nippers.

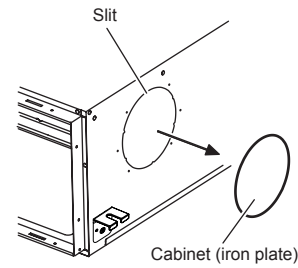

#### CAUTION

When removing the cabinet (iron plate), be careful not to damage the indoor unit internal parts and surrounding area (outer case).

When processing the cabinet (iron plate), be careful not to injure yourself with burrs, etc.

- (2) Install the round flange to the fresh air intake.

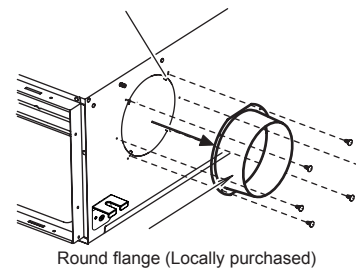

- (3) Connect the duct to the round flange.

- (4) Seal with a band and vinyl tape, etc. so that air does not leak from the connection.

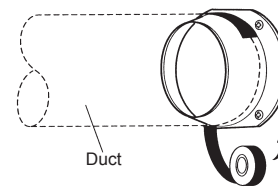

#### 5. PIPE INSTALLATION

#### WARNING

During installation, make sure that the refrigerant pipe is attached firmly before you run the compressor. Do not operate the compressor under the condition of refrigerant piping not attached properly with 2-way or 3-way valve open. This may cause abnormal pressure in the refrigeration cycle that leads to breakage and even injury.

During the pump-down operation, make sure that the compressor is turned off before you remove the refrigerant piping. Do not remove the connection pipe while the compressor is in operation with 2-way or 3-way valve open. This may cause abnormal pressure in the refrigeration cycle that leads to breakage and even injury.

When installing and relocating the air conditioner, do not mix gases other than the specified refrigerant (R410A) to enter the refrigerant cycle. If air or other gas enters the refrigerant cycle, the pressure inside the cycle will rise to an abnormally high value and cause breakage, injury, etc.

If refrigerant leaks while work is being carried out, ventilate the area. If the refrigerant comes in contact with a flame, it produces a toxic gas.

#### CAUTION

Be more careful so that foreign matter (oil, water, etc.) does not enter the piping than with refrigerant R410A models. Also, when storing the piping, securely seal the openings by pinching, taping, etc.

While brazing the pipes, be sure to blow dry nitrogen gas through them.

## 5. 1. Flare connection (pipe connection)

### 5. 1. 1. Flaring

- Use special pipe cutter and flare tool exclusive for R410A.
- (1) Cut the connection pipe to the necessary length with a pipe cutter.
- (2) Hold the pipe downward so that cuttings will not enter the pipe and remove any burrs.
- (3) Insert the flare nut (always use the flare nut attached to the indoor and outdoor units respectively) onto the pipe and perform the flare processing with a flare tool. Use the special R410A flare tool, or the conventional flare tool. Leakage of refrigerant may result if other flare nuts are used.
- (4) Protect the pipes by pinching them or with tape to prevent dust, dirt, or water from entering the pipes.

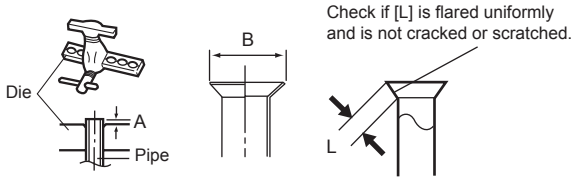

Pipe outside diameter [mm (in.)]	Dimension A [mm]	Dimension B <sub>0.4</sub> [mm]
	Flare tool for R410A, clutch type	
6.35 (1/4)	0 to 0.5	9.1
9.52 (3/8)		13.2
12.70 (1/2)		16.6
15.88 (5/8)		19.7
19.05 (3/4)		24.0

When using conventional flare tools to flare R410A pipes, the dimension A should be approximately 0.5 mm more than indicated in the table (for flaring with R410A flare tools) to achieve the specified flaring. Use a thickness gauge to measure the dimension A.

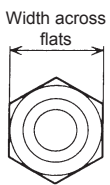

Pipe outside diameter [mm (in.)]	Width across flats of Flare nut [mm]
6.35 (1/4)	17
9.52 (3/8)	22
12.70 (1/2)	26
15.88 (5/8)	29
19.05 (3/4)	36

### 5. 1. 2. Bending pipes

- If pipes are shaped by hand, be careful not to collapse them.
- Do not bend the pipes in an angle more than 90°.
- When pipes are repeatedly bend or stretched, the material will harden, making it difficult to bend or stretch them any more.
- Do not bend or stretch the pipes more than 3 times.

#### ⚠ CAUTION

To prevent breaking of the pipe, avoid sharp bends. Bend the pipe with a radius of curvature of 150 mm or over.

If the pipe is bent repeatedly at the same place, it will break.

### 5. 1. 3. Connecting pipes

#### ⚠ CAUTION

Be sure to apply the pipe against the port on the indoor unit correctly. If the centering is improper, the flare nut cannot be tightened smoothly. If the flare nut is forced to turn, the threads will be damaged.

Do not remove the flare nut from the indoor unit pipe until immediately before connecting the connection pipe.

Do not use mineral oil on flared part. Prevent mineral oil from getting into the system as this would reduce the lifetime of the units.

- (1) Detach the caps and plugs from the pipes.
- (2) Centering the pipe against port on the indoor unit, turn the flare nut with your hand.
- (3) When the flare nut is tightened properly by your hand, hold the body side coupling with a separate spanner, then tighten with a torque wrench. (See the table below for the flare nut tightening torques.)

#### ⚠ CAUTION

Hold the torque wrench at its grip, keeping it in the right angle with the pipe, in order to tighten the flare nut correctly.

Tighten the flare nuts with a torque wrench using the specified tightening method. Otherwise, the flare nuts could break after a prolonged period, causing refrigerant to leak and generate a hazardous gas if the refrigerant comes into contact with a flame.

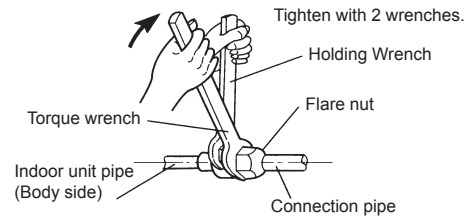

Flare nut [mm (in.)]	Tightening torque [N·m (kgf·cm)]
6.35 (1/4) dia.	16 to 18 (160 to 180)
9.52 (3/8) dia.	32 to 42 (320 to 420)
12.70 (1/2) dia.	49 to 61 (490 to 610)
15.88 (5/8) dia.	63 to 75 (630 to 750)
19.05 (3/4) dia.	90 to 110 (900 to 1,100)

## 5. 2. Installing heat insulation

Install the heat insulation material after performing a refrigerant leak check (see the installation manual for the outdoor unit for details).

### 5. 2. 1. Coupler heat insulation

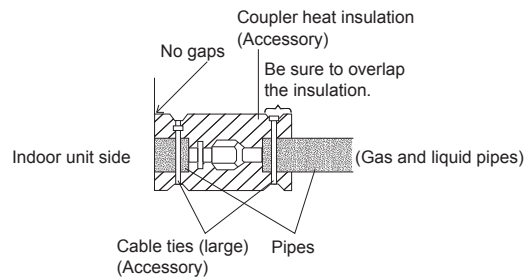

#### ⚠ CAUTION

There should be no gaps between the insulation and the product.

#### ⚠ CAUTION

After connecting the piping, check the all joints for gas leakage with gas leak detector.

Once the pressure checking has been completed using nitrogen, please refer to the outdoor unit installation manual to complete the evacuation process.

Install heat insulation around both the large (gas) and small (liquid) pipes. Failure to do so may cause water leaks.



## 6. ELECTRICAL WIRING

### ⚠ WARNING

Electrical work must be performed in accordance with this Manual by a person certified under the national or regional regulations. Be sure to use a dedicated circuit for the unit.

An insufficient power supply circuit or improperly performed electrical work can cause serious accidents such as electric shock or fire.

Before starting work, check that power is not being supplied to the indoor unit and outdoor unit.

Use the included connection cables and power cables or ones specified by the manufacturer. Improper connections, insufficient insulation, or exceeding the allowable current can cause electric shock or fire.

For wiring, use the prescribed type of cables, connect them securely, making sure that there are no external forces of the cables applied to the terminal connections. Improperly connected or secured cables can cause serious accidents such as overheating the terminals, electric shock, or fire.

Do not modify the power cables, use extension cables, or use any branches in the wiring. Improper connections, insufficient insulation, or exceeding the allowable current can cause electric shock or fire.

Match the terminal board numbers and connection cable colors with those of the outdoor unit. Erroneous wiring may cause burning of the electric parts.

Securely connect the connection cables to the terminal board. In addition, secure the cables with wiring holders. Improper connections, either in the wiring or at the ends of the wiring, can cause a malfunction, electric shock, or fire.

Always fasten the outside covering of the connection cable with the cable clamp. (If the insulator is chafed, electric leakage may occur.)

Securely install the electrical box cover on the unit. An improperly installed electrical box cover can cause serious accidents such as electric shock or fire through exposure to dust or water.

Install sleeves into any holes made in the walls for wiring. Otherwise, a short circuit could result.

Install a ground leakage breaker. In addition, install the ground leakage breaker so that the entire AC main power supply is cut off at the same time. Otherwise, electric shock or fire could result.

Always connect the earth (ground) cable. Improper earthing (grounding) work can cause electric shocks.

Install the remote control cables so as not to be touched directly with your hand.

Perform wiring work in accordance with standards so that the air conditioner can be operated safely and positively.

Connect the connection cable firmly to the terminal board. Imperfect installation may cause a fire.

### ⚠ CAUTION

Ground the unit.  
Do not connect the earth (ground) cable to a gas pipe, water pipe, lightning rod, or a telephone earth (ground) cable.  
Improper earthing (grounding) may cause electric shocks.

Do not connect power supply cables to the transmission or remote control terminals, as this will damage the product.

Never bundle the power supply cable and transmission cable together. Bundling these cables together will cause miss operation.

When handling PCB, static electricity charged in the body may cause malfunction of the PCB. Follow the cautions below:

- Establish a ground for the indoor and outdoor units and peripheral devices.
- Cut power (breaker) off.
- Touch metal part of the indoor and outdoor units for more than 10 seconds to discharge static electricity charged in the body.
- Do not touch terminals of parts and patterns implemented on PCB.

## 6. 1. Wiring method

### 6. 1. 1. Connection diagrams

- Connection cable (to outdoor unit)

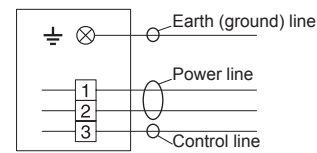

- Wired remote controller cable

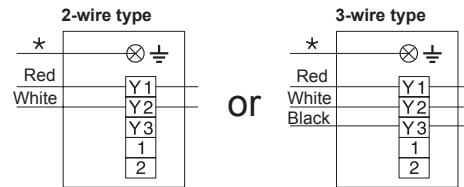

### 6. 1. 2. Connection cable preparation

Keep the earth (ground) wire longer than the other wires.

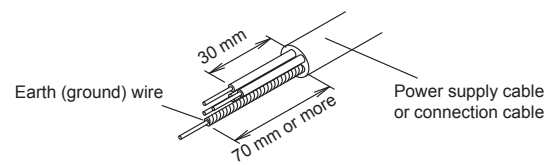

- Use a 4-core wire cable.

### How to connect wiring to the terminals.

- (1) Use ring terminals with insulating sleeves as shown in the figure below to connect to the terminal block.
- (2) Securely crimp the ring terminals to the wires using an appropriate tool so that the wires do not come loose.

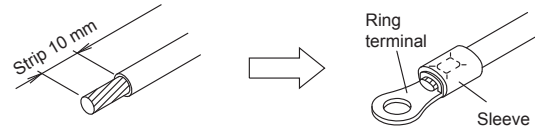

- (3) Use the specified wires, connect them securely, and fasten them so that there is no stress placed on the terminals.
- (4) Use an appropriate screwdriver to tighten the terminal screws. Do not use a screwdriver that is too small, otherwise, the screw heads may be damaged and prevent the screws from being properly tightened.
- (5) Do not tighten the terminal screws too much, otherwise, the screws may break.
- (6) See the table below for the terminal screw tightening torques.

### ⚠ WARNING

Use ring terminals and tighten the terminal screws to the specified torques, otherwise, abnormal overheating may be produced and possibly cause serious damage inside the unit.

#### Tightening torque [N·m (kgf·cm)]

M4 screw	1.2 to 1.8 (12 to 18)
M5 screw	2.0 to 3.0 (20 to 30)

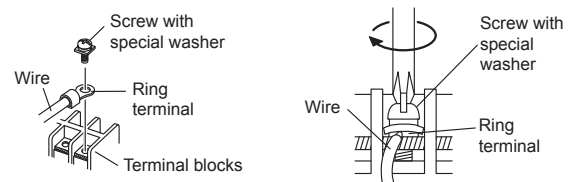

### 6.1.3. Connection wiring

#### CAUTION

Be careful not to mistake the power supply cable and connection wires when installing.

Install so that the wires for the remote controller will not come in contact with other connection wires.

- Remove the control box cover and install each connection wire.

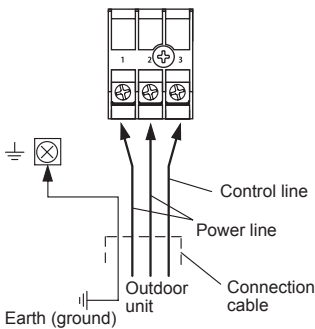
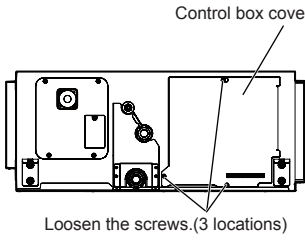

\*Ground the remote controller if it has a earth (ground) wire.

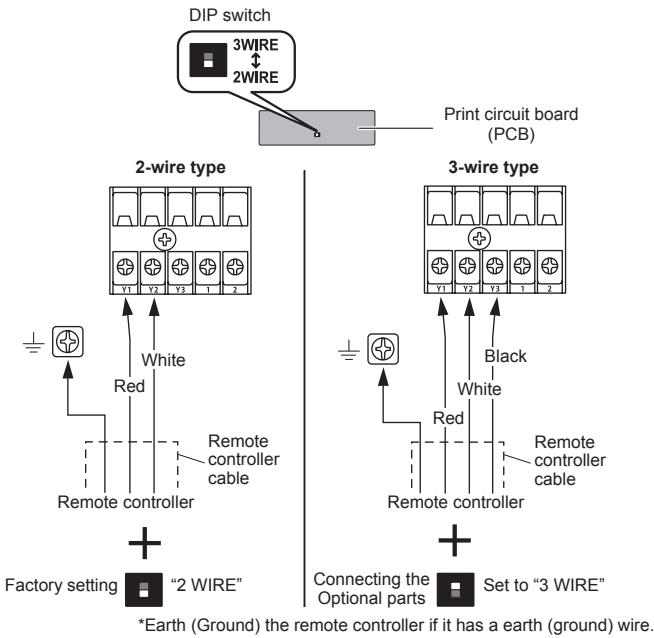

- After wiring is complete, secure the remote controller cable, connection cable, and power supply cable with the cable clamps.

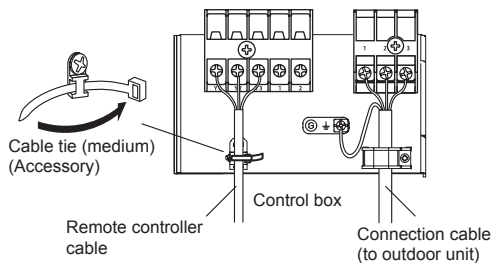

- Seal the cable outlet or other gaps with putty to prevent dew condensation or insect from entering the electric control box.
- Replace the control box cover.

#### CAUTION

Do not bundle the remote controller cable, or wire the remote controller cable in parallel, with the indoor unit connection wire (to the outdoor unit) and the power supply cable. It may cause erroneous operation.

## 7. REMOTE CONTROLLER SETTING

To install and set the remote controller, refer to the installation manual of the remote controller (wired type).

## 8. FUNCTION SETTING

To change the function settings, refer to the procedures described in the installation manual of the remote controller (wired type). The function settings are as follows.

### 8.1. Function details

#### Filter sign

Select appropriate intervals for displaying the filter sign on the indoor unit according to the estimated amount of dust in the air of the room.

If the indication is not required, select "No indication" (03).

(◆... Factory setting)

Function Number	Setting Value	Setting Description
11	00	Standard (2500 hours)
	01	Long interval (4400 hours)
	02	Short interval (1250 hours)
	03	No indication

#### Room temperature control for indoor unit sensor

Depending on the installed environment, correction of the room temperature sensor may be required.

Select the appropriate control setting according to the installed environment.

The temperature correction values show the difference from the Standard setting "00" (manufacturer's recommended value).

(◆... Factory setting)

Function Number	Setting Value	Setting Description
30 (For cooling)	00	Standard setting
	01	No correction 0.0 °C (0 °F)
	02	-0.5 °C (-1 °F)
	03	-1.0 °C (-2 °F)
	04	-1.5 °C (-3 °F)
	05	-2.0 °C (-4 °F)
	06	-2.5 °C (-5 °F)
	07	-3.0 °C (-6 °F)
	08	-3.5 °C (-7 °F)
	09	-4.0 °C (-8 °F)
	10	+0.5 °C (+1 °F)
	11	+1.0 °C (+2 °F)
	12	+1.5 °C (+3 °F)
	13	+2.0 °C (+4 °F)
	14	+2.5 °C (+5 °F)
	15	+3.0 °C (+6 °F)
	16	+3.5 °C (+7 °F)
17	+4.0 °C (+8 °F)	

## Room temperature control for wired remote controller sensor

Depending on the installed environment, correction of the wire remote temperature sensor may be required.

Select the appropriate control setting according to the installed environment. To change this setting, set Function 42 to Both "01".

Ensure that the Thermo Sensor icon is displayed on the remote controller screen.

(◆... Factory setting)

Function number	Setting value	Setting description	
35 (For cooling)	36 (For heating)	00	No correction
		01	No correction 0.0 °C (0 °F)
		02	-0.5 °C (-1 °F)
		03	-1.0 °C (-2 °F)
		04	-1.5 °C (-3 °F)
		05	-2.0 °C (-4 °F)
		06	-2.5 °C (-5 °F)
		07	-3.0 °C (-6 °F)
		08	-3.5 °C (-7 °F)
	09	-4.0 °C (-8 °F)	
	10	+0.5 °C (+1 °F)	
	11	+1.0 °C (+2 °F)	
	12	+1.5 °C (+3 °F)	
	13	+2.0 °C (+4 °F)	
	14	+2.5 °C (+5 °F)	
	15	+3.0 °C (+6 °F)	
	16	+3.5 °C (+7 °F)	
17	+4.0 °C (+8 °F)		

More Cooling  
Less Heating

Less Cooling  
More Heating

## Auto restart

Enable or disable automatic restart after a power interruption.

(◆... Factory setting)

Function Number	Setting Value	Setting Description
40	00	Enable
	01	Disable

\* Auto restart is an emergency function such as for power outage etc. Do not attempt to use this function in normal operation. Be sure to operate the unit by remote controller or external device.

## Room temperature sensor switching

(Only for wireless remote controller)

When using the Wired remote controller temperature sensor, change the setting to "Both" (01).

(◆... Factory setting)

Function Number	Setting Value	Setting Description
42	00	Indoor unit
	01	Both

00: Sensor on the indoor unit is active.

01: Sensors on both indoor unit and wired remote controller are active.

\* Remote controller sensor must be turned on by using the remote controller

## Cold air prevention

\*This setting is to disable the cold air prevention function during heating operation. When disabled, the fan setting will always follow the setting on the remote controller. (Excluding defrost mode).

(◆... Factory setting)

Function Number	Setting Value	Setting Description
43	00	Enable
	01	Disable

## External input control

"Operation/Stop" mode or "Forced stop" mode can be selected.

(◆... Factory setting)

Function Number	Setting Value	Setting Description
46	00	Operation/Stop mode 1
	01	(Setting prohibited)
	02	Forced stop mode
	03	Operation/Stop mode 2

## Room temperature sensor switching (Aux.)

To use the temperature sensor on the wired remote controller only, change the setting to "Wired remote controller" (01). This function will only work if the function setting 42 is set at "Both" (01)

(◆... Factory setting)

Function Number	Setting Value	Setting Description
48	00	Both
	01	Wired remote controller

## Indoor unit fan control for energy saving for cooling

Enables or disables the power-saving function by controlling the indoor unit fan rotation when the outdoor unit is stopped during cooling operation.

(◆... Factory setting)

Function Number	Setting Value	Setting description
49	00	Disable
	01	Enable
	02	Remote controller

00: When the outdoor unit is stopped, the indoor unit fan operates continuously following the setting on the remote controller.

01: When the outdoor unit is stopped, the indoor unit fan operates intermittently at a very low speed.

02: Enable or disable this function by remote controller setting.

\*When using a wired remote controller without Indoor unit fan control for energy saving for cooling function, or when connecting a single split converter, the setting cannot be made by using the remote controller. Set to "00" or "01".

To confirm if the remote controller has this function, refer to the operating manual of each remote controller.

## Switching functions for external output terminal

Functions of the external output terminal can be switched.

(◆... Factory setting)

Function Number	Setting Value	Setting Description
60	00	Operation status
	09	Error status
	10	Fresh air control
	11	Auxiliary heater

## Setting record

- Record any changes to the settings in the following table.

Function setting	Setting Value
Filter sign	
Static pressure	
Room temperature control for indoor unit sensor	cooling heating
Room temperature control for wired remote controller sensor	cooling heating
Auto restart	
Room temperature sensor switching	
Cold air prevention	
External input control	
Room temperature sensor switching (Aux.)	
Indoor unit fan control for energy saving for cooling	
Switching functions for external output terminal	

After completing the Function Setting, be sure to turn off the power and turn it on again.

## 8.2. Static pressure

The static pressure can be set by the following 2 methods. Choose accordingly.

### a. Manual setting (Function setting)

Select the appropriate static pressure according to the installation conditions.

(◀... Factory setting)

Function Number	Setting Value	Setting Description
26	03	30 Pa
	04	40 Pa
	05	50 Pa
	06	60 Pa
	07	70 Pa
	08	80 Pa
	09	90 Pa
	10	100 Pa
	11	110 Pa
	12	120 Pa
	13	130 Pa
	14	140 Pa
	15	150 Pa
	16	160 Pa
	17	170 Pa*
	18	180 Pa*
	19	190 Pa*
	20	200 Pa*
	31	Standard (47 Pa: 36 type) (60 Pa: 45/54 type)
	32	Automatic airflow adjustment

\* The range of static pressure is different by model.

If the static pressure is set above maximum range, the setting will be the same as the maximum.

e.g. For 45/54 type models, setting "170 Pa" (17) to "200 Pa" (20) will be the same as "160 Pa" (16)

For details, see the Fan performance curve of the technical data.

Type name	Range of static pressure
36 type	30 to 200 Pa
45/54 type	30 to 160 Pa

Record the setting value of Function 26 in the Setting record table in "8.1. Function details".

### b. Automatic airflow adjustment

#### CAUTION

This function cannot be used when there is a booster fan between the ducts.

Be sure that the static pressure is within the allowed range. Incorrect setting may cause incorrect adjustment and may result in insufficient airflow or water leakage.

When the external static pressure is changeable in the installation by use of automatic changeable dampers, etc., set so that the external static pressure is the lowest.

#### NOTE

Be sure to conduct this setting before any other operation. If the motor is warm or the heat exchanger is wet, false detection may lead to incorrect adjustments.

Check if the electrical wirings and duct installations are complete.

If there is a damper installed in the system, make sure the damper is open.

Check if the air filter (optional) is attached.

If there are several inlet, outlet ports, make sure the airflow rates of each port match the designed airflow rate by adjusting the throttles.

Automatic airflow adjustment is possible by the following procedures.

- Change the setting of Function 26 to "Automatic airflow adjustment" (32).
- Run the air conditioner on Fan mode (High).
  - \* For instructions on how to operate the air conditioner, refer to the operation manual of the remote controller.
  - During Automatic airflow adjustment, the mode will be fixed at Fan mode (High). When this function is active, do not operate the Outdoor unit.
- The air conditioner will run for about 1 to 8 min. then stop automatically.
  - \* Do not change the throttles of the inlet and outlet ports during operation.
  - When used in a Group control system, the setting will take about 10 min.
- Turn the air conditioner off and on again.
- Check the setting value of Function 26 and record the obtained setting value in the following table.
  - \* If the setting value has not changed, repeat the procedure from step 1.

Function Number	Setting value
26	

#### CAUTION

If the detected setting value is not within the range of static pressure, please check and re-arrange the installation, then repeat the procedure from step 1. Incorrect setting may result in insufficient airflow or water leakage.

When the duct or outlet installations are changed after the Automatic airflow adjustment is completed, repeat the procedure from step 1.

## 9. SPECIAL INSTALLATION METHODS

#### CAUTION

Be sure to turn off the electrical breaker before making settings.

When setting DIP switches, do not touch any other parts on the circuit board directly with your bare hands.

### 9.1. Group control system

#### CAUTION

Group control is only possible between units with remote controllers of the same type. To confirm the type of remote controller, see the back of the remote controller or "2.3. Accessories".

A number of indoor units can be operated at the same time using a single remote controller.

- Connect up to 16 indoor units in a system. (indoor unit to remote controller)

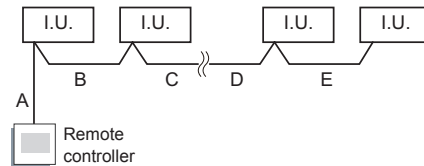

A, B, C, D, E : Remote controller cable. (Refer to "3.3. Electrical requirement")  
A+B+C+D+E ≤ 500 m.

Example of wiring method (2-wire type)

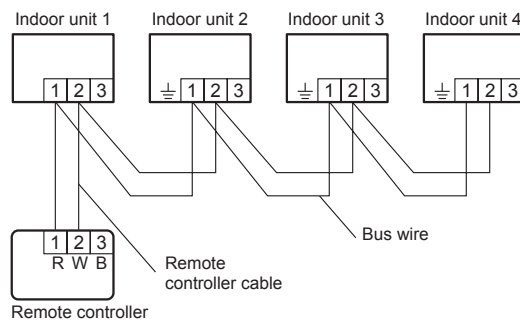

- Set the R.C. address (DIP switch setting)

Set the R.C. address of each indoor unit using the DIP switch on the indoor unit circuit board.

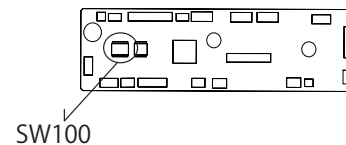

- 2-wire type

DIP switch (RC AD SW)...Factory setting "00"

Since the remote controller address settings are automatically configured, you do not need to configure them.

If configuring manually, it is necessary to configure both the indoor unit and the remote controller. For details, please refer to the remote controller installation manual.

- 3-wire type

DIP switch (RC AD SW)...Factory setting "00"

When connecting multiple indoor units to 1 standard wired remote controller, set the address at RC AD SW in sequence from "00".

Setting	Setting range	Switch 100
Remote controller address	00 to 15	Setting example 00

**Example** If 4 indoor units are connected.

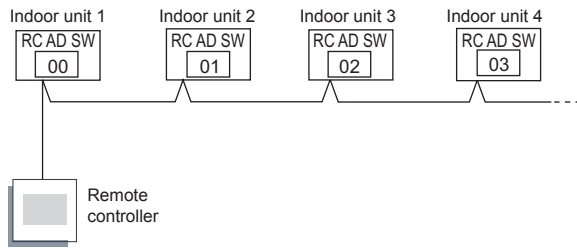

Set the R.C. address in accordance with the table below.

Indoor unit	R.C. address	DIP SWITCH No.			
		1	2	3	4
1	00	OFF	OFF	OFF	OFF
2	01	ON	OFF	OFF	OFF
3	02	OFF	ON	OFF	OFF
4	03	ON	ON	OFF	OFF
5	04	OFF	OFF	ON	OFF
6	05	ON	OFF	ON	OFF
7	06	OFF	ON	ON	OFF
8	07	ON	ON	ON	OFF
9	08	OFF	OFF	OFF	ON
10	09	ON	OFF	OFF	ON
11	10	OFF	ON	OFF	ON
12	11	ON	ON	OFF	ON
13	12	OFF	OFF	ON	ON
14	13	ON	OFF	ON	ON
15	14	OFF	ON	ON	ON
16	15	ON	ON	ON	ON

**NOTE**

Be sure to set consecutive R.C. address.  
The indoor units cannot be operated if a number is skipped.

**9. 2. Multiple remote control**

Up to 2 remote controllers can be used to operate one indoor unit

**CAUTION**

Multiple installation method described above is prohibited to combine 3 Wired type with 2 Wired Type.

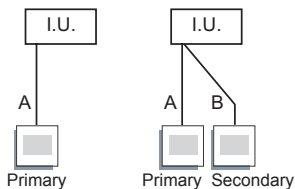

A, B : Remote controller cable. (Refer to "3.3. Electrical requirement")  
A ≤ 500 m, A+B ≤ 500 m

**9. 3. Fan delay setting**

This setting can be used when the auxiliary heater is mounted.  
When the operation is stopped when the indoor unit is operating with an auxiliary heater, the operation continues 1 minutes.  
Change the following settings by using the DIP switch.

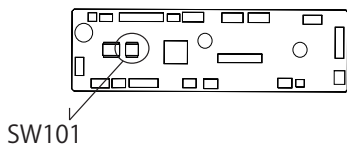

DIP switch 101	DIP SW state		Details
	ON	OFF	
1	-		Cannot be used (Do not change)
2	-		
3	Enable	Disable	Fan delay setting

**10. OPTIONAL PARTS**

**WARNING**

Regulation of cable differs from each locality, refer in accordance with local rules.

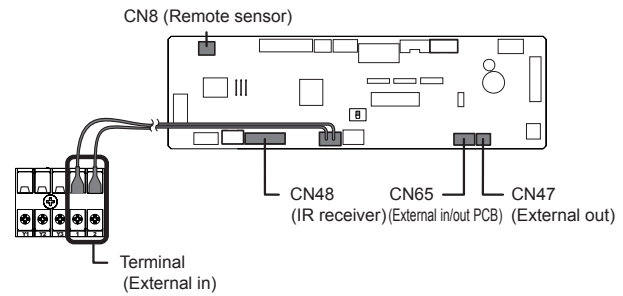

**10. 1. Optional parts**

This air conditioner can be connected with the following optional kits.  
For details on how to install optional parts, refer to the installation manual included in each item.

Option type	Connector No.
UTY-LBT*M (IR Receiver)	CN48
UTY-XSZX (Remote sensor)	CN8
UTY-XWZXZG (Connect wire)	CN47*1
UTY-XCSX (External input and output PCB)	CN65*2

\*1: For external output terminal setting, refer to Function No.60 in "8. FUNCTION SETTING".  
\*2: Various settings are available by using the optional External input and output PCB.

**10. 2. External input and output**

**10.2.1. External input**

- Indoor unit functions such as Operation/Stop or Forced stop can be done by using indoor unit terminals.
- "Operation/Stop" mode or "Forced stop" mode can be selected with function setting of indoor unit.
- A twisted pair cable (22 AWG) should be used. Maximum length of cable is 150 m (492 ft.).
- Use an external input and output cable with appropriate external dimension, depending on the number of cables to be installed.
- The wire connection should be separate from the power cable line.

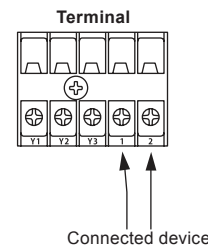

**• Dry contact terminal**

When a power supply is unnecessary at the input device you want to connect, use the Dry contact terminal.

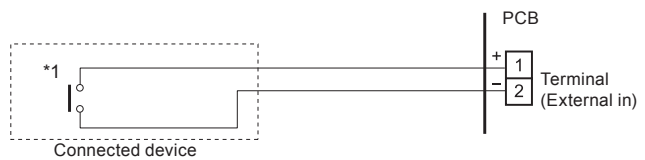

\*1: The switch can be used on the following condition: DC 12 V to 24 V, 1 mA to 15 mA.

## Operation behavior

### • Input signal type

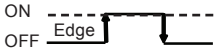

### • When function setting is "Operation/Stop" mode 1.

Input signal	Command
OFF → ON	Operation
ON → OFF	Stop

### • When function setting is "Forced stop" mode.

Input signal	Command
OFF → ON	Forced stop
ON → OFF	Normal

\* When the forced stop is triggered, indoor unit stops and Operation/Stop operation by a remote controller is restricted.

### • When function setting is "Operation/Stop" mode 2.

Input signal	Command
OFF → ON	Operation
ON → OFF	Stop (R.C. disabled)

## 10.2.2. External output

- A twisted pair cable (22AWG) should be used. Maximum length of cable is 25 m (82 ft.).
- Use an external input and output cable with appropriate external dimension, depending on the number of cables to be installed.
- Output voltage: Hi DC12V±2V, Lo 0V.
- Permissible current: 50mA

### Output select

#### • When interlocking with external device

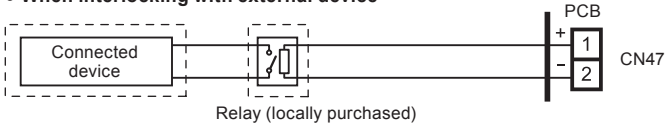

or

#### • When displaying "Operation/Stop"

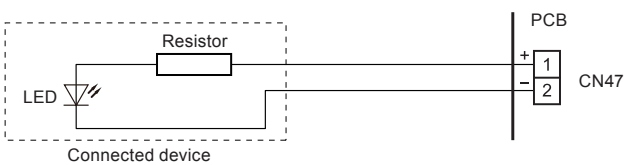

## Operation behavior

\*If function setting "60" is set to "00"

Function setting	Status	Output voltage
00	Stop	0V
	Operation	DC 12 V
09	Normal	0V
	Error	DC 12 V
10	Indoor unit fan stop	0V
	Indoor unit fan operation	DC 12 V
11	External heater OFF	0 V
	External heater ON	DC 12V

## 10.2.3. Connection methods

### Wire modification

- Remove insulation from wire attached to wire kit connector.
- Remove insulation from locally purchased cable. Use crimp type insulated butt connector to join field cable and wire kit wire.
- Connect the wire with connecting wire with solder.

**IMPORTANT:** Be sure to insulate the connection between the wires.

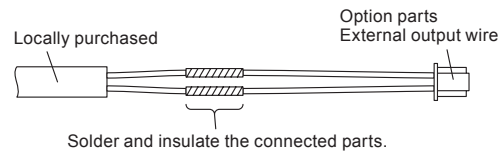

- Connecting wires to the terminals.  
Use ring terminals with insulating sleeves to connect to the terminal block.
- Connection terminals and wiring arrangement

In following figure, all the possible connections are done for description. In actual installation, connections will differ according to each installation requirements.

## 10.3. Remote sensor

### Remote sensor

- Remove the existing connector and replace it with the remote sensor connector (ensure that the correct connector is used).
- The original connector should be insulated to ensure that it does not come into contact with other electrical circuitry.

#### Setting for room temperature correction

When a remote sensor is connected, set the function setting of indoor unit as indicated below.

- Set Function Number "30" (Room temperature control for cooling) to "00"
- Set Function Number "31" (Room temperature control for heating) to "01"

## 11. CHECK LIST

Pay special attention to the check items below when installing the indoor unit(s). After installation is complete, be sure to check the following check items again.

Check items	Check box
Has the indoor unit been installed correctly?	
Has there been a check for gas leaks (refrigerant pipes)?	
Has heat insulation work been completed?	
Does water drain easily from the indoor units?	
Is the voltage of the power source the same as that indicated on the label on the indoor unit?	
Are the wires and pipes all connected completely?	
Is the indoor unit grounded?	
Is the connection cable the specified thickness?	
Are the inlets and outlets free of any obstacles?	
After installation is completed, has the proper operation and handling been explained to the user?	
Operate the unit according to the operating manual provided, and check that it is operating normally.	

### Note: Check for drainage

Pour about 1 liter of water from the position shown in the diagram or from the airflow outlet to the dew tray. Check for any abnormalities such as strange noises and whether the drain pump functions normally.

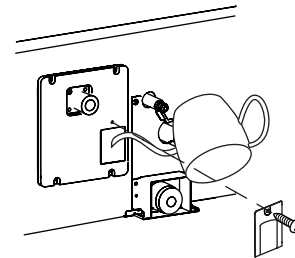

### CAUTION

Make sure the drain water is properly drained.



## 12. TEST RUN

For how to carry out the test run, refer to the installation manual of the remote controller. Check the following items:

- (1) Is operation of each button on the remote controller normal?
- (2) Do not air flow direction louvers operate normally?
- (3) Is the drain normal?
- (4) Is there any error noise and vibration during operation?

• Do not operate the air conditioner on test run for a long time.

## 13. CUSTOMER GUIDANCE

Explain the following to the customer in accordance with the operating manual:

- (1) Starting and stopping method, operation switching, temperature adjustment, timer, air flow switching, and other remote controller operations.
- (2) Cleaning and maintenance of the product, and other items such as air filters and air louvers if applicable.
- (3) Give the operating and installation manuals to the customer.
- (4) If the indoor unit custom code is changed, and the installation includes a wireless remote controller, inform the customer the changed code. (On some wireless remote controllers, the custom code may return to A when batteries are replaced.)

## 14. ERROR CODES

If you use a wired type remote controller, error codes will appear on the remote controller display. If you use a wireless remote controller, the lamps on the IR receiver unit will output error codes by way of blinking patterns. See the lamp blinking patterns and error codes in the table below. An error display is displayed only during operation.

For more details, refer to the installation manual of the remote controller.

Error display			Wired remote controller Error code	Description
OPERATION lamp (green)	TIMER lamp (orange)	ECONOMY lamp (green)		
●(1)	●(1)	◇	11	Serial communication error
●(1)	●(2)	◇	12	Wired remote controller communication error
●(1)	●(5)	◇	15	Check run unfinished Automatic airflow adjustment error
●(1)	●(6)	◇	16	Peripheral unit transmission PCB connection error
●(1)	●(8)	◇	18	External communication error
●(2)	●(1)	◇	21	Unit number or Refrigerant circuit address setting error [Simultaneous Multi]
●(2)	●(2)	◇	22	Indoor unit capacity error
●(2)	●(3)	◇	23	Combination error
●(2)	●(4)	◇	24	• Connection unit number error (indoor secondary unit) [Simultaneous Multi] • Connection unit number error (indoor unit or branch unit) [Flexible Multi]
●(2)	●(6)	◇	26	Indoor unit address setting error
●(2)	●(7)	◇	27	Primary unit, secondary unit setup error [Simultaneous Multi]
●(2)	●(9)	◇	29	Connection unit number error in wired remote controller system
●(3)	●(1)	◇	31	Power supply interruption error
●(3)	●(2)	◇	32	Indoor unit PCB model information error
●(3)	●(3)	◇	33	Indoor unit motor electricity consumption detection error
●(3)	●(5)	◇	35	Manual auto switch error
●(3)	●(9)	◇	39	Indoor unit power supply error for fan motor
●(3)	●(10)	◇	3A	Indoor unit communication circuit (wired remote controller) error
●(4)	●(1)	◇	41	Room temp. sensor error
●(4)	●(2)	◇	42	Indoor unit heat ex. middle temp. sensor error
●(4)	●(4)	◇	44	Human sensor error

Error display			Wired remote controller Error code	Description
OPERATION lamp (green)	TIMER lamp (orange)	ECONOMY lamp (green)		
●(5)	●(1)	◇	51	Indoor unit fan motor error
●(5)	●(3)	◇	53	Drain pump error
●(5)	●(7)	◇	57	Damper error
●(5)	●(15)	◇	5U	Indoor unit error
●(6)	●(1)	◇	61	Outdoor unit reverse/missing phase and wiring error
●(6)	●(2)	◇	62	Outdoor unit main PCB model information error or communication error
●(6)	●(3)	◇	63	Inverter error
●(6)	●(4)	◇	64	Active filter error, PFC circuit error
●(6)	●(5)	◇	65	Trip terminal L error
●(6)	●(8)	◇	68	Outdoor unit rush current limiting resistor temp. rise error
●(6)	●(10)	◇	6A	Display PCB microcomputers communication error
●(7)	●(1)	◇	71	Discharge temp. sensor error
●(7)	●(2)	◇	72	Compressor temp. sensor error
●(7)	●(3)	◇	73	Outdoor unit Heat Ex. liquid temp. sensor error
●(7)	●(4)	◇	74	Outdoor temp. sensor error
●(7)	●(5)	◇	75	Suction Gas temp. sensor error
●(7)	●(6)	◇	76	• 2-way valve temp. sensor error • 3-way valve temp. sensor error
●(7)	●(7)	◇	77	Heat sink temp. sensor error
●(8)	●(2)	◇	82	• Sub-cool Heat Ex. gas inlet temp. sensor error • Sub-cool Heat Ex. gas outlet temp. sensor error
●(8)	●(3)	◇	83	Liquid pipe temp. sensor error
●(8)	●(4)	◇	84	Current sensor error
●(8)	●(6)	◇	86	• Discharge pressure sensor error • Suction pressure sensor error • High pressure switch error
●(9)	●(4)	◇	94	Trip detection
●(9)	●(5)	◇	95	Compressor rotor position detection error (permanent stop)
●(9)	●(7)	◇	97	Outdoor unit fan motor 1 error
●(9)	●(8)	◇	98	Outdoor unit fan motor 2 error
●(9)	●(9)	◇	99	4-way valve error
●(9)	●(10)	◇	9A	Coil (expansion valve) error
●(10)	●(1)	◇	A1	Discharge temp. error
●(10)	●(3)	◇	A3	Compressor temp. error
●(10)	●(4)	◇	A4	High pressure error
●(10)	●(5)	◇	A5	Low pressure error
●(13)	●(2)	◇	J2	Branch boxes error [Flexible Multi]

Display mode ● : 0.5s ON / 0.5s OFF  
◇ : 0.1s ON / 0.1s OFF  
( ) : Number of flashing