

AIR CONDITIONER

Wall Mounted Type

OPERATING MANUAL



Contents

Safety Precautions	1
Indoor Unit Overview and Operations	3
Remote Controller Overview and Operations.....	4
Care and Cleaning.....	6
Troubleshooting.....	7

Before using this product, read these instructions thoroughly and keep this manual for future reference.

Safety Precautions

To prevent personal injury, or property damage, read this section carefully before you use this product, and be sure to comply following safety precautions.

Incorrect operation due to failure to follow the instructions may cause harm or damage, the seriousness of which is classified as follows:



WARNING

This mark warns of death or serious injury.



This mark denotes an action that is PROHIBITED.



CAUTION

This mark warns of injury or damage to property.



This mark denotes an action that is COMPULSORY.

• Explanation of symbols displayed on the indoor unit or outdoor unit.

	WARNING	This symbol shows that this appliance uses a flammable refrigerant. If the refrigerant is leaked and exposed to an external ignition source, there is a risk of fire.
	CAUTION	This symbol shows that the operation manual should be read carefully.
	CAUTION	This symbol shows that a service personnel should be handling this equipment with reference to the installation manual.
	CAUTION	This symbol shows that information is available such as the operating manual or installation manual.

WARNING

- | | |
|---|--|
| <ul style="list-style-type: none"> • This product contains no user-serviceable parts. Always consult authorized service personnel for repairing, installation, and relocation of this product. Improper installation or handling will cause leakage, electric shock, or fire. • In the event of a malfunction such as burning smell, immediately stop operation of the air conditioner, and disconnect all the power supply by turning off the electrical breaker or disconnecting the power plug. Then consult authorized service personnel. • Take care not to damage the power supply cable. If it is damaged, it should only be replaced by authorized service personnel. • In the event of refrigerant leakage, be sure to keep away from fire or any flammables, and consult authorized service personnel. • In the event of a thunder storm or any prior sign of a lightning strike, turn off the air conditioner via the remote controller, and refrain from touching the product or the power source to prevent any electrical hazards. • The appliance shall be stored in a room without continuously operating ignition sources (for example: open flames, an operating gas appliance or an operating electric heater). • The appliance shall be stored in a well-ventilated area. • Be aware that refrigerants may not contain an odour. • The appliance shall be stored so as to prevent mechanical damage from occurring. | <ul style="list-style-type: none"> • Disposing of the product shall be done properly, in compliance with national or regional regulations. • During transportation or relocation of the indoor unit, pipes shall be covered with the wall hook bracket for protection. Do not move the appliance by holding the indoor unit pipes. (The stress applied to the pipe joints may cause the flammable gas to leak during operation). • This appliance is not intended for use by persons (including children) with reduced physical, sensory or mental capabilities, or lack of experience and knowledge, unless they have been given supervision or instruction concerning use of the appliance by a person responsible for their safety. Children should be supervised to ensure that they do not play with the appliance. |
| <ul style="list-style-type: none"> • Do not start or stop the operation of this product by inserting or pulling out the power plug, or by turning on or off the circuit breaker. • Do not use flammable gases near this product. • Do not expose yourself directly to the cooling airflow for many hours. • Do not insert your fingers or any other objects into outlet port, open panel, or intake grille. • Do not operate with wet hands. • Do not install the unit in area filled with mineral oil such as a factory or area containing a large amount of splashed oil or steam such as a kitchen. • Do not use means to accelerate the defrosting process or to clean the appliance, other than those recommended by the manufacturer. • Do not pierce or burn. | |

[Original instructions]



PART No. 9319356143-02

En-1

English

Deutsch

Français

Español

Italiano

Ελληνικά

Português

Русский

Türkçe

Safety Precautions (continued)

⚠ CAUTION

- ❗ Provide occasional ventilation during use.
- ❗ Always operate the unit with air filters installed.
- ❗ Ensure that any electronic equipment is at least 1 m (40 in) away from either the indoor unit or outdoor unit.
- ❗ Disconnect all the power supply when you are not using this product for extended periods.
- ❗ After a long period of use, ensure to get the mounting of the indoor unit checked to prevent this product from falling down.
- ❗ The airflow direction and the room temperature should be carefully considered when you use this product in a room with infants, children, elderly or sick persons.
- ⊘ Do not direct the airflow at fireplaces or heating apparatus.
- ⊘ Do not block or cover the intake grille and the outlet port.
- ⊘ Do not apply any heavy pressure to radiator fins.
- ⊘ Do not climb on, place objects on, or hang objects from this product.
- ⊘ Do not place any other electrical products or household belongings under this product. Dripping condensation from this product might get them wet, and may cause damage or malfunction of your property.
- ⊘ Do not expose this product directly to water.
- ⊘ Do not use this product for preservation of food, plants, animals, precision equipment, art work, or other objects. This may cause quality deterioration of those items.
- ⊘ Do not expose animals or plants to the direct airflow.
- ⊘ Do not drink the drainage from the air conditioner.
- ⊘ Do not pull the power supply cable to disconnect the plug.
- ⊘ Do not touch the aluminum fins of heat exchanger built-in this product to avoid personal injury when you maintain the unit.
- ⊘ Do not stand on unstable steps when operating or cleaning this product. It may overturn and can cause injury.

This product contains fluorinated greenhouse gases.

Indoor unit accessories

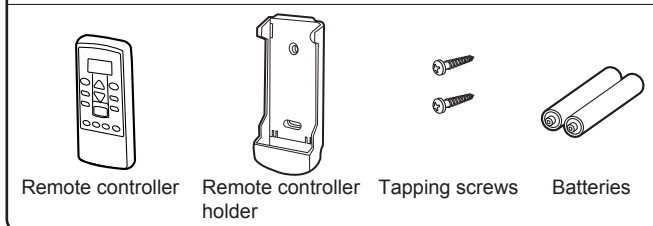

⚠ WARNING

- ❗ Take care to prevent infants and small children from accidentally swallowing the batteries.

Remote controller holder installation

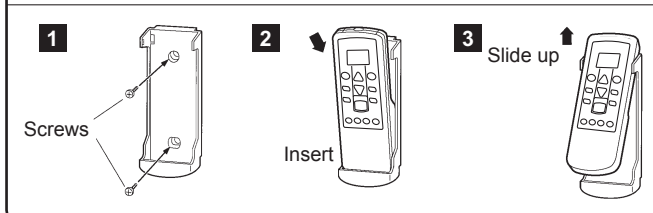

Battery (AAA/R03/LR03 × 2) loading

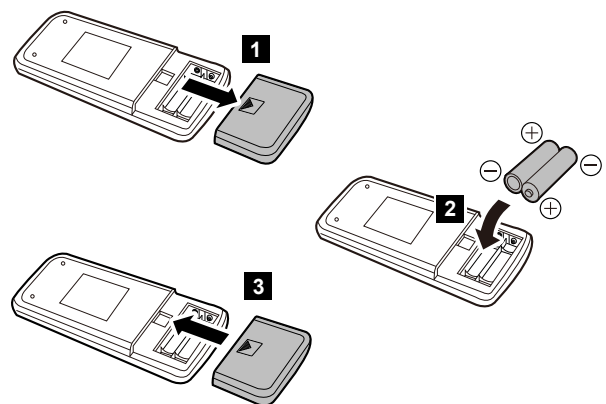

NOTES:

- Use specified type of battery only.
- Do not mix different types or new and used batteries together.
- Batteries can be used about 1 year in ordinary use.
- If the remote control range noticeably shortens, replace the batteries, and press [RESET].

Indoor Unit Overview and Operations

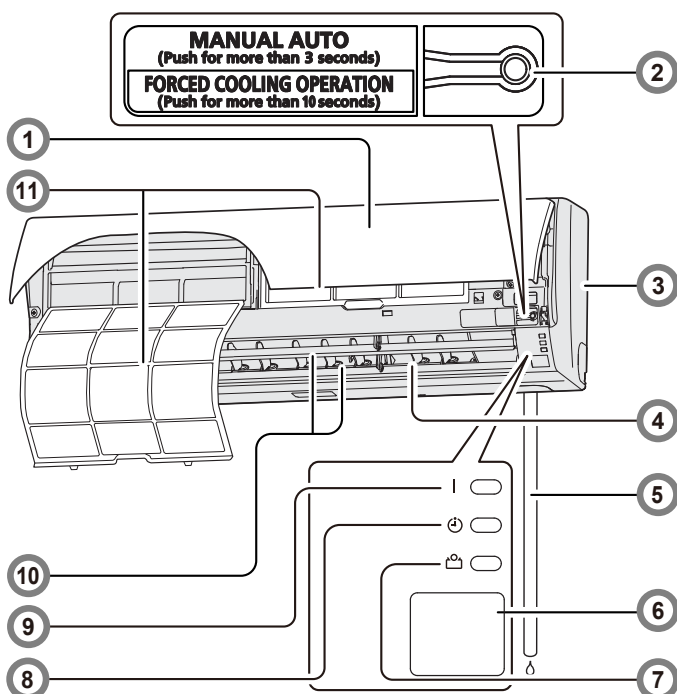

- 5 Drain hose
- 6 Remote control signal receiver

CAUTION

For appropriate signal transmission between remote controller and the indoor unit, keep the signal receiver away from following items:

- Direct sunlight or other strong light
- Flat-panel television screen

In rooms with instantaneous fluorescent lights, such as inverter type ones, the signal may not be transmitted properly. In such a case, consult the store that you purchased the product.

- 7 **[E] Economy indicator lamp (green)**
Lights in Economy operation.
- 8 **[T] Timer indicator lamp (orange)**
Lights in Timer operation, and blinks slowly when the timer setting error is detected.
As for the timer setting error, refer to "Auto-restart function" on page 5.

- 9 **[I] Operation indicator lamp (green)**
Lights in normal operation, and blinks slowly in Automatic Defrosting operation.

- 10 **Vertical airflow direction louver**
Each time you press [SET] on the remote controller, the angle of the vertical airflow direction louver moves as follows:

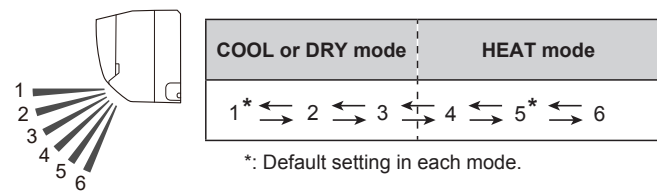

- Do not adjust by hand.
- At the beginning of AUTO or HEAT mode, they may stay position 1 for a while for adjustment.
- If you set the angle to position 4-6 for more than 30 minutes in COOL or DRY mode, they automatically return to position 3. In COOL or DRY mode, if the angle is set to position 4-6 for many hours, condensation may be formed, and the drips may wet your property.

- 11 **Air filter** » See page 6

1 Intake grille

Before starting operation, make sure that the intake grille has been shut completely. Incomplete closing might have an effect on the proper working or performance of the product.

2 [MANUAL AUTO] button

Use when you lost the remote controller or remote control malfunction occurs.

Status	Action	Mode or operation
In operation	Press more than 3 seconds.	Stop
Stopping	Press more than 3 seconds and less than 10 seconds.	Auto
	Press more than 10 seconds. (Only for servicing.*)	Forced cooling
After cleaning	Press less than 3 seconds.	Filter indicator reset

*:To stop forced cooling, press this button or [START/STOP] on the remote controller.

3 Front panel

4 Horizontal airflow direction louver

CAUTION

Before you adjust the horizontal airflow direction, make sure that the vertical airflow direction louver has been stopped completely.

Adjust two knobs by hand.

Remote Controller Overview and Operations

CAUTION

- !** To prevent malfunction or damage of the remote controller:
 - Place remote controller at where will not be exposed to direct sunlight or excessive heat.
 - Remove batteries if the product is not going to be used for an extended period.
 - Exhausted batteries must be removed immediately, and be disposed according to the local laws and regulations of your region.
- !** If leaking battery fluid comes in contact with your skin, eyes, or mouth, immediately rinse with plenty of clean water, and consult your physician.
- Obstacles such as a curtain or wall between the remote controller and the indoor unit may affect the appropriate signal transmission.
- ⊘** Do not apply strong shocks to the remote controller.
- Do not pour water on the remote controller.
- Do not attempt to recharge dry batteries.
- Do not use dry batteries that has been recharged.

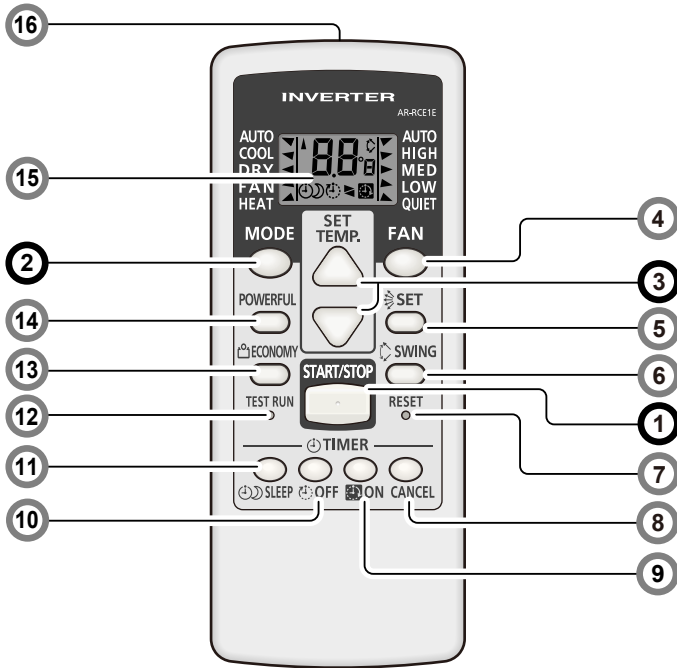

You can quickly start the operation with following 3 steps:

1 [START/STOP] button

2 [MODE] button

Switches operation mode in following order.

AUTO → COOL → DRY → FAN → HEAT

Notes in HEAT mode:

- At the beginning of the operation, the indoor unit operates at very low fan speed for about 3–5 minutes for preparation, and then switches to the selected fan speed.
- Automatic Defrosting operation overrides the heating operation when it is necessary.

Note in COOL mode:

Indoor unit fan may stop from time to time to perform indoor-unit-fan control for energy saving that enables power-saving operation by stopping the rotation of the indoor unit fan when the outdoor unit is stopped. In initial setting, this function is activated. To inactivate the function, consult the installer or authorized service personnel.

Even if the setting is changed, if the fan speed is set to "AUTO" in COOL or DRY mode, this function still works to suppress the diffusion of circulated indoor humidity.

3 [SET TEMP.] (temperature) buttons

Set desired temperature.

Temperature setting range	
AUTO	18–30 °C
COOL/DRY	18–30 °C
HEAT	16–30 °C

*:Temperature control is not available in FAN mode.

4 [FAN] button

Controls the fan speed.

AUTO → HIGH → MED → LOW → QUIET

- When AUTO is selected, the fan speed is automatically adjusted according to the operation mode.

5 [SET] button

Adjusts the vertical airflow direction.

6 [SWING] button

Starts or stops automatic swing of the vertical airflow direction louver.

- Each time you press the button, the vertical airflow direction louver swings as follows:

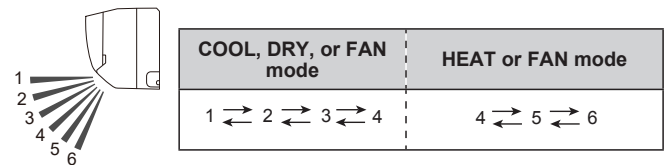

NOTES:

- Swing operation may stop temporarily when the indoor unit fan is rotating at very low speed or is stopped.
- In FAN mode, the Swing operation range of 1 ↔ 4 or 4 ↔ 6 is decided according to the airflow direction previously set before starting the Swing operation.

7 [RESET] button

When you press [RESET], press it gently by using the tip of a ballpoint pen or other small object in correct direction as shown in this figure.



8 [TIMER CANCEL] button

Cancels the set timer.

9 [ON TIMER] button

Each time you press the button, the time changes as follows:

0.5 → 1.0 → 1.5 → 2.0 → ... → 9.5 → 10 → 11 → 12 hours

- Set the time while [ON TIMER] indicator on the remote controller display is blinking.

10 [OFF TIMER] button

Each time you press the button, the time changes as follows:

0.5 → 1.0 → 1.5 → 2.0 → ... → 9.5 → 10 → 11 → 12 hours

- Set the time while [OFF TIMER] indicator on the remote controller display is blinking.



*: The setting must be done within about 3 seconds during the indicator stays solid.

! : The button is controllable only when the air conditioner is on.

Remote Controller Overview and Operations (continued)

Program timer (combined use of the On timer and the Off timer)

You can set an integrated On–Off or Off–On timer as follows:

	Set the On timer first. Then set the Off timer by the air conditioner starts operation controlled with the On timer earlier set.
	Set the Off timer first. Then set the On timer by the air conditioner stops operation controlled with the Off timer earlier set.

The timer that is set later starts counting down after the counting down of the preceding timer is finished.

NOTES:

If you change the setting value for the timer after the Program timer is set, the counting down of the timer will be reset at that moment.

11 [SLEEP TIMER] button *

Each time you press the button, the time changes as follows:



- Set the time while [SLEEP TIMER] indicator on the remote controller display is blinking.
- To repeat the timer, press the button when the indicator is not displayed.

To help you to fall asleep comfortably and prevent excessive warming or cooling in sleep, the Sleep timer controls the temperature setting automatically in accordance with the set time shown as follows. The air conditioner completely turns off after the set time has elapsed.

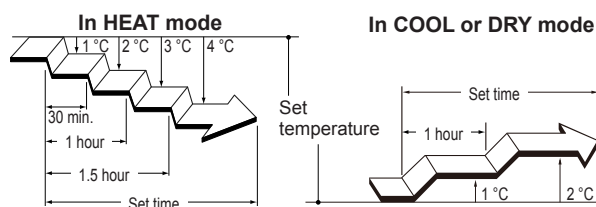

Note for Timer settings:

Any interruption of the power supply, such as a blackout or cutting off of a circuit breaker, makes the set internal clock go wrong. In such a case, [SLEEP TIMER] on the indoor unit blinks, and you need to readjust the setting.

12 [TEST RUN] button *

Only used for the initial test in the unit installation. Do not press this button under normal use because it will cause incorrect operation.

- During the test run, [TEST RUN] and [SLEEP TIMER] blink simultaneously.
- To quit the test run that is started unintentionally, you need to turn off the air conditioner by pressing [START/STOP].

13 [ECONOMY] button *

Starts or stops the Economy operation that saves more electricity consumption than the other operations with a conservative adjustment of the room temperature.

When you press the button, [ECONOMY] on the indoor unit turns on.

- In COOL mode, the room temperature will be adjusted at a few degree higher than the defined temperature.
- In HEAT mode, the room temperature will be adjusted at a few degree lower than the defined temperature.
- Especially in COOL mode, you can have improved dehumidification without significantly lowering the room temperature.

NOTES:

- In COOL or HEAT mode, the maximum output of this operation is approximately 70 % of usual air conditioning operation.
- This operation cannot be performed during temperature monitoring by AUTO mode.

14 [POWERFUL] button *

Starts the Powerful operation that enables quick cooling down or warming up of the room. When you press the button to start the Powerful operation, the indoor unit emits 2 short beeps.

The Powerful operation is automatically turned off in the following situations:

- Adjusted room temperature reached to the defined temperature in temperature setting in COOL, DRY, or HEAT mode.
- 20 minutes have passed after the Powerful operation mode has been set.

Even in situations above, the Powerful operation will not automatically turn off unless it has run for a certain amount of time.

NOTES:

- The airflow direction and the fan speed are controlled automatically.
- This operation cannot be performed simultaneously with the Economy operation.

To return to normal operation, press the button again. Then the indoor unit emits 1 short beeps.

15 Remote controller display

In this section, all the possible indicators are displayed for description. In actual operation, the display is linked with the button operation, and only shows the necessary indicators for each setting.

16 Signal transmitter

Aim to signal receiver of the indoor unit properly.

- Signal transmit indicator [▲] on the remote controller display shows that signal from the remote controller is being transmitted.
- Operating range is approximately 7 m.
- You will hear a beep if the transmitted signal has been sent properly. If there is no beep, press the button on the remote controller again.

Automatic Defrosting operation

When outdoor temperature is very low with high humidity, frost may form on the outdoor unit during the heating operation, and it could reduce the operating performance of the product.

For frost protection, a microcomputer-controlled automatic defrost function is equipped in this air conditioner.

If frost forms, the air conditioner will temporarily stop, and defrost circuit will operate briefly (maximum of 15 minutes.)

[DEFROST] on the indoor unit blinks during this operation.

If frost forms on the outdoor unit after the heating operation, the outdoor unit will stop automatically after it operates for a few minutes. Then the Automatic Defrosting operation starts.

Auto-restart function

In event of power interruption such as a blackout, the air conditioner stops once. But it restarts automatically and performs previous operation when the power supply is resumed.

If any power interruption occurs after the timer is set, counting down of the timer will be reset.

After the power supply is resumed, [SLEEP TIMER] on the indoor unit blinks to notify you that there has been a timer fault. In such a case, reset the timer for your opportune time.

Malfunctions caused by other electrical devices:

Use of other electrical appliances such as an electric shaver or nearby use of a wireless radio transmitter may cause the malfunction of the air conditioner.

If you encounter such a malfunction, turn off the circuit breaker once. Then turn it on again, and resume operation by using the remote controller.

Care and Cleaning

CAUTION

- ❗ Before cleaning this product, be sure to turn it off and disconnect all the power supply.
- Before starting operation, make sure that the intake grille has been shut completely. Incomplete closing of the intake grille might have an effect on the proper working or performance of the air conditioner.
- ⊘ Do not touch the aluminum fins of heat exchanger built-in the indoor unit to avoid personal injury when you maintain the unit.
- Do not expose the indoor unit to liquid insecticides or hair sprays.
- Do not stand on slippery, uneven or unstable surfaces when you maintain the unit.

Daily care

When cleaning the indoor unit body, mind the following:

- Do not use water hotter than 40 °C.
- Do not use scouring cleanser, volatile solvents such as benzene or thinner.
- Wipe the unit gently by using soft cloth.

Cleaning the air filters

Mind that you have a periodical cleaning of the air filters to prevent reducing the operation efficiency of the product.

Using of clogged air filter with dust will lower the product performance, and may cause airflow reduction or increase of operating noise.

Clean the air filters once every 2 weeks under normal use.

- 1 Open the intake grille in direction of the arrow.

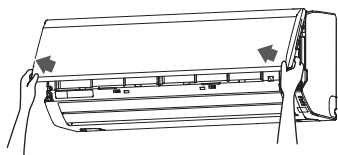

- 2 Pull up the handle of the filter in direction of the arrow and release the 2 claws.

Then pull the filter out with gently sliding it downward.

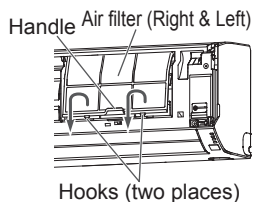

- 3 Remove dust by using a vacuum cleaner or by washing the filter. When you wash the filter, use neutral household detergent and warm water.

After rinse the filter well, dry it thoroughly in a shaded place before you reinstall it.

- 4 Attach the air filter with aligning both side of the filter with the panel.

NOTES:

Make sure that 2 claws are firmly snapped to the guide holes on the panel.

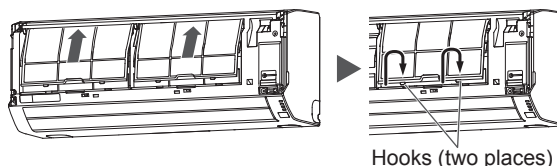

- 5 Press 4 places on the intake grille to close it completely.

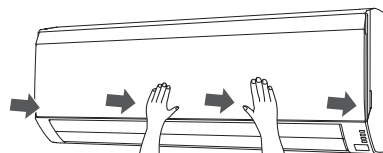

After extended non-use of the unit

If you have shut down the indoor unit for 1 month or more, perform the FAN operation for half a day to dry the internal parts thoroughly before you perform normal operation.

Additional inspection

After long period of use, accumulated dust inside the indoor unit may reduce the product performance even if you have maintained the unit with instructed daily care or cleaning procedures written in this manual. In such a case, the product inspection is recommended.

For more information, consult authorized service personnel.

Filter Indicator Reset (Special setting)

• This function can be used if set correctly during installation. Please consult authorized service personnel in order to use this function.

• Clean the air filter when the indicator lamp show the following;

[Icon]	Flashes 3 times, at intervals of 21 seconds
--------	---

After cleaning, reset the filter indicator by pushing [MANUAL AUTO] on the indoor unit for 3 seconds or less.

Troubleshooting

WARNING



In following events, immediately stop operation of the air conditioner, and disconnect all the power supply by turning off the electrical breaker or disconnect the power plug. Then consult your dealer or authorized service personnel.

As long as the unit is connected to the power supply, it is not insulated from the power supply even if the unit is turned off.

- Unit smells of something burning or emits smoke
- Water leaks from the unit

Following symptoms do not indicate the product malfunction, but they are normal functions or characteristics of this product.

Symptom	Cause	See page
Operation is delayed after restart.	To prevent blowout of the fuse, the compressor will not operate during the protection circuit is working for about 3 minutes after sudden Off→On operation of the power supply.	–
Noise is heard.	<ul style="list-style-type: none"> • During the operation or immediately after stopping the air conditioner, refrigerant flowing sound may be heard. And it is particularly noticeable for 2–3 minutes after starting operation. • During the operation, a slight squeaking sound produced by the minute expansion and contraction of the front panel caused by temperature change may be heard. 	–
	During heating operation, a sizzling sound produced by the Automatic Defrosting operation may be heard.	5
Smell coming from the unit.	Absorbed room smell generated from interior textile, furniture, or cigarette smoke into the air conditioner may be emitted.	–
Mist or steam is emitted from the unit.	In COOL or DRY mode, a thin mist generated by condensation formed with sudden cooling process may be emitted.	–
	During heating operation, the fan built-in the outdoor unit may stops and rising steam generated by the Automatic Defrosting operation may be seen.	5
Airflow is weak or stops.	<ul style="list-style-type: none"> • Immediately after the heating operation is started, the fan speed stays temporarily very low to warm up the internal parts of the unit. • In HEAT mode, the outdoor unit stops and the indoor unit operates at very low fan speed if the room temperature rises above the set temperature. 	–
	In HEAT mode, the indoor unit temporarily stops for maximum of 15 minutes to perform the Automatic Defrosting operation while [I] is flashing.	5
	In DRY mode, the indoor unit operates at low fan speed to adjust the room humidity, and may stop from time to time.	–
	When the fan speed is set to QUIET, the fan rotates at very low speed and the airflow is reduced.	–
	When monitoring operation is performed in AUTO mode, the fan rotates at very low speed.	–
Outdoor unit emits water.	During heating operation, the outdoor unit may emit water generated by the Automatic Defrosting operation.	–

When the filter sign is set, the LED lamp may flash. In this case, please refer to “Filter Indicator Reset (Special setting)”.

Before you call for or request servicing, troubleshoot a problem by performing following checks:

Symptom	Diagnostic	See page
Does not operate at all.	<input type="checkbox"/> Has the circuit breaker been turned off? <input type="checkbox"/> Has there been a power outage? <input type="checkbox"/> Has a fuse blown out or the circuit breaker been tripped?	–
	<input type="checkbox"/> Is the intake grille closed completely?	6
	<input type="checkbox"/> Is the timer operating?	4, 5
Poor cooling or heating performance.	<input type="checkbox"/> Is the air filter dirty?	6
	<input type="checkbox"/> Is the intake grille or outlet port of indoor unit blocked?	–
	<input type="checkbox"/> Is the room temperature adjusted appropriately?	4
	<input type="checkbox"/> Is a window or door left opened? <input type="checkbox"/> Is direct or strong sunlight shinning into the room in cooling operation? <input type="checkbox"/> Are there other heating apparatus or computers operating, or too many people in the room in cooling operation?	–
	<input type="checkbox"/> Is the fan speed set to QUIET?	4
The unit operates differently from the remote controller setting.	<input type="checkbox"/> Are the batteries used in the remote controller exhausted? <input type="checkbox"/> Are the batteries used in the remote controller loaded properly?	2

Immediately stop operation and turn off the electrical breaker in following cases. Then consult authorized service personnel.

- The problem persists even if you perform these checks or diagnostics.
- [I] and [Ⓢ] blink while [Ⓢ] is blinking fast.